

REFACCIÓN	AP4	AP-5X	AP-50	AP-50 X	CÓDIGO
CUERPO DE BOMBA	√				CUERPOBOM-AP4
		√			CUERPOBOM-AP5
			√	√	R-AP50XCUERPOBOMB
IMPULSOR	√	√			IMPULSOR-AP5E
			√		R-AP50IMPULSOR
				√	R-AP50XIMPULSOR
CANDADO	√	√			CANDADO-AP5
SELLO MECÁNICO			√	√	R-AP50/50XSELLOMEC
O-RING			√	√	R-AP50/50XORINGCB
BALEROS			√	√	R-AP50/50XBALERO
TAPA Y CAJA DE CONEXIONES	√				C/CAJACONEX-AP4
		√			CAJACONEX-AP5E
			√	√	R-AP50TAPACC
				√	R-AP50XCC
CAPACITOR	√				CAPAC-AP4
		√			CAPAC-AP5E
			√		R-AP50CAPACIT25MF
				√	R-AP50XCAPACIT20MF
VENTILADOR	√	√			VENTILADOR-AP5E
TAPA DE VENTILADOR	√	√			R-AP50/50XVENT
			√	√	TAPAVENT-AP5X
			√	√	R-AP50/50XTVENT
SWITCH ON/OFF				√	R-AP50XSWITCH
TUERCA PLÁSTICA		√			TUEPLAS-AP5X
TAPÓN DE CEBADO	√	√			R-AP4/AP5XTAPCEB
			√	√	R-AP50/50XTAPCEB
O-RING DE TAPÓN DE CEBADO	√	√			R-AP4/AP5XORINGTC
			√	√	R-AP50/50XORINGTC
SOPORTE SELLO MECÁNICO			√	√	R-AP50/50XSOPORSE
TORNILLO CAJA DE CONEXIONES			√	√	R-AP50TORNCC

REFACCIONES BOMBAS AP10XB

REFACCIÓN	AP-10XB-1127	CÓDIGO
CUERPO DE BOMBA	√	R-AP10XB-CB
KIT REPARACIÓN MENOR	√	R-AP10XB-KIT-REPMAN
PLATO P SELLO	√	R-AP10XB-PPORTA-SM
TAPA TRASERA	√	R-AP10XB-TAPTRAS
VENTILADOR	√	R-AP10XB-VENT
TAPA PARA VENTILADOR	√	R-AP10XB-TAPVENT
KIT CUERPO HIDRÁULICO	√	R-AP10XB-KIT-HIDRA
TAPA DE CAJA CONEXIÓN	√	R-AP10XB-TAPCC
TAPÓN DE PURGA	√	R-AP10XB-TAPP

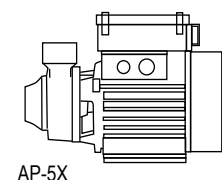
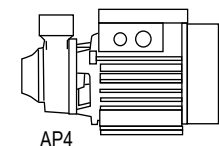
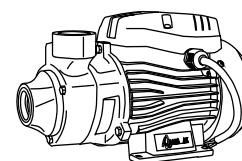

REFACCIÓN	AP-5XB-1127	AP-5XP-1127	CÓDIGO
CUERPO DE BOMBA	√	√	R-AP5XB-P-CB
TAPÓN DE CEBADO	√	√	R-AP5XB-P-TC
O-RING TAPÓN DE CEBADO	√	√	R-AP5XB-P-ORING-TC
IMPULSOR	√	√	R-AP5XB-P-IMPULSOR
SELLO MECÁNICO	√	√	R-AP5XB-P-SELLMEC
ORING CUERPO BOMBA	√	√	R-AP5XB-P-ORING-CB
SOPORTE SELLO MECÁNICO	√	√	R-AP5XB-P-SOP-SMEC
BALERO 6201	√	√	R-AP5XB-P-BALERO
TORNILLO CAJA CONEX.	√		R-AP5XB-TORN-CC
TORNILLO CAJA CONEX.		√	R-AP5XP-TORN-CCP
TAPA DE CAJA CONEXIONES	√		R-AP5XB-TAPA-CC
TAPA Y CAJA CONEXIONES		√	R-AP5XP-TAPA-CCP
CAPAC. 20UF CON TERMINAL	√		R-AP5X-CP20-TERM
CAPAC. 20UF CON CABLE		√	R-AP5X-CP20-CABLE
SWITCH ON/OFF		√	R-AP5XP-SW
VENTILADOR	√	√	R-AP5XB-P-VENT
TAPA DE VENTILADOR	√	√	R-AP5XB-P-TAPVENT

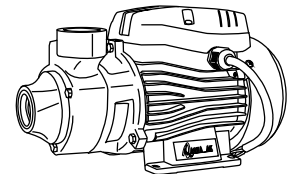

REFACCIONES MOTOBOMBAS CFB

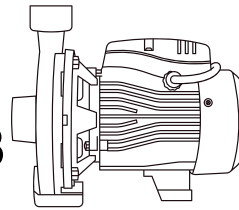

REFACCIÓN	AQ-CFB50-1127	AQ-CFB75-1127	AQ-CFB100-1127	AQ-CFB150-1127	AQ-CFB200-1127	CÓDIGO
TAPÓN CEBADO INFERIOR	√	√	√	√	√	R-CFB-TAPCEB-INF
EMPAQUE DE SUCCIÓN	√					R-CFB-EMPSUCC1
		√	√			R-CFB-EMPSUCC2
				√	√	R-CFB-EMPSUCC3
TAPÓN CEBADO SUPERIOR	√	√	√	√	√	R-CFB-TAPCEB-SUP
CUERPO DE BOMBA	√					R-CFB-CUEBOMB1
		√	√			R-CFB-CUEBOMB2
				√	√	R-CFB-CUEBOMB3
JUNTA TÓRICA	√					R-CFB-JTORICA1
		√	√			R-CFB-JTORICA2
				√	√	R-CFB-JTORICA3
IMPULSOR	√					R-CFB50-IMPULSOR
		√				R-CFB75-IMPULSOR
			√			R-CFB100-IMPULSOR
				√		R-CFB150-IMPULSOR
					√	R-CFB200-IMPULSOR
SELLO MECÁNICO	√					R-CFB-SELLOMEC1
		√	√			R-CFB-SELLOMEC2
				√	√	R-CFB-SELLOMEC3
PLATO PORTASELLO	√					R-CFB-PPORTA-SM1
		√	√			R-CFB-PPORTA-SM2
				√	√	R-CFB-PPORTA-SM3
BALEROS	√					R-AP50/50XBALERO
	√					R-AP10XB-BAL
		√	√			R-CFB-BALEROS
CUÑA	√	√	√	√	√	R-CFB-CUÑA
CAJA DE CONEXIONES	√					R-CFB-CCONEX1
		√	√			R-CFB-CCONEX2
				√	√	R-CFB-CCONEX3
CAPACITOR	√					R-CFB50-CAP
		√				R-CFB75-CAP
			√			R-CFB100-CAP
				√		R-CFB150-CAP
					√	R-CFB200-CAP
TAPA DE VENTILADOR	√					R-CFB-TAPVENT1
		√	√			R-CFB-TAPVENT2
				√	√	R-CFB-TAPVENT3
PIE DE BOMBAS CFB	√	√	√	√	√	R-CFB-PIEBOMBA
VENTILADOR	√					R-CFB-VENT1
		√	√			R-CFB-VENT2
				√	√	R-CFB-VENT3

REFACCIÓN	STEP60-07-3/1115	STEP80-10-3/1115	CÓDIGO
TAPÓN DE CEBADO	√	√	FIX-E/TCEBADO1/4
SUCCIÓN BOMBA	√	√	R-SUCCIONSTEP60
CUBIERTA AUTOCEBANTE	√	√	STP/CUBAUTCEBANT
IMPULSOR	√		STP60/IMPULSOR
		√	STP80/IMPULSOR
DIFUSOR	√	√	STP/DIFUSOR
TAPA DIFUSOR	√	√	STP/CUBDIFUSOR
BALERO DELANTERO	√	√	E1901
BALERO TRASERO	√		E1962
		√	E1901
VENTILADOR	√		STP60/VENT
		√	STP80/VENT
TAPA DE VENTILADOR	√		STP60/TVENT
		√	FIX10E/TVENT
CAJA DE CONEXIONES	√	√	STEP-C/CONEX
SWITCH ON/OFF	√	√	FIX-E/SWITCH
CAPACITOR	√		AQ/CAP25UF
		√	AQ/CAP30UF
SELLO MECÁNICO	√	√	STP60/SELLOMECH
JUNTA TORICA C. B.	√	√	STP/JUNTOR-CB
TIRANTE	√		R-STEP60-TIRANTE
		√	R-STEP80-TIRANTE
ORING	√	√	AQ/ORINGTC1/4
PIE DE BOMBA	√		R-STEP60-PIEBOMB
		√	R-STEP80-PIEBOMB

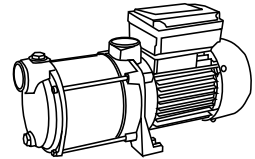

REFACCIONES TANQUES AQUAPAKPRO XLB

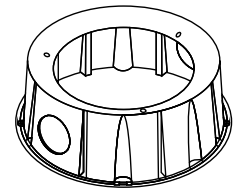
REFACCIÓN	AQUAPAKPRO XLB20	AQUAPAKPRO XLB26	AQUAPAKPRO XLB34	AQUAPAKPRO XLB52	AQUAPAKPRO XLB61	CÓDIGO
BASE	√	√				BASEAQPACPRO-20
			√	√	√	R-AQPACPROXLB-BASE

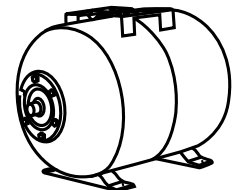

REFACCIONES TANQUES AQ24LH y AQ100LH

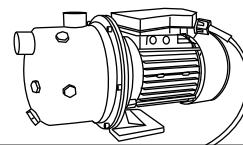
REFACCIÓN	AQ24LH/AC	AQ24LH/SS	AQ24LH/ACD	AQ50LH	AQ100LH	CÓDIGO
MEMBRANA 24L	√	√	√			MEMB-ALT24L/EPDM
MEMBRANA 50L				√		MEMB-ALT50L/EPDM
MEMBRANA 100L					√	MEMB-ALT100L/EPDM
BRIDA	√	√	√	√	√	AQ24LH/SSBRIDA

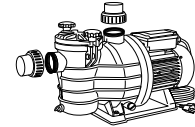

**REFACCIONES
BOMBAS FIX**

REFACCIÓN	FIX05E	FIX10E	FIX15E	FIX15E/ 3230	CÓDIGO
CUERPO DE BOMBA	√	√	√	√	R-FIX-E-CUERBOM-8T
IMPULSOR	√				FIX05E/IMPULSOR
		√			FIX10E/IMPULSOR
			√		FIX15E/IMPULSOR
				√	R-FIX15E/3-IMP
PIE DE BOMBA	√				R-FIX05E-PIEBOM-8T
		√	√	√	R-FIX10-15E-PIE-8T
VENTILADOR	√				FIX05E/VENT
		√	√	√	FIX10E/15E/VENT
TAPA DE VENTILADOR	√				FIX05E/TVENT
		√			FIX10E/TVENT
			√	√	FIX15E/TVENT
CAJA DE CONEXIONES	√	√	√		AQ/C/CONEX
CAPACITOR	√				FIX05/CAP16UF
		√			AQ/CAP25UF
			√		AQ/CAP30UF
TAPA Y CAJA CONEXIONES 3F				√	R-FIX15-3F-KITCC
TABLILLA PARA CONEXIONES 3F				√	R-FIX15-TABCONEX3F
SELLO MECÁNICO	√	√	√	√	R-FIX-NSC-SM
DIFUSOR CON INYECTOR	√				R-FIX05-DIF
		√			R-FIX10-DIF
			√	√	R-FIX15-DIF
BALEROS	√				FIX05E/BALER
		√	√	√	FIX10E/15E/BALER
JUNT. TÓRICA C.BOMBA POS.6	√	√	√	√	FIX-E/JUNTOR-CB
SWITCH ON/OFF	√	√	√		FIX-E/SWITCH
SOPORTE PORTA	√				FIX05E/SOPORTE
SELLO		√	√	√	FIX10-15E/SOPORTE
TAPÓN DE CEBADO 1/2	√	√	√	√	FIX-E/TCEBADO1/2
TAPÓN DE CEBADO 1/4	√	√	√	√	FIX-E/TCEBADO1/4
O-RING TAPÓN DE CEBADO	√	√	√	√	FIX-E/ORINGTC3/4
TIRANTE	√				FIX05E/TIRANTE
		√	√	√	FIX10E/15E/TIRAN
TORNILLO CONEXIÓN	√	√	√	√	FIX-E/TOR-C/CONX
CONECTOR SUC./DESC.N	√	√	√	√	FIX-E/CONECTOR
TORNILLO CUERPO DE BOMBA	√	√	√	√	R-FIX-E-TORN-CB

REFACCIONES BOMBAS SILVER

REFACCIÓN	SILVER 7/115	SILVER 7/1230	SILVER 10/115	SILVER 10/1230	SILVER 12/115	SILVER 12/1230	SILVER 15/115	SILVER 15/1230	CÓDIGO
AJUSTADOR DE TAPA FILTRO	√	√	√	√	√	√	√	√	R-SILVER/AJUSTA
BLOCK DE PIE DE BOMBA	√	√	√	√	√	√	√	√	R-SILVER/BLOCK
BORNE DE TERMINALES	√	√	√	√	√	√	√	√	R-SILVER/BORNE
CAJA DE CONEXIONES	√	√	√	√	√	√	√	√	R-SILVER/C.CONEX
CANDADO VENT T/HERRADURA	√	√	√	√	√	√	√	√	R-SILVER/C.VENT-B
CAPACITOR	√								R-SILV/C20MF300V
		√							R-SILV/C10MF450V
			√		√				R-SILV/C30MF300V
				√					R-SILV/C15MF450V
						√		√	R-SILV/C20MF450V
							√		R-SILV/C40MF300V
CUERPO DE BOMBA	√	√	√	√	√	√	√	√	R-SILVER/C.BOM
DIFUSOR	√	√	√	√	√	√	√	√	R-SILVER/DIFUSOR
FILTRO	√	√	√	√	√	√	√	√	R-SILVER/FILTRO
IMPULSOR CON ROSCA INTERNA	√	√							R-SILVER7/IMP
			√	√					R-SILVER10/IMP
					√	√			R-SILVER12/IMP
							√	√	R-SILVER15/IMP
IMPULSOR CON CUÑA	√	√							R-SIL-IMPUSIL7
			√	√					R-SIL-IMPUSIL10
					√	√			R-SIL-IMPUSIL12
							√	√	R-SIL-IMPUSIL15
CUÑA	√	√	√	√	√	√	√	√	R-SIL-CUÑA
O-RING PARA IMPULSOR	√	√	√	√	√	√	√	√	R-SIL-O-RINGIMPU
JUNTA DIFUSOR	√	√	√	√	√	√	√	√	R-SILVER/J.DIFUS
JUNTA TAPA DE FILTRO	√	√	√	√	√	√	√	√	R-SILVER/J.FILT
JUNTA PARA TAPÓN DESAGÜE	√	√	√	√	√	√	√	√	R-SILVER/J.T.DESAG
JUNTA TÓRICA CUERPO/BOMBA	√	√	√	√	√	√	√	√	R-SILVER/J.C.BOM
JUNTA TÓRICA RACOR	√	√	√	√	√	√	√	√	R-SILVER/J.RACOR
PIE DE BOMBA	√	√	√	√	√	√	√	√	R-SILVER/PIE
KIT DE RACOR+JUNTA TÓRICA	√	√	√	√	√	√	√	√	R-SILVER/KIT RAC
RETEN	√	√	√	√	√	√	√	√	R-SILVER/RETEN
BALERO INFERIOR	√	√	√	√	√	√	√	√	R-SILVER/BALINF
BALERO SUPERIOR	√	√	√	√	√	√	√	√	R-SILVER/BALSUP
SELLO MECÁNICO	√	√	√	√	√	√	√	√	R-SILSUP/SELLOMECH
SOPORTE PARA BALERO	√	√	√	√	√	√	√	√	R-SILVER/S.BALER
SOPORTE SUP. PORTA SELLO	√	√	√	√	√	√	√	√	R-SILVER/SOPORTE
TAPA DE FILTRO	√	√	√	√	√	√	√	√	R-SILVER/TAPAFIL
TAPA DE VENTILADOR	√	√	√	√	√	√	√	√	R-SILVER/T.VENT.
TAPÓN DE DESAGÜE	√	√	√	√	√	√	√	√	R-SILVER/T.DESAG
TORNILLO TIRANTE P/ ESTATOR	√	√	√	√	√	√	√	√	R-SILVER/T.TIRAN
TUERCA PASADOR	√	√	√	√	√	√	√	√	R-SILVER/T.PAS
VENTILADOR	√	√	√	√	√	√	√	√	R-SILVER/VENT.
RESORTE PARA TUERCA	√	√	√	√	√	√	√	√	R-SIL-RESTUERCA
TUERCA PARA IMPULSOR	√	√	√	√	√	√	√	√	R-SIL-TUERIMPU
SWITCH DE ENCENDIDO	√	√	√	√	√	√	√	√	R-SILVER15-SWE



REFACCIONES BOMBAS SUPRA

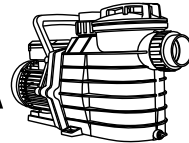

REFACCIÓN	SUPRA15/1230	SUPRA20/1230	SUPRA25/1230	SUPRA30/1230	SUPRA30/3234	CÓDIGO
ASA DE TRANSPORTE	√	√	√	√	√	R-SUPRA/ASA
BALERO INFERIOR	√	√	√	√	√	R-SUPRA/BALERINF
BALERO SUPERIOR	√	√	√	√	√	R-SUPRA/BALERSUP
BRIDA	√	√	√	√	√	R-SUPRA/BRIDA
CABLE CONECTOR	√					R-SUPRA15/CABLE
		√	√	√		R-SUPRA20-30/CAB
CAJA DE CONEXIONES	√	√	√	√		R-SUPRA/CCONEX
CAPACITOR SUPRA15 20µF/450V	√					R-SUPRA/CAP20MF
CAPACITOR SUPRA20 30µF/450V		√				R-SUPRA/CAP30MF
CAPACITOR SUPRA25 40µF/450V			√			R-SUPRA/CAP40MF
CAPACITOR SUPRA30 50µF/450V				√		R-SUPRA/CAP50MF
CUERPO DE BOMBA	√	√	√	√	√	R-SUPRA/CUEBOM
DIFUSOR	√	√	√	√	√	R-SUPRA/DIFUSOR
FIJADOR DE CAPACITOR	√	√	√	√	√	R-SUPRA/FIJADOR
IMPULSOR CON ROSCA INTERNA	√					R-SUPRA15/IMPULS
		√				R-SUPRA20/IMPULS
			√			R-SUPRA25/IMPULS
				√		R-SUPRA30/IMPULS
					√	R-SUPRA30-3F/IMP
IMPULSOR CON CUÑA	√					R-SUP-IMPUSUP150
		√				R-SUP-IMPUSUP200
			√			R-SUP-IMPUSUP250
				√		R-SUP-IMPUSUP300
JUNTA DIFUSOR	√	√	√	√	√	R-SUPRA/JUNTADIF
JUNTA IMPULSOR	√	√	√	√	√	R-SUPRA/JUNTAIMP
JUNTA TAPA DE PREFILTRO	√	√	√	√	√	R-SUPRA/JUNTAFIL
JUNTA TÓRICA	√	√	√	√	√	R-SUPRA/JUNTATOR
O-RING CAJA DE CONEXIONES	√	√	√	√		R-SUPRA/ORINGCC
					√	R-SUPRA3F/ORINGCC
PIE DE BOMBA	√	√	√	√	√	R-SUPRA/PIE
PREFILTRO	√	√	√	√	√	R-SUPRA/FILTRO
KIT DE RACOR CON JUNTA TÓRICA	√	√	√	√	√	R-SUPRA/KIT RAC
RETÉN	√	√	√	√	√	R-SUPRA/RETEN
SOPORTE INFERIOR	√	√	√	√	√	R-SUPRA/SOPINFER
SOPORTE SUPERIOR PORTA SELLO	√	√	√	√	√	R-SUPRA/SOPSUPER
SELLO MECÁNICO	√	√	√	√	√	R-SILSUP/SELLOMEC
TAPA DE CAJA DE CONEXIONES					√	R-SUPRA3F/TAPACC
TAPA DE PREFILTRO	√	√	√	√	√	R-SUPRA/TAPAFIL
TAPA DE VENTILADOR	√	√	√	√	√	R-SUPRA/TAPVENT
TIRANTES	√	√	√	√	√	R-SUPRA/TIRANTE
TUERCA PARA IMPULSOR					√	R-SUPRA30-3F/TIMP
VENTILADOR	√	√	√	√	√	R-SUPRA/VENT
CUÑA	√	√	√	√		R-SUP-CUÑA
O-RING PARA IMPULSOR	√	√	√	√		R-SUP-O-RINGIMP
RESORTE PARA TUERCA	√	√	√	√		R-SUP-RESTUERCA
TUERCA PARA IMPULSOR	√	√	√	√		R-SUP-TUERIMP
TAPÓN DE DRENADO	√	√	√	√	√	R-SUP-TAPON



REFACCIONES

BOMBAS SUPRA 3 y 4

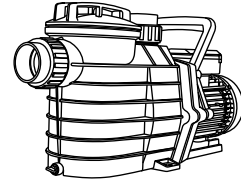

REFACCIÓN	SUPRA3 -30-1230	SUPRA3 -30-3234	SUPRA3 -40-3234	SUPRA4 -55-3234	SUPRA4 -75-3234	CÓDIGO
ARANDELA DE PRESIÓN	√	√	√			R-SUPR3-ARANPRE
				√		R-SUPR4-ARANPRE1
					√	R-SUPR4-ARANPRE2
BALERO DELANTERO	√	√	√	√		R-SUPR3/4-BALD
BALERO 6206-2RS/Z2C3					√	R-SUPR4-7.5-BALD
BALERO INFERIOR	√	√	√			R-SUPR3-34-BALINF
BALERO INFERIOR				√		R-SUPR4-5.5-BALINF
BALERO AC6206-2RS/Z2C3					√	R-SUPR4-7.5-BALINF
CAPACITOR 50MF	√					R-SUPR3-CAP50MF
CUERPO DE BOMBA	√	√	√	√	√	R-SUPR3/4-CUERPB
CUÑA	√	√	√	√	√	R-SUPRA3/4-CUÑA
EMPAQUE	√	√	√	√	√	R-SUPR3/4-EMP1
	√	√	√	√	√	R-SUPR3/4-EMP2
	√	√	√	√	√	R-SUPR3/4-EMPC
	√				√	R-SUPR3/4-EMPCC
IMPULSOR	√	√	√			R-SUPRA3-IMP
				√		R-SUPRA4-55-IMP
					√	R-SUPRA4-75-IMP
JUNTA DE SOPORTE	√	√	√	√	√	R-SUPR3/4-JSS
JUNTA TORICA	√	√	√	√	√	R-SUPR3/4-JUNTAT
KIT DRENADO	√	√	√	√	√	R-SUPR3/4-KDREN
KIT RACOR	√	√	√			R-SUPR3/4-KITRAC
				√	√	R-SUPR4-KITRAC
KIT TAPAS FRONTAL	√	√	√	√	√	R-SUPR3/4-KTAP
SELLO MECANICO	√	√	√	√	√	R-SUP3/4-SM
	√					R-SUPR3-TABCON
TABLILLA DE CONEXIÓN		√	√	√		R-SUPR3/4-TABCON3
					√	R-SUPR4-TABCON3
						R-SUPR3/4-TVENT1
TAPA DE VENTILADOR	√	√	√	√		R-SUPR3/4-TVENT1
					√	R-SUPR4-TVENT2
TAPA TRASERA	√	√	√			R-SUPR3-TAPM
				√		R-SUPR4-55-TAPM
					√	R-SUPR4-75-TAPM
TAPA Y CAJA DE CONEXIÓN	√					R-SUPR3-TAPCAJ
		√	√	√		R-SUPR3-CAJTERM
					√	R-SUPR4-TAPCAJ
TUERCA PARA IMPULSOR	√	√	√	√	√	R-SUPR3/4-TIMP
VENTILADOR	√	√	√	√		R-SUPR3/4-VENT1
					√	R-SUPR4-VENT2

REFACCIÓN	SUPRA6 -50-3234	SUPRA6 -100-3234	SUPRA6 -150-3234	SUPRA6 -200-3234	SUPRA6 -250-3234	CÓDIGO
ANILLO DE DESGASTE	√	√				R-SUP6-AN-DESG-1
			√	√	√	R-SUP6-AN-DESG-2
BALERO 6306	√	√				R-SUP6-BALERO-6306
BALERO 6308	√	√	√	√	√	R-SUP6-BALERO-6308
BALERO 6309			√	√	√	R-SUP6-BALERO-6309
CUÑA	√	√	√	√	√	R-SUP6-CUÑA
DIFUSOR	√	√				R-SUP6-DIFUSOR-1
			√	√	√	R-SUP6-DIFUSOR-2
FILTRO	√	√	√	√	√	R-SUP6-FILTRO
IMPULSOR	√					R-SUP6-IMPULSOR-1
		√				R-SUP6-IMPULSOR-2
			√			R-SUP6-IMPULSOR-3
				√		R-SUP6-IMPULSOR-4
					√	R-SUP6-IMPULSOR-5
ORING DE CUERPO DE BOMBA	√	√	√	√	√	R-SUP6-ORING-CUER
ORING DE FILTRO	√	√	√	√	√	R-SUP6-ORING-FILT
ORING DE PLATO PORTA SELLO	√	√	√	√	√	R-SUP6-ORING-PLATO
ORING DE PORTA FILTRO	√	√	√	√	√	R-SUP6-ORING-PFILT
ORING DE TORNILLO DE IMPULSOR	√	√	√	√	√	R-SUP6-ORING-TORN
ORING PARA TAPON DE CEBADO	√	√	√	√	√	R-SUP6-ORING-TAPON
SELLO MECANICO	√	√	√	√	√	R-SUP6-SELLO-MEC
TABLILLA DE CONEXIONES	√	√				R-SUP6-TAB-CONEX-1
			√	√	√	R-SUP6-TAB-CONEX-2
TAPA DE VENTILADOR	√	√				R-SUP6-TVENT-1
			√	√	√	R-SUP6-TVENT-2
TAPA TRANSPARENTE	√	√	√	√	√	R-SUP6-TAPA-TRANS
TAPA Y CAJA DE CONEXIONES	√	√	√	√	√	R-SUP6-KIT-CAJACON
TAPON DE CEBADO	√	√	√	√	√	R-SUP6-TAPON
TORNILLO DE IMPULSOR	√	√	√	√	√	R-SUP6-TORN-IMP
VENTILADOR	√	√				R-SUP6-VENT-1
			√	√	√	R-SUP6-VENT-2

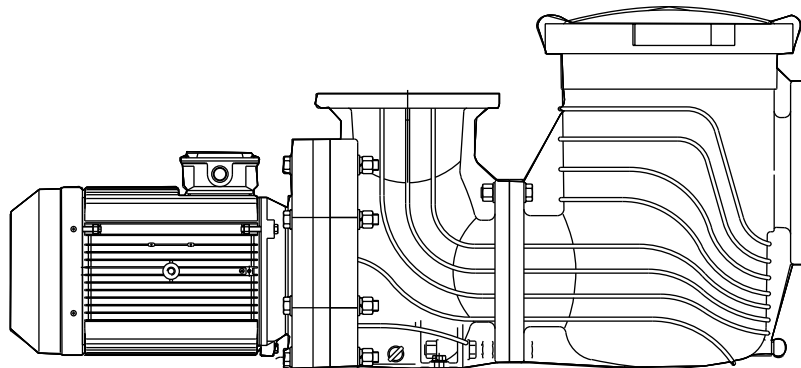

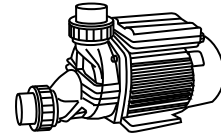

REFACCIÓN	VENUS10	VENUS15	VENUS20	VENUS25	CÓDIGO
CUERPO DE BOMBA	√	√	√	√	VENUS-CUERPOBOM
IMPULSOR	√				VENUS10-IMPULSOR
		√			VENUS15-IMPULSOR
			√		VENUS20-IMPULSOR
				√	VENUS25-IMPULSOR
SELLO MECÁNICO	√	√	√	√	VENUS-SELLOMEC
CAJA DE CONEXIONES	√	√	√	√	VENUS-CAJACONEX
CAPACITOR	√	√			VENUS-CAPAC30MF
			√		VENUS-CAPAC40MF
				√	VENUS-CAPAC50MF
SWITCH NEUMÁTICO	√	√	√	√	VENUS-SWNEUM
TAPA DE VENTILADOR	√	√	√	√	VENUS-TAPAVENT
VENTILADOR	√	√	√	√	VENUS-VENTILADOR
BALERO DELANTERO	√	√	√	√	E1900
BALERO TRASERO	√	√	√	√	E1901
VENUS RACOR DESCARGA	√	√	√	√	VENUS-RACOR/T-N
VENUS RACOR SUCCIÓN	√	√	√	√	VENUS-RACOR
PIE DE BOMBA	√	√	√	√	VENUS/PIE

REFACCIONES BOMBAS VENUS25N

REFACCIÓN	VENUS25N	CÓDIGO
RACOR	√	R-VENUSN/RACOR
CUERPO DE BOMBA	√	R-VENUSN/CUERPBOBOM
O-RING CUERPO D/BOMBA	√	R-VENUSN/ORINGCB
ANILLO IMPULSOR	√	R-VENUSN/ANILLOIMP
IMPULSOR	√	R-VENUSN/25IMPULS
SELLO MECÁNICO	√	R-VENUSN/SELLOMEC
CUBIERTA DE BOMBA	√	R-VENUSN/CUBIBOMB
CUBIERTA FRONTAL MOT	√	R-VENUSN/CUBIFRONT
BALERO DELANTERO	√	R-VENUSN/BALDELAN
BALERO TRASERO	√	R-VENUSN/BALTRASE
CAJA DE CONEXIONES	√	R-VENUSN/CAJACONEX
VENUSN 25 CAPACITOR 25mf	√	R-VENUSN/CAPAC25MF
O-RING CAJA DE CONEXIONES	√	R-VENUSN/ORINGCC
TAPA CAJA DE CONEXIONES	√	R-VENUSN/TAPACC
SWITCH NEUMÁTICO	√	R-VENUSN/SWNEUM
VENTILADOR	√	R-VENUSN/VENTILAD
TAPA DE VENTILADOR	√	R-VENUSN/TAPAVENT
BASE BOMBA	√	R-VENUSN/BASE
RACOR CONEX. "T" DESCARGA	√	R-VENUSN-T

AQUA PAK® REFACCIONES

BOMBAS NOVA

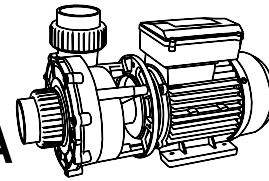

REFACCIÓN	NOVA25-1230	NOVA30-1230	CÓDIGO
ANILLO DE SELLADO	√	√	R-NOVA-ANILLO-SELL
BALERO DELANTERO	√	√	R-NOVA-BALERO-DEL
BALERO TRASERO	√	√	R-NOVA-BALERO-TRAS
CAJA DE CONEXIONES	√	√	R-NOVA-CCONEXIONES
CAPACITOR (40uf/450V)	√		R-NOVA25-CAP
CAPACITOR (50uf/450V)		√	R-NOVA30-CAP
CUBIERTA DEL CUERPO	√	√	R-NOVA-CUBIERTA-CB
CUERPO DE BOMBA	√	√	R-NOVA-CUERPO-BOMB
IMPULSOR	√		R-NOVA25-IMP
IMPULSOR		√	R-NOVA30-IMP
JUNTA TORICA	√	√	R-NOVA-JT-CB
KIT RACOR	√	√	R-NOVA-KITRACOR
SELLO MECANICO	√	√	R-NOVA-SM
TABLILLA DE CONEXION	√	√	R-NOVA-TCON
TAPA DE L VENTILADOR	√	√	R-NOVA-TVENT
TAPON DE PURGADO	√	√	R-NOVA-TAPON-PD
VENTILADOR	√	√	R-NOVA-VENT

AQUA PAK® REFACCIONES

SOPLADOR PARA HIDROMASAJE Y SPA SERIE BULLE

REFACCIÓN	BULLE400-1127	CÓDIGO
KIT RACOR PARA BULLE 400	√	R-BULLE40-KITRACOR
FILTRO BULLE 400	√	R-BULLE40-FIL
TAPA /FILTRO BULLE 400	√	R-BULLE40-TAP
KIT DE REPARACIÓN BULLE 400	√	R-BULLE40-KITREP
VALVULA CHECK /BULLE 400	√	R-BULLE40-CHEK
ESCOBILLAS/MOTOR P/BULLE 400	√	R-BULLE-ESCOBILLAS

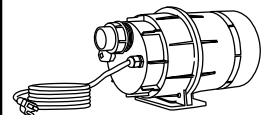

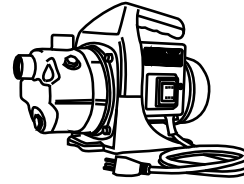

**REFACCIONES
BOMBAS PET**

REFACCIÓN	PET08 /1127	PET13 /1127	CÓDIGO
ASA	√	√	R-PET08/13-ASA
BALERO POS. DELANTERO	√	√	R-PET08/13-BDEL
BALERO POS. TRASERO	√	√	R-PET08/13-BTR
CAJA DE CONEXIONES	√	√	R-PET08/13-CCON
CANDADO DE VENTILADOR	√	√	R-PET08/13-CVENT
CAPACITOR DE 35 UF	√		R-PET08-C35UF
CAPACITOR DE 45 UF		√	R-PET13-C45UF
CUBIERTA FRONTAL DEL MOTOR	√	√	R-PET08/13-CFRO
CUBIERTA TRASERA DEL MOTOR	√	√	R-PET08/13-CTR
CUERPO DE BOMBA	√	√	R-PET08/13-CB
DIFUSOR	√	√	R-PET08/13-DIFU
IMPULSOR	√		R-PET08-IMP
		√	R-PET13-IMP
JUEGO DE 4 TIRANTES	√		R-PET08-JTIR
		√	R-PET13-JTIR
O-RING DE CUERPO	√	√	R-PET08/13-OC
ORING DE DIFUSOR	√	√	R-PET08/13-ODIFU
ORING DE VENTURY	√	√	R-PET08/13-OVENT
SELLO MECÁNICO PET08 Y PET13	√	√	R-PET08/13-SM
PIE DE BOMBA	√	√	R-PET08/13-PIE
PLATO PORTA SELLO	√	√	R-PET08/13-PPSELLO
RETEN	√	√	R-PET08/13-RETEN
SWITCH ON/OFF PET08 Y PET13	√	√	R-PET08/13-SW
TAPA DE CAJA DE CONEXIONES PET08 Y PET13	√	√	R-PET08/13-TCCO
TAPA DE VENTILADOR PET08 Y PET13	√	√	R-PET08/13-TVENT
TAPÓN DE CEBADO PET08 Y PET13	√	√	R-PET08/13-TCEB
TAPÓN DE DESAGÜE PET08 Y PET13	√	√	R-PET08/13-TDES
VENTILADOR PARA BOMBA PET08 Y PET13	√	√	R-PET08/13-VENT
VENTURY PET08	√		R-PET08-VENTURY
VENTURY PET13		√	R-PET13-VENTURY

REFACCIONES PRESURIZADORES MINISMART

REFACCIÓN	MINI60- 12/1127	MINI25- 10/1115	CÓDIGO
CABLE CONECTOR	√		R-MINI60/CABLE
CAJA CONEXIONES	√		R-MINI60/CAJACONEX
CAJA CONEX. Y CAP. 12UF		√	R-MINI/CAJACONEX
CAPACITOR 18UF	√		R-MINI60/CAPACITOR
CONECTOR ROSCADOS	√		R-MINI60/CONECTUB
		√	MINI/CONECTOR
SWITCH DE FLUJO	√		R-MINI60/SWFLUJO
		√	R-MINI25-SENFLU

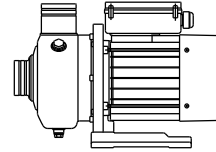



AQUA PAK® REFACCIONES
BOMBAS ALY

REFACCIÓN	ALY05/1230	ALY15/1230	ALY20/1230	ALY30/1230	ALY40/3230	CÓDIGO
TAPA PORTA		√	√	√	√	R-ALY05/TAPABOM
SELLO	√					R-ALY/TAPABOM
O-RING CUERPO BOMBA	√					R-ALY05/O-RINGCB
ALY O-RING CUERPO BOMBA		√	√	√	√	R-ALY/O-RINGCB
BALERO DELANTERO 6204		√	√			R-ALY15-20/BALDEL
BALERO TRASERO 6203		√	√			R-ALY15-20/BALTRA
BALERO DELANTERO 6205				√		R-ALY30-40/BALDEL
BALERO TRASERO 6205	√			√	√	R-ALY30-40/BALTRA
CUÑA DE FLECHA		√	√	√	√	R-ALY/CUÑA
SOPORTE BOMBA		√	√			R-ALY15/20/SOPBOM
MOTOR				√	√	R-ALY30/40/SOPBOM
SOP. BOMBA-MOTOR / PIE DE BOM	√					R-ALY05/SOPORTEBM
PIE DE BOMBA		√	√	√	√	R-ALY/PIEBOMBA
CAJA DE CONEXIONES	√					R-ALY05/CAJACONEX
		√	√			R-ALY15-20/CACONEX
				√	√	R-ALY30-40/CACONEX
TAPÓN DE PURGA	√	√	√	√	√	R-ALY/TAPPURGA
TAPÓN DREN. (ALY05 TAP. DE CEB.)	√	√	√	√	√	R-ALY/TAPDREN
TUERCA DE IMPULSOR	√	√	√	√	√	R-ALY/TUEIMP
CAPACITOR 10MF	√					R-ALY05/CAPACITOR
CAPACITOR 40MF		√	√			R-ALY20/CAPACITOR
CAPACITOR 25MF				√		R-ALY30/CAPACITOR
CUERPO DE BOMBA	√					R-ALY05/CUERPOBOM
		√	√			R-ALY15-20/CUERPBO
				√	√	R-ALY30-40/CUERPBO
IMPULSOR	√					R-ALY05/IMPULSOR
		√				R-ALY15/IMPULSOR
			√			R-ALY20/IMPULSOR
				√		R-ALY30/IMPULSOR
						R-ALY40/IMPULSOR
SELLO MECÁNICO	√					R-ALY05/SELLOMEC
		√	√	√	√	R-ALY/SELLOMEC
RETÉN BASE DE BOMBA	√	√				R-ALY05/RETEN
		√	√			R-ALY15-20/RETEN
				√	√	R-ALY30-40/RETEN
VENTILADOR	√					R-ALY05/VENT
		√	√			R-ALY15-20/VENT
				√	√	R-ALY30-40/VENT
CANDADO VENTILADOR		√	√			R-ALY15-20/CVENT
		√	√		√	R-ALY30-40/CVENT
			√			R-ALY15-20/CVENT-B
TAPA DE VENTILADOR	√					R-ALY05/TVENT
		√	√			R-ALY15-20/TVENT
				√	√	R-ALY30-40/TVENT
ARANDELA DE GOMA	√					R-ALY05/ARANDGOMA
		√	√			R-ALY15-20/ARNGOMA
				√	√	R-ALY30-40/ARNGOMA

AQUA PAK® REFACCIONES

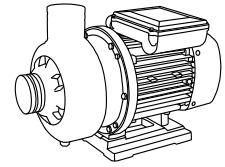
BOMBAS ALTRA



REFACCIÓN	ALTRA03/1230	ALTRA05/1230	ALTRA07/1230	ALTRA10/1230	ALTRA15/1230	ALTRA20/1230	ALTRA20/323	ALTRA30/1230	ALTRA30/3234	ALTRA40/3234	CÓDIGO
IMPULSOR	√										R-ALTRA03IMP
		√									R-ALTRA05IMP
			√								R-ALTRA07IMP
				√							R-ALTRA10IMP
					√						R-ALTRA15IMP
						√	√				R-ALTRA20IMP
								√	√		R-ALTRA30IMP
										√	R-ALTRA40IMP
SELLO MECÁNICO	√	√									R-ALTRA-SELLO1
			√	√							R-ALTRA-SELLO2
					√	√	√	√	√	√	R-ALTRA-SELLO3
CUERPO DE BOMBA	√	√									R-ALTRA-CUEBOMBA1
			√	√							R-ALTRA-CUEBOMBA2
					√	√	√	√	√	√	R-ALTRA-CUEBOMBA3
PLATO PORTA SELLO	√	√									R-ALTRA-PLASELLO1
			√	√							R-ALTRA-PLASELLO2
					√	√	√	√	√	√	R-ALTRA-PLASELLO3
PLATO P/BALERO Y PIE	√	√									R-ALTRA-PBALPIE
			√	√							R-ALTRA-PBALPIE2
PLATO P/BALERO					√	√	√	√	√	√	R-ALTRA-PBALERO
PIE BOMBA					√	√	√	√	√	√	R-ALY/PIEBOMBA
VENTILADOR	√	√									R-ALY05/VENT
			√	√							R-ALTRA-VENT1
					√	√	√	√	√	√	R-ALTRA-TVENT1
BALERO 62017	√	√									R-ALTRA-BALERO
BALERO 6202Z			√	√							R-ALTRA-BALERO2
PORTABALERO					√	√	√	√	√	√	R-ALTRA-PBALERO2

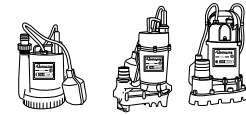

REFACCIÓN	SIGMA54A	SIGMA110A	SIGMA155AX	SIGMA160A	SIGMA 250A	SIGMA 350A	CÓDIGO
ADAPTADOR DESCARGA	√						R-SIGMA54A/ADAP
		√					R-SIGMA110A/ADAP
			√				R-SIGMA155AX/ADAP
				√			R-SIGMA160A/ADAP
ASA			√			R-SIGMA155AX/ASA	
BALERO	√	√					R-SIGMA110A/BALI
	√	√					R-SIGMA110A/BALS
			√				R-SIGMA155AX/BAL
				√			R-SIGMA160A/BALI
					√	√	R-SIG250-350/BINF
					√	√	R-SIG250-350/BSUP
CABLE CONECTOR	√	√					R-SIGMA54A/CABLE
			√				R-SIGMA155AX/CAB
				√			R-SIGMA160A/CAB
					√	√	R-SIG250-350/CAB
CAPACITOR	√						R-SIGMA54A/CAPAC
		√					R-SIGMA110A/CAPA
			√				R-SIGMA155AX/CAP
				√			R-SIGMA160A/CAPA
					√		R-SIGMA250A/CAPA
						√	R-SIGMA350A/CAPA
CARCASA			√				R-SIGMA155AX/BAS
			√				R-SIGMA155AX/TBA
					√		R-SIGMA250A/CAR
						√	R-SIGMA350A/CAR
COLADOR	√	√				R-SIGM54-110A/COL	
CUBIERTA			√				R-SIGMA155AX/TAP
					√	√	R-SIG250-350/TAP
EMPAQUE	√	√					R-SIGMA54A/EMPM
					√	√	R-SIG250-350/EMP
FLOTADOR	√	√			√	√	R-SIGMA54A/FLOT
			√	√			R-SIGMA160A/FLOT
IMPULSOR	√						R-SIGMA54A/IMP
		√					R-SIGMA110A/IMP
			√				R-SIGMA155AX/IMP
				√			R-SIGMA160A/IMP
					√		R-SIGMA250A/IMP
						√	R-SIGMA350A/IMP
JUNTA TORICA			√				R-SIGMA155AX/JUNT
				√			R-SIGMA160A/JUNT
					√	√	R-SIG250-350/JUNT
RETEN				√		R-SIGMA160A/RET	
SELLO MECÁNICO	√	√					R-SIGMA110A/SEL
			√				R-SIGMA155AX/SEL
				√			R-SIGMA160A/SMEC
					√	√	R-SIG350-350/SELM

REFACCIÓN	DRN-X-03-1127-A	CÓDIGO
BALERO INFERIOR Y BALERO SUPERIOR	√	R-DRN-X-03-KBSBI
PLATILLO PORTASELLO Y O-RING	√	R-DRN-X03-PPS
CAPACITOR	√	R-DRN-X03-CP
IMPULSOR, ARANDELA Y TUERCA	√	R-DRN-X03-IMP
CABLE DE ALIMENTACIÓN	√	R-DRN-X03-CA
FLOTADOR	√	R-DRN-X03-F
CUBIERTA DE MOTOR	√	R-DRN-X03-CM
PLATILLO PORTA BALERO Y O-RING	√	R-DRN-X03-PPB
ASIENTO DE SUCCIÓN	√	R-DRN-X03-AS
CAMISA	√	R-DRN-X03-CMA
REJILLA DE SUCCIÓN	√	R-DRN-X03-RS
ACC. DE BASE DE SUCCIÓN MÍNIMA	√	R-DRN-X03-ABSM
SELLO MECÁNICO	√	R-DRN-X03-SM

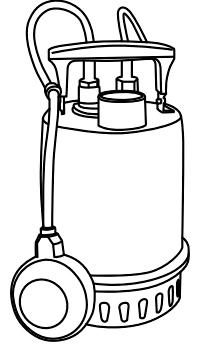
REFACCIONES BOMBA LOOPD y LOOP 3V

REFACCIÓN	LOOPD-65-8/1127	LOOPD-180-9/1127	LOOP3V 32-9/1115	CÓDIGO
CAJA DE CONEXIONES	√			LOOPD-65-CC
		√		LOOPD-180-CC
CAPACITOR	√			LOOPD-65-CAP12MF
		√		LOOPD-180-CAP18MF
BRIDAS	√		√	LOOP/KIT-BRIDA
		√		LOOPD180/KIT-BRIDA

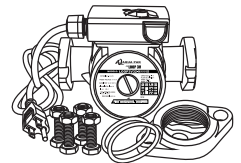

REFACCIÓN	BATTY38-12A	CÓDIGO
ADAPTADOR MANGUERA	√	R-BATTY38-AM
ANILLO ADAPTADOR MANGUERA	√	R-BATTY38-ALM
ASA AGARRE	√	R-BATTY38-ASA
MANGA CABLE ALIMENTACIÓN Y FLOT	√	R-BATTY38-MCAYF
CAMISA	√	R-BATTY38-CSA
O-RING CAMISA	√	R-BATTY38-OC
BALERO	√	R-BATTY38-BAL
EMPAQUE PARA SELLADO HIDRÁULICO	√	R-BATTY38-EMP
RETEN	√	R-BATTY38-RT
IMPULSOR	√	R-BATTY38-IMP
BASE SUCCIÓN	√	R-BATTY38-BS
REJILLA DE SUCCIÓN	√	R-BATTY38-RS
CANDADO ROTOR	√	R-BATTY38-CNR
FLOTADOR	√	R-BATTY38-F
ESCOBILLA PARA CONDUCCIÓN	√	R-BATTY38-EC
CABLE CONECTOR INTERNO	√	R-BATTY38-CCI
CABLE ALIMENTACIÓN 5M C/ PINZAS	√	R-BATTY38-CA
ARANDELA SUP	√	R-BATTY38-AS
PRENSACABLE ALIM Y FLOT	√	R-BATTY38-PC

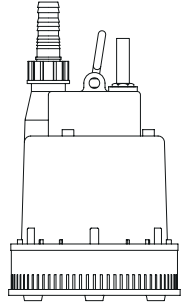

REFACCIÓN	ROBUSTA2/10/1127A	ROBUSTA2/10/1230A	ROBUSTA2.5/20/1230A	ROBUSTA2.5/20/3230	ROBUSTA2.5/30/3230	ROBUSTA2.5/40/3230	ROBUSTA2.5/50/3230	ROBUSTA2.5/50/3460	ROBUSTA2/75/3230	ROBUSTA2/75/3460	ROBUSTA3/30/3230	ROBUSTA3/40/3230	ROBUSTA4/50/3230	ROBUSTA4/50/3460	ROBUSTA4/100/3230	ROBUSTA4/100/3460	CÓDIGO
	CONECTOR MANGUERA	√	√	√	√	√	√	√	√	√	√	√	√	√	√	√	
																	R-ROB2.5/20-ADAP
																	R-ROB2.5-CONM
																	R-ROB3-BRIDA
																	R-ROB2.5-CONM
																	R-ROB3-BRIDA
																	R-ROB2.5-CONM
																	R-ROB4-CONM
																	R-ROB2/75-CONM
																	R-ROB4-BRIDA
ASA	√	√															R-ROB2/10-ASA
																	R-ROB2.5/20-ASA
BASE PARA CONECTOR																	R-ROB2.5-3/30-BCON
																	R-ROB2.5-3/40-BCON
																	R-ROB2.5-4/50-BCON
																	R-ROB2/75-BCON
IMPULSOR	√	√															R-ROB2/10-IMP
																	R-ROB2.5/20-IMP
																	R-ROB2.5/30-IMP
																	R-ROB2.5/40-IMP
																	R-ROB2.5/50-IMP
																	R-ROB2/75-IMP
																	R-ROB3/30-IMP
																	R-ROB3/40-IMP
																	R-ROB4/50-IMP
																	R-ROB4/100-IMP
BALERO SUPERIOR	√	√															R-ROB2/10-BALSUP
BALERO INFERIOR	√	√															R-ROB2.5/20-BALSUP
																	R-ROB2/10-BALINF
BALERO																	R-ROB2.5/20-BALINF
																	R-ROB2.5-3/30-BAL
																	R-ROB2.5-3/40-BAL
BALERO 31A																	R-ROB2.5-4/50-B31A
																	R-ROB2/75-B31A
																	R-ROB4/100-B31A
BALERO 31B																	R-ROB2.5-4/50-B31B
																	R-ROB2/75-B31B
																	R-ROB4/100-B31B
CUERPO DE BOMBA																	R-ROB2/CBOMBA7.5HP
CAPACITOR 20UF		√															R-ROB2/10-CAP20UF
CAPACITOR 35UF			√														R-ROB2.5/20CAP35UF
CAPACITOR 40UF	√																R-ROB2/10-CAP40UF

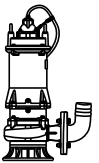

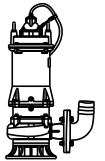

REFACCIÓN	ROBUSTA2/10/1127A	ROBUSTA2/10/1230A	ROBUSTA2.5/20/1230A	ROBUSTA2.5/20/3230	ROBUSTA2.5/30/3230	ROBUSTA2.5/40/3230	ROBUSTA2.5/40/3460	ROBUSTA2.5/50/3230	ROBUSTA2.5/50/3460	ROBUSTA2/75/3230	ROBUSTA2/75/3460	ROBUSTA3/30/3230	ROBUSTA3/40/3230	ROBUSTA3/40/3460	ROBUSTA4/50/3230	ROBUSTA4/50/3460	ROBUSTA4/100/3230	ROBUSTA4/100/3460	CÓDIGO
CUERPO DE BOMBA	√	√																	R-ROB2/CBOMBA1HP
			√	√															R-ROB2.5/CBOMBA2HP
					√														R-ROB2.5/CBOMBA3HP
						√	√												R-ROB2.5/CBOMBA4HP
								√	√										R-ROB2.5/CBOMBA5HP
										√	√								R-ROB2/CBOMBA7.5HP
												√	√	√					R-ROB3/CBOMBA3HP
															√	√			R-ROB4/CBOMBA5HP
CUÑA			√	√															R-ROB2.5/20-CUNA
					√														R-ROB2.5-3/30-CUNA
						√	√												R-ROB2.5-3/40-CUNA
								√	√										R-ROB2.5-4/50-CUNA
										√	√								R-ROB2/75-CUNA
																	√	√	R-ROB4/100-CUNA
		√	√																R-ROB2/10-CUNA
									√	√									R-ROB2.5-4/50-D41D
DISTANCIADOR 41D																			R-ROB2/10-EMPQ36A
EMPAQUE 36A	√	√																	R-ROB2.5/20-EMP36A
			√	√															R-ROB2.5/20-EMP36A
						√	√							√	√				R-ROB2.5-3/40-E36A
								√	√										R-ROB2.5-4/50-E36A
										√	√								R-ROB2/75-E36A
																	√	√	R-ROB4/100-E36A
																			R-ROB2.5-3/30-EMPA
		√	√																R-ROB2/10-EMPQ36B
EMPAQUE 36B			√	√															R-ROB2.5/20-EMP36B
					√														R-ROB2.5-3/30-EMPB
						√	√												R-ROB2.5-3/40-E36B
								√	√										R-ROB2.5-4/50-E36B
										√	√								R-ROB2/75-E36B
																	√	√	R-ROB4/100-E36B
																			R-ROB2/10-EMPQ36C
		√	√																R-ROB2.5/20-EMP36C
EMPAQUE 36C			√	√															R-ROB2.5-3/30-EMPC
					√	√													R-ROB2.5-3/40-E36C
								√	√										R-ROB2.5-4/50-E36C
										√	√								R-ROB2/75-E36C
																	√	√	R-ROB4/100-E36C
		√	√																R-ROB2/10-EMPQ36D
				√	√														R-ROB2.5/20-EMP36D
					√														R-ROB2.5-3/30-EMPD
EMPAQUE 36D						√	√												R-ROB2.5-3/40-E36D
								√	√										R-ROB2.5-4/50-E36D
										√	√								R-ROB2/75-E36D
																	√	√	R-ROB4/100-E36D
		√	√																R-ROB2/10-EMPQ36E
				√	√														R-ROB2.5/20-EMP36E
					√														R-ROB2.5-3/30-EMPE
						√	√								√	√			R-ROB2.5-3/40-E36E
EMPAQUE 36E								√	√										R-ROB2.5-4/50-E36E
										√	√								R-ROB2/75-E36E
																	√	√	R-ROB4/100-E36E
		√	√																R-ROB2/10-EMPA48B
				√	√														R-ROB2.5/20-EMP48B
					√														R-ROB2.5-3/30-EMBR
						√	√												R-ROB2.5-3/40-EMPB
	EMPAQUE BRIDA										√	√							
															√	√			R-ROB2/75-EMPB
																	√	√	R-ROB4/100-EMPB



AQUA PAK® REFACCIONES BOMBAS ROBUSTA

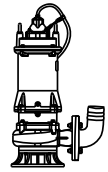

REFACCIÓN	ROBUSTA2/10/1127A	ROBUSTA2/10/1230A	ROBUSTA2.5/20/1230A	ROBUSTA2.5/20/3230	ROBUSTA2.5/30/3230	ROBUSTA2.5/40/3230	ROBUSTA2.5/40/3460	ROBUSTA2.5/50/3230	ROBUSTA2.5/50/3460	ROBUSTA2/75/3230	ROBUSTA2/75/3460	ROBUSTA3/30/3230	ROBUSTA3/40/3230	ROBUSTA3/40/3460	ROBUSTA4/50/3230	ROBUSTA4/50/3460	ROBUSTA4/100/3230	ROBUSTA4/100/3460	CÓDIGO
FLOTADOR ROBUSTA	√	√	√																R-ROB2.5/20-FLOTAD
IMPULSOR	√	√																	R-ROB2/10-IMP
			√	√															R-ROB2.5/20-IMP
					√														R-ROB2.5/30-IMP
						√	√												R-ROB2.5/40-IMP
								√	√										R-ROB2.5/50-IMP
										√	√								R-ROB2/75-IMP
												√							R-ROB3/30-IMP
													√	√					R-ROB3/40-IMP
															√	√			R-ROB4/50-IMP
JUNTA TORICA	√	√																	R-ROB2/10-JTORICA
																			R-ROB2.5/20-JTORIC
PIE DE BOMBA			√	√															R-ROB2.5/PBOMBA2HP
					√														R-ROB2.5/PBOMBA3HP
						√	√												R-ROB2.5/PBOMBA4HP
								√	√										R-ROB2.5/PBOMBA5HP
										√	√								R-ROB2/PBOMBA7.5HP
RELE	√	√																	R-ROB2/10-RELE
			√																R-ROB2/10-RELE2
				√															R-ROB2.5/20-RELE1
					√														R-ROB2.5/20-RELE2
						√	√					√		√					R-ROB2.5-3/30-RELE
RETÉN	√	√																	R-ROB2.5-3/40-RELE
			√	√															R-ROB2/10-RETEN
					√							√							R-ROB2.5/20-RETEN
						√	√						√	√					R-ROB2.5-3/30-RET
								√	√						√	√			R-ROB2.5-3/40-RETE
										√	√								R-ROB2.5-4/50-RETE
SELLO MECÁNICO	√	√																	R-ROB2/75-RETE
			√	√															R-ROB2/10-SELLOM
					√							√							R-ROB2.5/20-SELLOM
						√	√						√	√					R-ROB2.5-3/30-SM
								√	√						√	√			R-ROB2.5-3/40-SM
										√	√								R-ROB2.5-4/50-SM
SELLO MECÁNICO 34A																√	√	R-ROB4/100-SM34A	
SELLO MECÁNICO 34B																√	√	R-ROB4/100-SM34B	
TORNILLO 42B	√	√																	R-ROB2/10-TORN42B
TORNILLO 42D			√	√															R-ROB2.5/20-TOR42B
TORNILLO 42E								√	√										R-ROB2/75-T42D
TORNILLOS 42B					√							√							R-ROB2.5-4/50-T42E
TORNILLOS 42F						√	√						√	√					R-ROB2.5-3/30-TORG
TUERCA 43B	√	√																	R-ROB2.5-3/40-T42F
			√	√															R-ROB2/10-TUER43
					√														R-ROB2.5/20-TUER43
						√	√					√	√						R-ROB2.5-3/30-TUEB
						√	√					√	√					R-ROB2.5-3/40-T43B	



REFACCIONES BOMBAS ROBUSTA

REFACCIÓN	ROBUSTA6/ 100/3460	ROBUSTA6/ 100/3230	ROBUSTA4/ 150/3460	ROBUSTA4/ 150/3230	ROBUSTA6/ 150/3460	ROBUSTA6/ 150/3230	CÓDIGO
BALERO	√	√	√	√	√	√	R-COBA4/100-BSUP
	√	√	√	√	√	√	R-COBA4/100-BINF
CABLE DE ALIMENTACIÓN	√						R-ROB-CCON-20242
		√					R-ROB-CCON-20245
			√		√		R-COB-CCON-20233
				√		√	R-COB-CCON-10083A
DESCARGA	√	√			√	√	CODOB6"-6"
			√	√			CODOB4"-4"
EMPAQUE DE DESCARGA	√	√			√	√	R-ROB6-EMPB
			√				R-ROB4/100-EMPB
IMPULSOR	√	√					R-ROB6-100-IMP
			√	√			R-ROB4-150-IMP
					√	√	R-ROB6-150-IMP
ORING	√	√	√	√	√	√	R-ROB4/100-E36C
	√	√	√	√	√	√	R-ROB4/100-E36A
	√	√	√	√	√	√	R-ROB4/100-E36B
	√	√	√	√	√	√	R-ROB4/100-E36E
	√	√	√	√	√	√	R-ROB4/100-E36D
PLATO PORTA SELLO	√	√	√	√	√	√	R-ROB4/100-SM34B
PROTECTOR TÉRMICO	√						R-ROB6-100-RELE
SELLO MECÁNICO	√	√	√	√	√	√	R-ROB4/100-SM34A

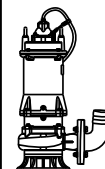

REFACCIONES BOMBAS VOID

REFACCIÓN	VOID-GX-10 1127A	VOID-GX-10 1230A	CÓDIGO
BALERO INFERIOR	√	√	R-VOID-BALERO-INF
BALERO SUPERIOR	√	√	R-VOID-BALERO-SUP
CABLE ALIMENTACIÓN	√	√	R-VOID-CABLE
CAPACITOR	√		R-VOID-CAPACITOR1
		√	R-VOID-CAPACITOR2
CONJUNTO DE CORTE	√	√	R-VOID-KIT-CORTE
FLOTADOR	√	√	R-VOID-FLOTADOR
IMPULSOR	√	√	R-VOID-IMPULSOR
ORING	√	√	R-TIDE2-ORING36A
	√	√	R-TIDE2-ORING36C
	√	√	R-COBA6810-OR36F
	√	√	R-TANT4-6-ORING36C
RETEN	√	√	R-VOID-S.ACEITE
SELLO MECÁNICO	√	√	R-ROB2/10-SELLOM



REFACCIÓN	M0.3X	M0.5X	M0.7X	M1X	M1.5X	M2X	CÓDIGO
ANILLO DE PARO	√	√	√	√	√	√	R-M0.3-2X/ANIPARO
ANILLO DE RETENCIÓN	√	√	√	√	√	√	R-MAX/ANILLORET
ARANDELA	√	√	√	√	√	√	R-M0.3-2X/ARAN90
	√	√	√	√	√	√	R-M0.3-2X/ARAN91
BUJE INTERMEDIO	√	√	√	√	√	√	R-M0.3-2X/BUJINT
BUJE DISTANCIADOR	√	√	√	√	√	√	R-M0.3-2X/BUDIS42
	√	√	√	√	√	√	R-M0.3-2X/BUDIS42A
CANDADO	√	√	√	√	√	√	R-M0.3-5X/CANDADO
COJINETE ARAÑA SUPERIOR	√	√	√	√	√	√	R-M0.3-2X/COARASU
COLADOR	√	√	√	√	√	√	R-M0.3-5X/COLADOR
DESCARGA	√	√	√	√	√		R-MAX/DESCAR1.25"
						√	R-MAX/DESCAR1.5"
DIFUSOR	√						R-M0.3X/DIFUSOR
		√					R-M0.5X/DIFUSOR
			√	√			R-M0.7-1X/DIFUSOR
					√	√	R-M1.5-2X/DIFUSOR
IMPULSOR	√						R-M0.3X/IMPULSOR
		√					R-M0.5X/IMPULSOR
			√				R-M0.7X/IMPULSOR
				√			R-M1X/IMPULSOR
					√		R-M1.5X/IMPULSOR
						√	R-M2X/IMPULSOR
O-RING	√	√	√	√	√	√	R-M0.3-2X/O-RING86
	√	√	√	√	√	√	R-MAX/O-RING87
SUCCIÓN	√	√	√	√	√	√	R-M0.3-5X/SUCCION
TAZÓN	√						R-M0.3X/TAZON
		√					R-M0.5X/TAZON
			√				R-M0.7X/TAZON
				√			R-M1X/TAZON
					√		R-M1.5X/TAZON
						√	R-M2X/TAZON
TORNILLO 88	√	√	√	√	√	√	R-M0.3-2X/TORN88
TORNILLO CAMISA	√	√	√	√	√	√	R-MAX/TORNCAMISA
VÁLVULA CHECK	√	√	√	√	√	√	R-M0.3-2X/VALVCK



REFACCIÓN	M2.5X	M3X	M3.5X	M4X	M5X	CÓDIGO
ANILLO DE PARO	√	√	√	√	√	R-M2.5-5X/ANIPARO
ANILLO DE RETENCIÓN	√	√	√	√	√	R-MAX/ANILLORET
ANILLO DE RETENCIÓN INFERIOR	√	√	√	√	√	R-MAX/ANIRETINF
ARANDELA	√	√	√	√	√	R-M2.5-5X/ARAN92
	√	√	√	√	√	R-M2.5-5X/ARAN89
BUJE INTERMEDIO	√	√	√	√	√	R-M2.5-5X/BUJINT
BUJE DISTANCIADOR	√	√	√	√	√	R-M2.5-5X/BUDIS42
			√	√		R-M3.5-4X/BUDIS42B
					√	R-M5X/BUDIS42B
CANDADO	√	√	√	√	√	R-M0.3-5X/CANDADO
COJINETE ARAÑA	√	√	√	√	√	R-MAX/COJARAÑA
COLADOR	√	√	√	√	√	R-M0.3-5X/COLADOR
DESCARGA	√					R-MAX/DESCAR2"
		√	√	√	√	R-MAX/DESCAR2"A
DIFUSOR	√	√				R-M2.5-3X/DIFUSOR
			√			R-M3.5X/DIFUSOR
				√		R-M4X/DIFUSOR
					√	R-M5X-DIFUSOR
DISTANCIADOR			√			R-M3.5X/DISTPLAST
IMPULSOR	√					R-M2.5X/IMPULSOR
		√				R-M3X/IMPULSOR
			√			R-M3.5X/IMPULSOR
				√		R-M4X/IMPULSOR
					√	R-M5X/IMPULSOR
O-RING	√	√	√	√	√	R-M2.5-5X/O-RING86
	√	√	√	√	√	R-MAX/O-RING87
SUCCIÓN	√	√	√	√	√	R-M0.3-5X/SUCCION
	√					R-M2.5X/TAZON
TAZÓN		√				R-M3X/TAZON
			√			R-M3.5X/TAZON
				√		R-M4X/TAZON
					√	R-M5X/TAZON
TORNILLO CAMISA	√	√	√	√	√	R-MAX/TORNCAMISA
VÁLVULA CHECK	√	√	√	√	√	R-M2.5-5X/VALVCK



REFACCIÓN	KANKIPLUS 44A-1127	KANKIPLUS 64A-1127	CÓDIGO
ASA	√	√	R-KP-ASA
KIT CABLE CONECTOR/FLOTADOR Y CUBIERTA SUPERIOR	√		R-KP-CC-F-CS-44A
		√	R-KP-CC-F-CS-64A
CAPACITOR	√	√	R-KP-CAPACITOR
ANILLO DE PROTECCIÓN	√	√	R-KP-APROTECTOR
O-RING A	√	√	R-KP-ORING-A
BRIDA SUPERIOR ESTATOR	√	√	R-KP-BR-SUP-EST
O-RING B	√	√	R-KP-ORING-B
O-RING C	√	√	R-KP-ORING-C
ARANDELA ONDULADA BAL. SUP.	√	√	R-KP-ARANDELA-OND
BALERO SUPERIOR 6201-2RS	√	√	R-KP-BAL-SUP
BALERO INFERIOR 6202-2RS	√	√	R-KP-BAL-INF
O-RING D	√	√	R-KP-ORING-D
BRIDA INFERIOR ESTATOR	√	√	R-KP-BR-INF-EST
CAMISA KANKI PLUS 44A	√		R-KP-CAMISA-44A
CAMISA KANKI PLUS 64A		√	R-KP-CAMISA-64A
SECCIÓN CAMISA	√	√	R-KP-SECC-CAMISA
TORN. HEXAG. SECC. CAMISA A BRIDA SUP. KP 44A	√		R-KP-TOR-HEX44A
TORN. HEXAG. SECC. CAMISA A BRIDA SUP. KP 64A		√	R-KP-TOR-HEX64A
ARANDELA TORN. HEXAG. SECC. CAMISA A BRIDA SUP.	√	√	R-KP-ARANDELA-TOR
O-RING E	√	√	R-KP-ORING-E
TORNILLO DE DRENADO ACEITE ESTATOR	√	√	R-KP-TOR-DREN
LUBRICADOR SELLO MECÁNICO	√	√	R-KP-LUB-SELLMEC
DOBLE SELLO MECÁNICO	√	√	R-KP-SELLMEC
TORNILLOS SECCIÓN CAMISA	√	√	R-KP-TOR-SECC-CAM
ARANDELA POSICIÓN #22	√	√	R-KP-ARANDELA-22
ARANDELA POSICIÓN #23	√	√	R-KP-ARANDELA-23
DIFUSOR	√	√	R-KP-DIFUSOR
IMPULSOR	√	√	R-KP-IMPULSOR
TAPA DIFUSOR	√	√	R-KP-TAPADIF
ARANDELA POSICIÓN #27	√	√	R-KP-ARANDELA-27
ARANDELA POSICIÓN #28	√	√	R-KP-ARANDELA-28
TUERCA SUJECIÓN FLECHA	√	√	R-KP-TUERCA-SUJ
BASE SUCCIÓN KP 44A	√		R-KP-BASE-SUCC-44A
BASE SUCCIÓN KP 64A		√	R-KP-BASE-SUCC-64A
ARANDELA POSICIÓN #31	√	√	R-KP-ARANDELA-31
TORNILLOS HEXAGONALES BASE SUCCIÓN 44A	√		R-KP-TORHEX-BS-44A
TORNILLOS HEXAGONALES BASE SUCCIÓN 64A		√	R-KP-TORHEX-BS-64A

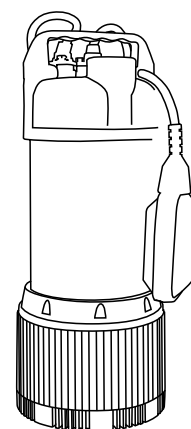

REFACCIÓN	KANKI10A-3	KANKI13A-4	CÓDIGO
CABLE CONECTOR	√	√	RN-KA-CABLE CONECT
ASA DE AGARRE	√	√	RN-KA-ASA
CUBIERTA SUPERIOR	√	√	RN-KA-CUBIERTA SUP
CAMISA DE BOMBA	√		RN-KA10-CAMISA
		√	RN-KA13-CAMISA
O-RING DESCARGA	√	√	RN-KA-ORING DESC
CARCASA DE BOMBA	√	√	RN-KA-CARCASA
EMP. CABLE FLOT/ALIM	√	√	RN-KA10-EMPA.CABL
PRENSA CABLE	√	√	RN-KA-PRENSA CABL
CAPACITOR 35 mF	√	√	R-KA CAPACITOR
BASE CAPACITOR	√	√	RN-KA-BASE CAPACIT
CUBIERTA MOTOR	√	√	R-KA-CUBIERT.MOT
O-RING MOTOR	√	√	RN-KA-ORING MOTOR
SELLO MECÁNICO	√		RN-KA10-SELLO MEC
ANILLO MOTOR	√	√	RN-KA-ANILLO.MOT
O-RING CUERPO DE BOMBA	√		RN-KA-ORIN.CUE.BO
		√	RN-KA13-CUERP.BOMB
O-RING BASE	√	√	RN-KA-ORING BASE
IMPULSOR	√	√	R-KA-IMPULSOR
DIFUSOR	√	√	RN-KA-DIFUSOR
TAPA DIFUSOR	√	√	RN-KA-TAPA DIFUS
BASE	√	√	RN-KA-BASE
O-RING IMPULSOR	√	√	RN-KA-ORINGIMP

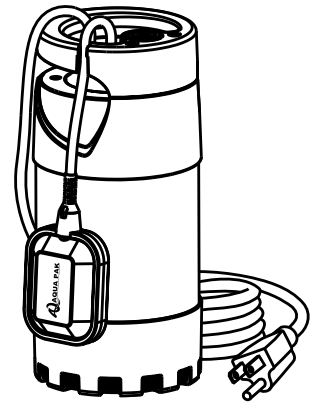



REFACCIONES
MOTORES SUMERGIBLES DE 4"

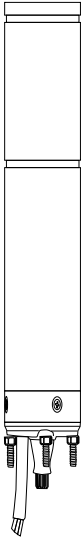

REFACCIÓN	HP	Fases x volts										CÓDIGO						
		1/2	1/2	1/2	3/4	3/4	1x115	1x230	3x230	1x230	3x230		1x230	3x230	1x230	3x230	1x230	3x230
RODAMIENTO SUPERIOR		✓	✓	✓	✓	✓	✓	✓	✓	✓	✓	✓	✓	✓	✓	✓	✓	007-001-D-001
RODAMIENTO INFERIOR		✓	✓	✓	✓	✓	✓	✓	✓	✓	✓	✓	✓	✓	✓	✓	✓	007-001-D-002
RODAMIENTO SUPERIOR												✓	✓					007-001-D-003
RODAMIENTO INFERIOR												✓	✓					007-001-D-004
RODAMIENTO SUPERIOR																✓	✓	007-001-D-005
RODAMIENTO INFERIOR																✓	✓	007-001-D-006
CANDADO INFERIOR		✓	✓	✓	✓	✓	✓	✓	✓	✓	✓	✓	✓	✓	✓	✓	✓	007-001-D-024
ARANDELA ONDULADA		✓	✓	✓	✓	✓	✓	✓	✓	✓	✓	✓	✓	✓	✓	✓	✓	007-001-D-025
CUBIERTA INFERIOR		✓	✓	✓	✓	✓	✓	✓	✓	✓	✓	✓	✓	✓	✓	✓	✓	007-001-D-027
O-RING SOPORTE SUPERIOR		✓	✓	✓	✓	✓	✓	✓	✓	✓	✓	✓	✓	✓	✓	✓	✓	
SELLO MECÁNICO		✓	✓	✓	✓	✓	✓	✓	✓	✓	✓	✓	✓	✓	✓	✓	✓	
CUBIERTA DE SELLO		✓	✓	✓	✓	✓	✓	✓	✓	✓	✓	✓	✓	✓	✓	✓	✓	
CUBIERTA P/ARENA		✓	✓	✓	✓	✓	✓	✓	✓	✓	✓	✓	✓	✓	✓	✓	✓	007-001-D-048
ARANDELA DESARENADOR		✓	✓	✓	✓	✓	✓	✓	✓	✓	✓	✓	✓	✓	✓	✓	✓	
DESARENADOR CENTRÍFUGO		✓	✓	✓	✓	✓	✓	✓	✓	✓	✓	✓	✓	✓	✓	✓	✓	
CUBIERTA SUPERIOR		✓	✓	✓	✓	✓	✓	✓	✓	✓	✓	✓	✓	✓	✓	✓	✓	
TUERCA PARA MOTOR AQUAPAK		✓	✓	✓	✓	✓	✓	✓	✓	✓	✓	✓	✓	✓	✓	✓	✓	007-001-D-050
ARANDELA DE PRESIÓN		✓	✓	✓	✓	✓	✓	✓	✓	✓	✓	✓	✓	✓	✓	✓	✓	007-001-D-054
BIRLO A		✓	✓	✓	✓	✓	✓	✓	✓	✓	✓	✓	✓	✓	✓	✓	✓	007-001-D-052
BIRLO B		✓	✓	✓	✓	✓	✓	✓	✓	✓	✓	✓	✓	✓	✓	✓	✓	007-001-D-053
CABLE CONECTOR 1/2-2 HP		✓	✓	✓	✓	✓	✓	✓	✓	✓	✓	✓	✓	✓	✓	✓	✓	007-001-D-046
CABLE CONECTOR 3-5 HP																		007-001-D-103
CABLE CONECTOR 5HP 1F-7.5-10 HP																✓	✓	007-001-D-047



REFACCIONES CAJAS DE CONTROL AQUA PAK

REFACCIÓN	CCQA 1/2115	CCQA 1/2230	CCQA 3/4230	CCQA 1115	CCQA 1230	CCQA 1.5230	CCQA 2230	CCQA 3230	CCQA 5230	CÓDIGO
PROTECCION SOBRECARGA	√									007-001-D-084
		√								007-001-D-104
			√							007-001-D-105
				√						007-001-D-086
					√					007-001-D-106
						√				007-001-D-087
							√			007-001-D-088
								√		007-001-D-089
									√	007-001-D-090
CAPACITOR DE TRABAJO 65 mF	√									007-001-D-091
CAPACITOR DE TRABAJO 16 mF		√								007-001-D-092
CAPACITOR DE TRABAJO 20 mF			√							007-001-D-094
CAPACITOR DE TRABAJO 100 mF				√						007-001-D-095
CAPACITOR DE TRABAJO 25 mF					√					007-001-D-096
CAPACITOR DE TRABAJO 35 mF						√				007-001-D-098
CAPACITOR DE TRABAJO 40 mF							√			007-001-D-099
CAPACITOR DE TRABAJO 55 mF								√		007-001-D-100
CAPACITOR DE TRABAJO 75 mF									√	007-001-D-101
CAPACITOR DE ARRANQUE 125 mF						√				007-001-D-107
CAPACITOR DE ARRANQUE 200 mF							√			007-001-D-108
CAPACITOR DE ARRANQUE 300 mF								√		007-001-D-109
CAPACITOR DE ARRANQUE 400 mF									√	007-001-D-110
SWITCH ENCENDIDO/APAGADO	√	√	√	√	√	√	√		√	007-001-D-111
RELEVADOR PARA CAJA AQUAPAK						√	√	√	√	007-001-D-113

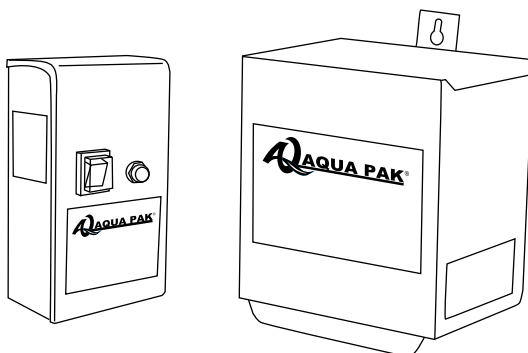

REFACCIÓN	MSW6 7.53230	MSW6 7.53460	MSW6 103230	MSW6 103460	MSW6 153230	MSW6 153460	MSW6 203230	MSW6 203460	MSW6 253230	MSW6 253460	MSW6 303230	MSW6 303460	MSW6 403230	MSW6 40460	MSW6 503230	MSW6 503460	CÓDIGO
ARANDELA DE BAJA CARGA	✓	✓	✓	✓	✓	✓	✓	✓	✓	✓	✓	✓	✓	✓	✓	✓	R-PBCARGA-MSW6"
CAJA AJUSTE MSW6"	✓	✓	✓	✓	✓	✓	✓	✓	✓	✓	✓	✓	✓	✓	✓	✓	R-CA-MSW6
CONJUNTO DE SEGMENTOS	✓	✓	✓	✓	✓	✓	✓	✓	✓	✓	✓	✓	✓	✓	✓	✓	R-CDSEG-MSW6"
CUBIERTA SUP. 7.5-50 W6" CORTA	✓	✓	✓	✓	✓	✓	✓	✓	✓	✓	✓	✓	✓	✓	✓	✓	R-CS-MSW6-C
CUBIERTA SUP. 7.5-50 W6" LARGA	✓	✓	✓	✓	✓	✓	✓	✓	✓	✓	✓	✓	✓	✓	✓	✓	R-CS-MSW6-L
TAPA SELLO MECÁNICO	✓	✓	✓	✓	✓	✓	✓	✓	✓	✓	✓	✓	✓	✓	✓	✓	R-TAPSM-MSW6"
DESARENADOR	✓	✓	✓	✓	✓	✓	✓	✓	✓	✓	✓	✓	✓	✓	✓	✓	R-DESARE-MSW6"
DIAFRAGMA	✓	✓	✓	✓	✓	✓	✓	✓	✓	✓	✓	✓	✓	✓	✓	✓	R-DIAF-MSW6"
DISCO DE GRAFITO	✓	✓	✓	✓	✓	✓	✓	✓	✓	✓	✓	✓	✓	✓	✓	✓	R-DISCOGR-MSW6"
SELLO CONECTOR	✓	✓	✓	✓	✓	✓	✓	✓	✓	✓	✓	✓	✓	✓	✓	✓	R-SECMSW7.5-20/230
	✓	✓	✓	✓	✓	✓	✓	✓	✓	✓	✓	✓	✓	✓	✓	✓	R-SECMSW7.5-30/460
	✓	✓	✓	✓	✓	✓	✓	✓	✓	✓	✓	✓	✓	✓	✓	✓	R-SECMSW25/230
	✓	✓	✓	✓	✓	✓	✓	✓	✓	✓	✓	✓	✓	✓	✓	✓	R-SECMSW30-50/230
SELLO MECÁNICO	✓	✓	✓	✓	✓	✓	✓	✓	✓	✓	✓	✓	✓	✓	✓	✓	R-SECMSW40-50/460
	✓	✓	✓	✓	✓	✓	✓	✓	✓	✓	✓	✓	✓	✓	✓	✓	R-SECMSWPT100
SOPORTE INFERIOR	✓	✓	✓	✓	✓	✓	✓	✓	✓	✓	✓	✓	✓	✓	✓	✓	R-SM-MSW6"
	✓	✓	✓	✓	✓	✓	✓	✓	✓	✓	✓	✓	✓	✓	✓	✓	R-SI-MSW6
SOPORTE SUPERIOR	✓	✓	✓	✓	✓	✓	✓	✓	✓	✓	✓	✓	✓	✓	✓	✓	R-SI2-MSW6
	✓	✓	✓	✓	✓	✓	✓	✓	✓	✓	✓	✓	✓	✓	✓	✓	R-SS-MSW6
TAPA DE DIAFRAGMA	✓	✓	✓	✓	✓	✓	✓	✓	✓	✓	✓	✓	✓	✓	✓	✓	R-TD-MSW6



AQUA PAK®

MOTOR AQUA PAK SERIE W DE 8", 10" Y 12"



REFACCIÓN	MSW8/6 603460	MSW8 753460	MSW8 1003460	MSW10/8 1253460	MSW10/8 1503460	MSW10/8 1753460	MSW10/8 2003460	MSW12/10 2503460	CÓDIGO
ADAPTADOR BRIDA	√								R-AB-MSW8/6-60
		√	√						R-AB-MSW8/6-75/100
				√	√	√	√		R-AB-MSW10/8
ARANDELA BAJA CARGA	√	√	√					√	R-AB-MSW12/10
				√	√	√	√		R-PBCARGA-MSW8"
CAJA AJUSTE	√	√	√						R-PBCARGA-MSW10/8"
				√	√	√	√		R-CA-MSW8
CONJUNTO DE SEGMENTOS	√	√	√					√	R-CA-MSW10
				√	√	√	√		R-CA-MSW12
								√	R-CDSEG-MSW8"
CUBIERTA DE DIAFRAGMA				√	√	√	√		R-CDSEG-MSW10/8"
								√	R-CDSEG-MSW12"
CUBIERTA SUPERIOR 60-100 W8"	√	√	√					√	R-CD-MSW12
				√	√	√	√		R-CS-MSW10
TAPA SELLO MECÁNICO	√	√	√						R-CS-MSW8
				√	√	√	√		R-TAPSM-MSW8"
DESARENADOR				√	√	√	√		R-TAPSM-MSW10/8"
								√	R-TAPSM-MSW12/10"
	√	√	√						R-DESARE-MSW8"
DIAFRAGMA				√	√	√	√		R-DESARE-MSW10/8"
								√	R-DESARE-MSW12/10"
	√	√	√						R-DIAF-MSW8"
DISCO DE GRAFITO				√	√	√	√		R-DIAF-MSW10/8"
								√	R-DIAF-MSW250
	√	√	√						R-DISCOGR-MSW8"
INTERCAMBIADOR DE CALOR				√	√	√	√		R-DISCOGR-MSW10/8"
								√	R-DISCOGR-MSW12"
SELLO CONECTOR								√	R-IC-MSW12
	√								R-SECMSW60/230-460
		√	√						R-SECMSW75-100/460
				√					R-SECMSW125/460
					√				R-SECMSW150/460
SELLO MECÁNICO						√			R-SECMSW175-200
								√	R-SECMSW250/460
	√	√	√						R-SM-MSW8"
SOPORTE INFERIOR				√	√	√	√		R-SM-MSW10/8"
								√	R-SM-MSW12/10"
SOPORTE SUPERIOR	√	√	√						R-SI-MSW8
				√	√	√	√		R-SI-MSW10
								√	R-SI-MSW12
TAPA DIAFRAGMA	√	√	√						R-SS-MSW8
				√	√	√	√		R-SS-MSW10
TAPA DIAFRAGMA								√	R-SS-MSW12
	√	√	√						R-TD-MSW8
				√	√	√	√		R-TD-MSW10
							√	R-TD-MSW12	



REFACCIONES MOTOBOMBA SUMERGIBLE PARA ACHIQUE

REFACCIÓN	MAGNUS-47AE	MAGNUS-150AE	CÓDIGO
ADAPTADOR DE MANGUERA	√		ADP-0204-001
BASE DE BOMBA		√	BSBM-04-001
	√		CBASE-04-001
CABLE DE ALIMENTACIÓN	√		CNCT-0103-0201-001
COLADOR	√		CLDOR-04-001
IMPULSOR		√	IMP-0102-0104-001
	√		IMP-0102-0104-002
SELLO		√	SM-0106-001
VOLUTA		√	VOLUTA-04-001

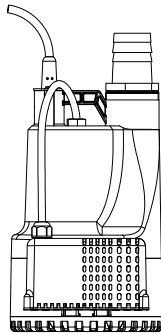

MAGNUS-47AE

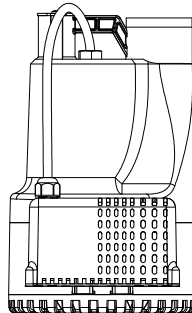

MAGNUS-150AE

REFACCIÓN	ELITX66A-1127	CÓDIGO
CABLE Y FLOTADOR	✓	R-ELITX66-CAB-FLOT
DESCARGA	✓	R-ELITX66-DESCARGA
CAPACITOR 25 mF	✓	R-ELITX66-CAP
CANDADO DE TORNILLO	✓	R-ELITX66-CAN-TORN
SELLO MECÁNICO	✓	R-ELITX66-SELLO
IMPULSOR	✓	R-ELITX66-IMPULSOR
TAPA DE DIFUSOR	✓	R-ELITX66-TAP-DIF
DIFUSOR	✓	R-ELITX66-DIFUSOR
BUJE INOXIDABLE	✓	R-ELITX66-BUJ-FLEC
BUJE DE CAUCHO	✓	R-ELITX66-BUJ-BASE
BASE	✓	R-ELITX66-BASE
BALERO 6202	✓	R-ELITX66-BAL-6202
BALERO 6203	✓	R-ELITX66-BAL-6203

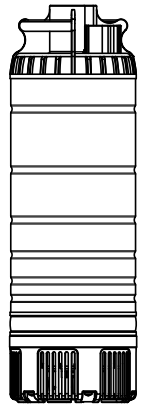

REFACCIÓN	KAN5.5	KAN8.5	KAN15	KAN15	CÓDIGO
KIT DE REPARACIÓN MENOR DE 5 PASOS PARA KAN5.5	√				R-KAN5-KREPM-5
KIT DE REPARACIÓN MENOR DE 5 PASOS PARA KAN8.5		√			R-KAN8-KREPM-5
KIT DE REPARACIÓN MENOR DE 5 PASOS PARA KAN15 Y KAN20			√	√	R-KAN20-KREPM-5
KIT DE REPARACIÓN ESTÁNDAR PARA KAN5.5	√				R-KAN5-KREP-STD
KIT DE REPARACIÓN ESTÁNDAR PARA KAN8.5		√			R-KAN8-KREP-STD
KIT DE REPARACIÓN ESTÁNDAR PARA KAN15			√		R-KAN15-KREP-STD
KIT DE REPARACIÓN ESTÁNDAR PARA KAN20				√	R-KAN20-KREP-STD
KIT DE TUERCA Y CONO DE 5 PASOS PARA KAN5.5	√				R-KAN5-KREP-TC5
KIT DE TUERCA Y CONO DE 5 PASOS PARA KAN8.5, KAN15 Y KAN20		√	√	√	R-KAN20-KREP-TC5

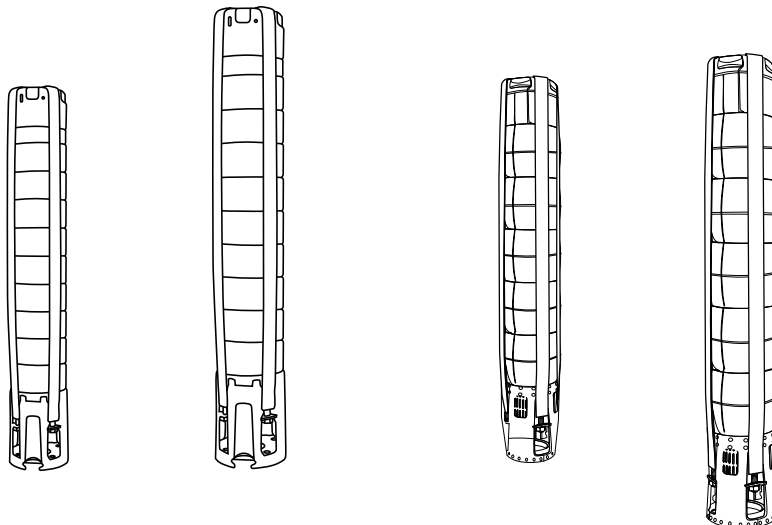

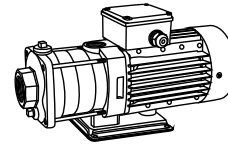

ALTAMIRA®

REFACCIONES

BOMBAS SCALA

REFACCIÓN	SCALA50-4 /1115	SCALA 50-5/1230	SCALA50-5/3234	SCALA 100-3/1230	SCALA 100-3/3234	SCALA 100-4/1230	SCALA 100-4/3234	SCALA 130-2-1/1230	SCALA 130-2-1/3234	SCALA 130-2/1230	SCALA 130-2/3234	SCALA 200-2-1/3234	SCALA200-2/3234	CÓDIGO
TAPA VENTILADOR	√	√	√	√	√	√	√	√						R-T/STVEN0.5-1.5HP
										√	√	√		R-T/STVENT2-3HP
													√	R-T/STVENT4HP
VENTILADOR MOTOR	√	√	√	√	√	√	√	√	√					R-T/SVENT0.5-1.5HP
										√	√	√	√	R-T/SVENT2-4HP
CAJA CONEXIONES			√		√		√		√			√	√	R-SC5/10/1321CC3F
												√	√	R-SC132/20/X15CC3F
	√	√		√		√		√						R-SC5/10/1321CC1F
BALERO TRASERO														R-SC132/X105CC1F
	√	√	√	√	√	√	√	√	√					R-SC5/10/1321BATR
										√	√	√		R-SC132/221-BATR
BALERO DELANTERO													√	R-SC200-2BALETRA
	√	√	√	√	√	√	√	√	√					R-SC5/10/1321BADE
										√	√	√		R-SC132/221-BADE
DESCARGA													√	R-SC200-2BALEDEL
	√	√	√	√	√	√	√							R-SC50/100DESCAR
								√	√	√	√			R-SC130DESCARGA
SUCCIÓN												√	√	R-SC200DESCARGA
	√	√	√											R-SC50SUCCION
				√	√	√	√							R-SC100SUCCION
SELLO MECÁNICO EPDM								√	√	√	√	√	√	R-SC130/200 SUC.
	√	√	√	√	√	√	√	√	√	√	√	√	√	R-SCSELLO/MECA
	√	√	√											R-SC50IMPULSOR
IMPULSOR COMPLETO				√	√	√	√							R-SC100IMPULSOR
								√	√	√	√			R-SC130IMPULSOR
												√	√	R-SC200IMPULSOR
IMP. RECOR								√	√			√		R-SC13/20IMPUREC
DIFUSOR	√	√	√											R-SC50DIFUSOR
								√	√	√	√	√	√	R-SC130/200DIFUS
DIF. ANILLO DE SELLADO					√	√	√	√						R-SC100DIFC/ANI
ANILLO DE SELLADO	√	√	√											R-SC50ANILLOSELLA
								√	√	√	√	√	√	R-SC130/200DIFUS
RETEN ANILLO SELLADO	√	√	√											R-SC50RETEN
								√	√	√	√	√	√	R-SC130/200RETEN
DIST. INTER	√	√	√											R-SC50DISTAINT
					√	√	√	√						R-SC100DISTAINT

ALTAMIRA®

REFACCIONES BOMBAS SCALA

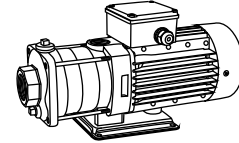

REFACCIÓN	SCALA50-4 /1115	SCALA 50-5/1230	SCALA50-5/3234	SCALA 100-3/1230	SCALA 100-3/3234	SCALA 100-4/1230	SCALA 100-4/3234	SCALA 130-2-1/1230	SCALA 130-2-1/3234	SCALA 130-2/1230	SCALA 130-2/3234	SCALA 200-2-1/3234	SCALA200-2/3234	CÓDIGO
SCALA130/200 DISTANC. INTER 28.5mm R-T/STVENT2-3HP								√	√	√	√	√	√	R-SC13/20DISTAIN
SCALA100 DISTANCIADOR INICIAL 28.5 MM				√	√	√	√							R-SC10DISTAINICIAL
DISTANCIADOR SUPERIOR 11.1 MM	√	√	√	√	√	√	√	√	√	√	√	√	√	R-SCDISTANSUPER
TUERCA SUPERIOR	√	√	√	√	√	√	√	√	√	√	√	√	√	R-SCTUECASUPER
SCALA BASE PARA BOMBA	√	√	√	√	√	√	√	√	√	√	√	√	√	R-SCBASE
SCALA 50,100 JUNTA TORICA	√	√	√	√	√	√	√							R-SC50/100JUNTA
SCALA 130,200 JUNTA TORICA								√	√	√	√	√	√	R-SC130/200JUNTA
SCALA 130,200 JUNTA TORICA "A"								√	√	√	√	√	√	R-SC130/200JUN/A
SCALA 50,100 TAPÓN DE PURGA/CEBADO	√	√	√	√	√	√	√							R-SC5/10TAPON
SCALA 130,200 JUNTA DE PURGA/CEBADO								√	√	√	√	√	√	R-SC13/20TAPON
SCALA 50-4,100-3 TIRANTE	√			√	√									R-SC50-4/10-3TIRAN
SCALA 50-5 TIRANTE		√	√											R-SC50-5TIRANTE
SCALA 100-4 TIRANTE						√	√							R-SC100-4TIRANTE
SCALA 130,200 TIRANTE								√	√	√	√	√	√	R-SC13/20TIRANTE
SCALA 100-4 Y X100-5 1F CLIXON						√	√							R-SC10-4/X10-5CLIX
SCALA 50-4 CAPACITOR 40 MF	√													R-SC50-4CAP40MF
SCALA 50-5,100-3 CAPACITOR 50 MF		√		√										R-SC5/10CAP50MF
SCALA 100-4,130-2-1 CAPACITOR 25 MF						√	√							R-SC10/13CAP25MF
SCALA 130-2/X100-5 CAPACITOR 30MF										√				R-SC132/X15CAP30MF
SCALA CANDADO SELLO MECÁNICO	√	√	√	√	√	√	√	√	√	√	√	√	√	R-SCCAND/SELLO
SCALA130/200 DIST. INTER 28.5MM								√	√	√	√	√	√	R-SC13/20DISTAIN
TABLILLA D/CONEX. P/SCALA 1.5HP 1F						√	√							R-SCALA-TC 1.5 1F
TABLILLA D/CONEX. P/SCALA 2HP 1F										√				R-SCALA-TC 2 1F
TABLILLA D/CONEX. P/SCALA 1-1.5HP 3F			√	√		√	√	√						R-SCALA-TC1-1.5 3F
TABLILLA D/CONEX. P/SCALA 2-4HP 3F										√		√		R-SCALA-TC2-4 3F

ALTAMIRA® REFACCIONES BOMBAS SCALAX

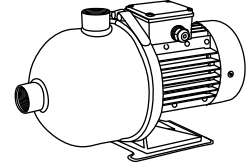

REFACCIÓN	SCALAX100-5/1230	SCALAX100-5/3234	CÓDIGO
CAPACITOR 30 MF	√		R-SC132/X15CAP30MF
TAPA VENTIADOR	√	√	R-T/STVENT2-3HP
VENTILADOR	√	√	R-T/SVENT2-4HP
CAJA DE	√		R-SC132/X105CC1F
CONEXIONES		√	R-SC132/20/X15CC3F
BALERO TRASERO	√	√	R-SC5/10/1321BATR
BALERO DELANTERO	√	√	R-SC5/10/1321BADE
CUERPO DE BOMBA	√	√	R-SCX100CUERPOB
SELLO MECÁNICO EPDM	√	√	R-SCX10SELLOMEC-R
IMPULSOR COMPLETO	√	√	R-SCX100IMPULSOR
DIFUSOR CON ANILLO SELLADO	√	√	R-SCX10DIFC/ANILLO
DISTANCIADOR 17 MM	√	√	R-SCX10DISTAINIC
DISTANCIADOR INT. A 4.5 MM	√	√	R-SC10XDISTAINTER
DISTANCIADOR GRA. B 13.3 MM	√	√	R-SC10X DISTAGRAF
DISTANCIADOR SUPERIOR 11.1 MM	√	√	R-SCDISTANSUPER
BASE PARA BOMBA	√	√	R-SCX100BASE
SCALAX100 JUNTA TÓRICA	√	√	R-SCX10JUNTATOR
SCALAX100 TAPÓN DE PURGA Y CEBADO	√	√	R-SCX100TAPON
SCALAX100 O-RING TAPÓN DE PURGA Y CEBADO	√	√	R-SCX100O-RTAP
SCALA100X ABRAZADERA	√	√	R-SCX100ABRAZAD
SCALA100X PERNO ROSCADO	√	√	R-SCX10PERNO
SCALA100X TUERCA PARA PERNO ROSCADO	√	√	R-SCX10TUERPERN
SCALA100X TAZÓN INFERIOR	√	√	R-SCX10TAZONINF
SCALA100X PARTE INTERNA DE SUCCIÓN	√	√	R-SCX10PARINTSUC
SCALAX100 O-RING PARTE INTERNA DE SUCCIÓN	√	√	R-SCX100R-OPAINSU
SCALA100X-5 TIRANTE	√	√	R-SCX10-5TIRANTE
SCALA100X TUERCA DEL TIRANTE	√	√	R-SCX10TUETIRAN
SCALA100X SOPORTE DE MOTOR	√	√	R-SCX10SOPORTMOT
TABLILLA D/CONEXIONES P/SCALA 2HP 1F	√		R-SCALA-TC 2 1F
TABLILLA D/CONEXIONES P/SCALA 2-4HP 3		√	R-SCALA-TC2-4 3F
SCALA CANDADO SELLO MECÁNICO	√	√	R-SCCAND/SELLO
SCALAX100 TUBO DE SUCCIÓN	√	√	R-SCX10 TUBOSUCC
SCALAX100 TAPA DIFUSOR	√	√	R-SCX100TAPADIF

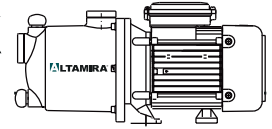
ALTAMIRA[®]
**REFACCIONES
MOTOBOMBAS ONIX**

REFACCIÓN	ONIX-B4-1127	ONIX-B5-1127	ONIX-B5-1230	CÓDIGO
BALERO No. 6202	√	√	√	R-LOT100/BALERO
BALERO No. 6203	√	√	√	R-LOT50/BALERO
CAJA DE CONEXIONES 127V	√	√		R-SUPRA/CCONEX
CAJA DE CONEXIONES 230V			√	R-SILVER/C.CONEX
CANDADO DE VENTILADOR	√	√	√	R-NJOB3HP-CV
CAPACITOR 35uF	√			R-LOT50/CAP1F127
CAPACITOR 50uF		√		R-LOT100-3CAP1F127
CAPACITOR 30MF			√	R-FLUXCAP30MF
CUERPO DE BOMBA	√	√	√	R-ONIX-CUER-BOMB-1
DIFUSOR PRIMARIO	√			R-ONIX-DIFUSOR-1
DIFUSOR	√	√	√	R-KP-DIFUSOR
IMPULSOR	√			R-ONIX-IMPULSOR-B4
		√	√	R-ONIX-IMPULSOR-B5
ORING	√	√	√	R-ONIX-ORING-6POS
	√	√	√	R-ONIX-ORING-15POS
ORING PARA TAPÓN DE CEBADO	√	√	√	R-SUP6-ORING-TAPON
PIE DE BOMBA	√	√	√	R-ONIX-PIE-BOMBA
REGLETA DE CONEXIONES 1F	√	√	√	R-ALY/REGLETA1F
SELLO MECÁNICO	√	√	√	R-ONIX-SELLO-MEC
SWITCH DE ENCENDIDO	√	√	√	R-SILVER15-SWE
TAPA DE CUERPO DE BOMBA	√	√	√	R-ONIX-TAPA-CBOMB
TAPA DE DIFUSOR	√	√	√	R-ONIX-TAPA-DIFUSO
TAPA DE VENTILADOR	√	√	√	R-ONIX-TAPA-VENT
TAPA FRONTAL DE MOTOR	√	√	√	R-ONIX-TAPA-MOTOR
TAPÓN DE CEBADO	√	√	√	R-SUP6-TAPON
VENTILADOR	√	√	√	R-ONIX-VENTILADOR

ALTAMIRA®

REFACCIONES MOTOBOMBA JOB

REFACCIÓN	JOB2 R30-6/3234	JOB2 R40-8/3234	JOB2 R55-10/3234	JOB3.5 R30-4/3234	JOB3.5 R40-6/3234	JOB3.5 R55-7/3234	CÓDIGO
BALERO 6203Z	√			√			R-NJOB-BAL-6203Z
BALERO 6205Z		√			√		R-NJOB-BAL-6205Z
BALERO 6206Z		√	√		√	√	R-NJOB-BAL-6206Z
BALERO 6304Z	√			√			R-NJOB-BAL-6304Z
BALERO 6306Z			√			√	R-NJOB-BAL-6306Z
CAMISA	√		√				R-NJOB2-10-CMA
		√					R-NJOB2-6-CMA
			√				R-NJOB2-8-CMA
				√			R-NJOB3.5-4-CMA
					√		R-NJOB3.5-6-CMA
CANDADO DE VENTILADOR	√			√			R-NJOB3.5-7-CMA
		√			√		R-NJOB3HP-CV
			√				R-NJOB4HP-CV
CASQUILLO	√	√	√	√	√	√	R-NJOB2-3.5-CQO
CILINDRO PARA COPLÉ	√	√	√	√	√	√	R-NJOB2-3.5-CPC
COPLÉ	√	√	√	√	√	√	R-NJOB2-3.5-COP
CUBIERTA COPLÉ	√	√	√	√	√	√	R-NJOB2-3.5-CCOP
DESCARGA 1.25" NPT	√						R-NJOB2-3HP-DSC
		√					R-NJOB2-4HP-DSC
			√				R-NJOB2-5HP-DSC
				√			R-NJOB3.5-3HP-DSC
						√	R-NJOB3.5-5HP-DSC
DIFUSOR	√	√	√		√		R-NJOB3.5-4HP-DSC
				√	√	√	R-NJOB2-DIF
DISTANCIADOR L29MM				√	√	√	R-NJOB3.5-DIF
DISTANCIADOR L23.5MM	√	√	√	√	√	√	R-NJOB2-3.5-D1
DISTANCIADOR L38.3MM				√	√	√	R-NJOB2-3.5-D2
EMPAQUE CAJA CONEXIONES	√	√		√	√		R-NJOB2-3.5-D3
			√			√	R-NJOB3-4HP-ECC
EMPAQUE DE CAMISA	√	√	√	√	√	√	R-NJOB5HP-ECC
IMPULSOR	√	√	√				R-NJOB2-3.5-OC
				√	√	√	R-NJOB2-IMP
KIT DE BRIDAS	√	√	√	√	√	√	R-NJOB3.5-IMP
SELLO MECÁNICO	√	√	√	√	√	√	R-NJOB2-3.5-KITBR
SUCCIÓN 1.5"	√	√	√				R-NJOB2-3.5-SM
				√	√	√	R-NJOB2-SCN
TABLILLA DE CONEXIONES	√			√			R-NJOB3.5-SCN
		√			√		R-NJOB3HP-TABC
			√			√	R-NJOB4HP-TABC
TAPA CAJA CONEXIONES	√	√		√	√		R-NJOB5HP-TABC
			√			√	R-NJOB3-4HP-TCC
TAPA DE VENTILADOR	√			√			R-NJOB5HP-TCC
		√			√		R-NJOB3HP-TVT
			√			√	R-NJOB4HP-TVT
TIRANTE			√				R-NJOB5HP-TVT
	√						R-NJOB2-10-TIRT
		√					R-NJOB2-6-TRT
				√			R-NJOB2-8-TRT
					√		R-NJOB3.5-4-TRT
TORNILLO Y EMPAQUE DRENADO	√	√	√	√	√	√	R-NJOB3.5-6-TRT
TUERCA HEXAGONAL	√	√	√	√	√	√	R-NJOB3.5-7-TRT
VÁLVULA DE ALIVIO	√	√	√	√	√	√	R-NJOB2-3.5-TYED
VENTILADOR	√			√			R-NJOB-THX
		√			√		R-NJOB2-3.5-VLVA
			√			√	R-NJOB3HP-VT
			√			√	R-NJOB4HP-VT
						√	R-NJOB5HP-VT

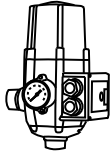

ALTAMIRA®

REFACCIONES PRES 10

REFACCIÓN	CÓDIGO
MEMBRANA	PRES10 MEMBRANA
TARJETA	PRES10 ELEC-CARD

REFACCIONES PRES 16

REFACCIÓN	CÓDIGO
TARJETA	R-PRES16-ELEC-CARD
MEMBRANA	R-PRES16-MEMBRANA

REFACCIONES KONTROLLSW



REFACCIÓN	KONTROLLSW 10T23	KONTROLLSW 16M12-23	CÓDIGO
BRIDA 1/4 NPT	√	√	R-KONTROLLSWBRIDAM
CUERPO Y TRANSDUCTOR	√	√	R-KONTROLLSWCT
TARJETA DE CONTROL	√	√	R-KONTROLLSWTCT
TAPA FRONTAL	√	√	R-KONTROLLSWTCTL
TARJETA DE POTENCIA	√	√	R-KONTROLLSWTCTF
			R-KONTROLLSWTCT
			R-KONTROLLSWT-TAP
			R-KONTROLLSWTP

REFACCIONES BOMBAS ALTAPRES

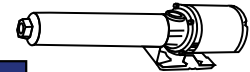

REFACCIÓN	ALTAPRES 03P05M	ALTAPRES 03P10M	ALTAPRES 08P10M	ALTAPRES 08P15M	ALTAPRES 08P15T	ALTAPRES 08P20T	ALTAPRES 16P20T	ALTAPRES 16P30T	CÓDIGO
IMPULSOR	√	√	√	√	√	√			7K1837
							√		7K35
								√	7K630
									7K19
DIFUSOR	√	√	√	√	√	√			7K1750
							√		7K17
								√	7K631
								√	7K20
SELLO MECÁNICO	√	√	√	√	√	√	√	10K10	
BALERO TRASERO	√	√	√	√	√	√	√	E1900	
BALERO DELANTERO	√		√	√	√				E1900
		√	√	√	√				B6205
						√	√	√	E1902
O-RING SUCC.-DESC.	√	√	√	√	√	√	√	5K225	
BUJE	√	√	√	√	√	√	√	7K1740	
SOPORTE ARANA	√	√	√	√	√	√	√	7K1372	
FLECHA CON COPLE	√								7K1817
		√				√			7K1826
			√						7K1824
				√	√				7K1825
							√		7K1834
								√	7K1835
TAZÓN	√	√							7K1838
			√	√	√	√			7K478
							√	√	7K18
									7K1797
CAMISA ENVOLVENTE	√								7K1806
		√				√			7K1804
			√		√				7K1805
				√	√				7K1814
							√		7K1814
								√	7K1815

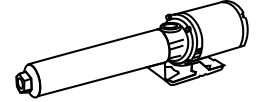
ALTAMIRA®
**REFACCIONES
BOMBAS ALTAPRES XT**

REFACCIÓN	ALTAPRS 22XT05/123	ALTAPRS 22XT10/1230	ALTAPRS 22XT15/1230	ALTAPRS 45XT10/1230	ALTAPRS 45XT15/1230	ALTAPRS 45XT20/1230	ALTAPRS 77XT10/1230	ALTAPRS 77XT15/1230	ALTAPRS 77XT20/1230	CÓDIGO
CAMISA	√			√						R-ALPXT22/45-CMS1
		√				√				R-ALPXT22/45-CMS2
			√							R-ALPXT22-CMS
					√					R-ALPXT45-CMS
							√			R-ALPXT77-CMS1
								√		R-ALPXT77-CMS2
CONJUNTO DE FLECHA	√			√					√	R-ALPXT77-CMS3
		√				√				R-ALPXT22/45-CF1
			√							R-ALPXT22/45-CF2
					√					R-ALPXT22-CF3
							√			R-ALPXT45-CF1
								√		R-ALPXT77-CF1
CONJUNTO HIDRAULICO	√	√	√						√	R-ALPXT77-CF2
				√	√	√				R-ALPXT77-CF3
										R-ALPXT22-CH
DESCARGA	√	√	√	√	√	√	√	√	√	R-ALPXT45-CH
	√	√	√	√	√	√	√	√	√	R-ALPXT77-CH
	√	√	√	√	√	√	√	√	√	R-ALPXT-DSCNPT1"
DISTANCIADOR	√	√	√	√	√	√	√	√	√	R-ALPXT-D2-37.6MM
ORING	√	√	√	√	√	√	√	√	√	R-ALPXT-OCMS
SELLO MECANICO	√	√	√	√	√	√	√	√	√	R-ALPXT-SM
SOPORTE ARAÑA	√	√	√	√	√	√	√	√	√	R-ALPXT-SAI
	√	√	√	√	√	√	√	√	√	R-ALPXT-SAS
VENTILADOR	√	√	√	√	√	√	√	√	√	R-ALPXT-VENTILADOR
						√			√	R-MAT2PVENT 4HP
TAPA DE VENTILADOR	√	√	√	√	√	√	√	√	√	R-MAT2PTVENT 1.5HP
						√			√	R-MAT2PTVENT 3HP
CAPACITOR	√									R-MAT2P/CAP50UF
		√		√			√			R-MAT2P/CAP25UF
			√		√			√		R-MAT2P/CAP30UF
						√			√	R-MAT2P/CAP40UF
CAJA DE CONEXIONES	√	√		√			√			R-ALPXT-CAJA-1
			√		√			√		R-ALPXT-CAJA-2
						√		√		R-MAT2PCC1F3HP
TERMINALES	√									R-SCALA-TC3/4-1 1F
		√	√	√	√		√	√		R-SCALA-TC 1.5 1F
						√		√	√	R-SCALA-TC 2 1F

ALTAMIRA®
**REFACCIONES
EVOPRES-16**

REFACCIÓN	EVOPRES-16	CÓDIGO
TARJETA DE CONTROL	√	R-EVO-T-CONTROL
TARJETA DE POTENCIA	√	R-EVO-T-POTENCIA
MEMBRANA	√	R-EVO-MEMBRANA

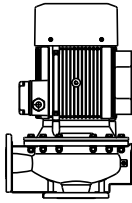

REFACCIÓN	FLUX4-1.51230	FLUX4-1.53234	FLUX4-21230	FLUX4-23234	FLUX4-31230	FLUX4-33234	FLUX5-43234	FLUX5-5.53234	FLUX5-7.53234	FLUX7-21230	FLUX7-23234	FLUX7-31230	FLUX7-33234	FLUX7-43234	FLUX7-5.53234	FLUX7-7.53234	FLUX7-103234	FLUX7-153234	FLUX12-43234	FLUX12-5.53234	FLUX12-7.53234	CÓDIGO
BALERO 6205Z	✓	✓	✓	✓	✓	✓	✓	✓	✓	✓	✓	✓	✓	✓	✓	✓	✓	✓	✓	✓	✓	R-FLUX-BALERO1
BALERO 6203Z (AC)	✓	✓	✓	✓	✓	✓	✓	✓	✓	✓	✓	✓	✓	✓	✓	✓	✓	✓	✓	✓	✓	R-FLUX-BALERO2
BALERO 6205Z (AC)	✓	✓	✓	✓	✓	✓	✓	✓	✓	✓	✓	✓	✓	✓	✓	✓	✓	✓	✓	✓	✓	R-FLUX-BALERO3
BALERO 6206Z	✓	✓	✓	✓	✓	✓	✓	✓	✓	✓	✓	✓	✓	✓	✓	✓	✓	✓	✓	✓	✓	R-FLUX-BALERO4
BALERO 6206 (AC)	✓	✓	✓	✓	✓	✓	✓	✓	✓	✓	✓	✓	✓	✓	✓	✓	✓	✓	✓	✓	✓	R-FLUX-BALERO5
BALERO 6306Z	✓	✓	✓	✓	✓	✓	✓	✓	✓	✓	✓	✓	✓	✓	✓	✓	✓	✓	✓	✓	✓	R-FLUX-BALERO6
BALERO 6308Z	✓	✓	✓	✓	✓	✓	✓	✓	✓	✓	✓	✓	✓	✓	✓	✓	✓	✓	✓	✓	✓	R-FLUX-BALERO7
CUERPO DE BOMBA	✓	✓	✓	✓	✓	✓	✓	✓	✓	✓	✓	✓	✓	✓	✓	✓	✓	✓	✓	✓	✓	R-FLUX4-CUEBOMBA
																						R-FLUX5-CUEBOMBA
																						R-FLUX7-CUEBOMBA1
																						R-FLUX7-CUEBOMBA2
																						R-FLUX7-CUEBOMBA3
																						R-FLUX12-CUEBOMBA1
																						R-FLUX12-CUEBOMBA2
CAPACITOR 30MF	✓	✓	✓	✓	✓	✓	✓	✓	✓	✓	✓	✓	✓	✓	✓	✓	✓	✓	✓	✓	✓	R-FLUXCAP30MF
CAPACITOR 40MF	✓	✓	✓	✓	✓	✓	✓	✓	✓	✓	✓	✓	✓	✓	✓	✓	✓	✓	✓	✓	✓	R-FLUXCAP40MF
CAPACITOR 50MF	✓	✓	✓	✓	✓	✓	✓	✓	✓	✓	✓	✓	✓	✓	✓	✓	✓	✓	✓	✓	✓	R-FLUXCAP50MF
IMPULSOR	✓	✓	✓	✓	✓	✓	✓	✓	✓	✓	✓	✓	✓	✓	✓	✓	✓	✓	✓	✓	✓	R-FLUX4-1.51MP
																						R-FLUX4-2IMP
																						R-FLUX4-3IMP
																						R-FLUX4-4IMP
																						R-FLUX5-5IMP
																						R-FLUX5-7.5IMP
																						R-FLUX7-2IMP
																						R-FLUX7-3IMP
																						R-FLUX7-4IMP
																						R-FLUX7-5.5IMP
																						R-FLUX7-7.5IMP
																						R-FLUX7-10IMP
																						R-FLUX7-15IMP
																						R-FLUX12-4IMP
																						R-FLUX12-5.5IMP
																						R-FLUX12-7.5IMP
ORING CUERPO DE BOMBA	✓	✓	✓	✓	✓	✓	✓	✓	✓	✓	✓	✓	✓	✓	✓	✓	✓	✓	✓	✓	✓	R-FLUXORING1
																						R-FLUXORING2
																						R-FLUXORING3
PLATO PORTA SELLO	✓	✓	✓	✓	✓	✓	✓	✓	✓	✓	✓	✓	✓	✓	✓	✓	✓	✓	✓	✓	✓	R-FLUX-PPSELLO1
																						R-FLUX-PPSELLO2
																						R-FLUX-PPSELLO3
																						R-FLUX-PPSELLO4
SELLO MECANICO	✓	✓	✓	✓	✓	✓	✓	✓	✓	✓	✓	✓	✓	✓	✓	✓	✓	✓	✓	✓	✓	R-FLUX-SELLOM1
																						R-FLUXVENT
VENTILADOR	✓	✓	✓	✓	✓	✓	✓	✓	✓	✓	✓	✓	✓	✓	✓	✓	✓	✓	✓	✓	✓	R-FLUXVENT1
																						R-FLUXVENT2
																						R-FLUXVENT3

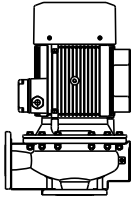

ALTAMIRA® REFACCIONES BOMBAS FLUX

REFACCIÓN	FLUX12-103234	FLUX12-12.53234	FLUX12-153234	FLUX12-203234	FLUX12-253234	FLUX24-5.53234	FLUX24-7.53234	FLUX24-103234	FLUX24-12.53234	FLUX28-153234	FLUX28-203234	FLUX28-253234	FLUX28-303234	FLUX28-403234	FLUX38-153234	FLUX38-203234	FLUX38-253234	FLUX44-503234	CÓDIGO
BALERO 6206Z						✓													R-FLUX-BALER04
BALERO 6206 (AC)						✓													R-FLUX-BALER05
BALERO 6306Z	✓					✓													R-FLUX-BALER06
BALERO 6308Z		✓																	R-FLUX-BALER07
BALERO 6309Z			✓																R-FLUX-BALER08
BALERO 6211 2RS																			R-FLUX-BALER09
BALERO 6212RS	✓																		R-FLUX-BALER10
CUERPO DE BOMBA																			R-FLUX12-CUEBOMBA2
																			R-FLUX24-CUEBOMBA
																			R-FLUX28-CUEBOMBA1
																			R-FLUX28-CUEBOMBA2
																			R-FLUX38-CUEBOMBA
																			R-FLUX44-CUEBOMBA
		✓																	R-FLUX12-10IMP
			✓																R-FLUX12-12.5IMP
				✓															R-FLUX12-15IMP
					✓														R-FLUX12-20IMP
						✓													R-FLUX12-25IMP
							✓												R-FLUX24-5IMP
IMPULSOR																			R-FLUX24-7.5IMP
																			R-FLUX24-10IMP
																			R-FLUX24-12.5IMP
																			R-FLUX28-15IMP
																			R-FLUX28-20IMP
																			R-FLUX28-25IMP
																			R-FLUX28-30IMP
																			R-FLUX28-40IMP
																			R-FLUX38-15IMP
																			R-FLUX38-20IMP
																			R-FLUX44-30IMP
																			R-FLUX44-40IMP
ORING CUERPO DE BOMBA																			R-FLUX44-50IMP
																			R-FLUXORING2
																			R-FLUXORING3
PLATO PORTA SELLO																			R-FLUX-PPSELLO2
																			R-FLUX-PPSELLO3
SELLO MECANICO																			R-FLUX-SELLOM1
																			R-FLUX-SELLOM2
																			R-FLUXVENT2
																			R-FLUXVENT3
VENTILADOR																			R-FLUXVENT4
																			R-FLUXVENT5
																			R-FLUXVENT6

ALTAMIRA®

REFACCIONES BOMBAS FLUX 55 y 83

REFACCIÓN	FLUX55-253234	FLUX55-303234	FLUX55-403234	FLUX55-503234	FLUX55-603234	FLUX55-753234	FLUX83-603234	FLUX83-753234	FLUX83-1003234	FLUX83-1203234	CÓDIGO
BALERO	√										R-FLUX55-25-BAL
		√									R-FLUX55-30-BAL
			√	√							R-FLUX55-40/50-BAL
					√		√				R-FLUX55/83-60-BAL
						√		√			R-FLUX55/83-75-BAL
CUERPO DE BOMBA									√	√	R-FLUX83-120-BAL
	√	√	√								R-FLUX55-25-40-CB
				√	√	√					R-FLUX55-50-75-CB
							√	√	√	√	R-FLUX83-60-120-CB
IMPULSOR	√										R-FLUX55-25-IMP
		√									R-FLUX55-30-IMP
			√								R-FLUX55-40-IMP
				√							R-FLUX55-50-IMP
					√						R-FLUX55-60-IMP
						√					R-FLUX55-75-IMP
							√				R-FLUX83-60-IMP
								√			R-FLUX83-75-IMP
ORING DE CUERPO DE BOMBA	√	√	√								R-FLUX55-OCB
				√	√	√	√	√	√	√	R-FLUX55/83-OCB
SELLO MECANICO	√										R-FLUX-SELLOM1
		√	√								R-FLUX-SELLOM2
				√	√	√	√	√	√	√	R-FLUX55-50/83-SM
VENTILADOR	√										R-FLUX55-25-VT
		√									R-FLUX55-30-VT
			√	√							R-FLUX55-40-50-VT
					√		√				R-FLUX55/83-60-VT
						√		√			R-FLUX55/83-75-VT
TAPA DE VENTILADOR									√	√	R-FLUX83-100/120-VT
	√										R-FLUX55-25-TVT
		√									R-FLUX55-30-TVT
			√	√							R-FLUX55-40-50-TVT
					√		√				R-FLUX55/83-60-TVT
BRIDA					√		√				R-FLUX55/83-75-TVT
									√	√	R-FLUX83-100/120TVT
	√	√	√	√	√	√					FLUXKB-DN6X4
							√	√	√	√	FLUXKB-DN6X6
PLATO PORTA SELLO	√										R-FLUX-PPSELLO2
		√	√								R-FLUX55-30-40-PPS
			√	√	√	√	√	√	√	√	R-FLUX55-50/83-PPS

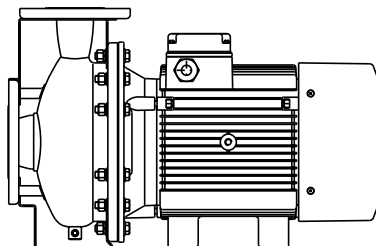

ALTAMIRA® REFACCIONES BOMBAS LOTUS

REFACCIÓN	LOTUS50 -4/1127	LOTUS50 -4/1230	LOTUS50 -4/3234	LOTUS50 -5/1127	LOTUS50 -5/1230	LOTUS50 -6/1127	LOTUS50 -6/1230	CÓDIGO
ADAPTADOR SUCCIÓN	√	√	√		√			R-LOT50-4/ADAPSUC
				√	√			R-LOT50-5/ADAPSUC
						√	√	R-LOT50-6/ADAPSUC
BALERO 6202	√	√	√	√	√	√	√	R-LOT100/BALERO
BALERO 6203	√	√	√	√	√	√	√	R-LOT50/BALERO
CAJA DE CONEXIONES	√			√				R-LOTUS-CC1
		√			√			R-LOTUS-CC2
						√		R-LOTUS-CC3
							√	R-LOTUS-CC4
			√					R-LOTUS-CC5
CAPACITORES 35mf	√			√		√		R-LOT50/CAP1F127
CAPACITORES					√		√	R-LOT50/CAP1F230
CUERPO DE BOMBA	√	√	√	√	√	√	√	R-LOT50/CUERPOB
DIFUSOR	√	√	√	√	√	√	√	R-LOT50/DIFUSOR
	√	√	√	√	√	√	√	R-LOT50/DIFUINTER
	√	√	√	√	√	√	√	R-LOT50/DIFUINF
DISTANCIADOR	√	√	√	√	√	√	√	R-LOT50/DISTSUP
	√	√	√	√	√	√	√	R-LOT50/DISTINTER
	√	√	√	√	√	√	√	R-LOT50/DISTINIC
EMPAQUE CAJA DE CONEXIONES	√	√	√	√	√	√	√	R-LOT-OR-TCC-A
			√					R-LOT50/EMPCC3F
IMPULSOR	√	√	√	√	√	√	√	R-LOT50/IMPULS
ORING CUERPO DE BOMBA	√	√	√	√	√	√	√	R-LOT50/ORINGCB
ORING SUCCIÓN	√	√	√	√	√	√	√	R-LOT50/ORINGSUC
PLATO PORTA SELLO	√	√	√	√	√	√	√	R-LOT50/PLATOPSE
PLATO SUPERIOR	√	√	√	√	√	√	√	R-LOT50/PLATOSUP
SELLO MECANICO	√	√	√	√	√	√	√	R-LOT50/SELLOMEC
SOPORTE CUERPO DE BOMBA	√	√	√	√	√	√	√	R-LOT50/SOPORCB
SUJETADOR	√	√	√	√	√	√	√	R-LOT50/SUJETAD
TAPA DE MOTOR	√	√	√	√	√	√	√	R-LOT50/TAPMOT
TAPA DE VENTILADOR	√	√	√	√	√	√	√	R-LOT50/TAPVENT
TIRANTE	√	√	√					R-LOT50-4/TIRANTE
				√	√			R-LOT50-5/TIRANTE
						√	√	R-LOT50-6/TIRANTE
VENTILADOR	√	√	√	√	√	√	√	R-LOT50/VENT

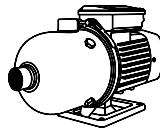

REFACCIÓN	LOTUS100 -3/1127	LOTUS100 -3/1230	LOTUS100 -3/3234	LOTUS100 -4/1127	LOTUS100 -4/1230	LOTUS100 -4/3234	CÓDIGO
ADAPTADOR SUCCIÓN	√	√	√				R-LOT100-3/ADAPSUC
				√	√	√	R-LOT50-4/ADAPSUC
						√	R-LOT100/BALERO
BALERO 6202	√	√	√	√	√	√	R-LOT50/BALERO
BALERO 6203	√	√	√	√	√	√	R-LOT50/BALERO
CAJA DE CONEXIONES	√			√			R-LOTUS-CC3
		√			√		R-LOTUS-CC4
			√			√	R-LOTUS-CC5
CAPACITORES 30mf		√			√		R-LOT100/CAP1F230
CAPACITORES 50mf	√			√			R-LOT100-3CAP1F127
CUERPO DE BOMBA	√	√	√	√	√	√	R-LOT100/CUERPOB
DIFUSOR	√	√	√	√	√	√	R-LOT50/DIFUSOR
	√	√	√	√	√	√	R-LOT50/DIFUINTER
	√	√	√	√	√	√	R-LOT50/DIFUINF
DISTANCIADOR	√	√	√	√	√	√	R-LOT50/DISTSUP
	√	√	√	√	√	√	R-LOT50/DISTINTER
	√	√	√	√	√	√	R-LOT50/DISTINIC
EMPAQUE CAJA DE CONEXIONES	√	√	√	√	√	√	R-LOT-OR-TCC-A
			√			√	R-LOT50/EMPCC3F
IMPULSOR	√	√	√	√	√	√	R-LOT100/IMPULS
ORING CUERPO DE BOMBA	√	√	√	√	√	√	R-LOT50/ORINGCB
ORING SUCCIÓN	√	√	√	√	√	√	R-LOT50/ORINGSUC
PLATO PORTA SELLO	√	√	√	√	√	√	R-LOT50/PLATOPSE
PLATO SUPERIOR	√	√	√	√	√	√	R-LOT50/PLATOSUP
SELLO MECANICO	√	√	√	√	√	√	R-LOT50/SELLOMEC
SOPORTE CUERPO DE BOMBA	√	√	√	√	√	√	R-LOT50/SOPORCB
SUJETADOR	√	√	√	√	√	√	R-LOT50/SUJETAD
TAPA DE MOTOR	√	√	√	√	√	√	R-LOT50/TAPMOT
TAPA DE VENTILADOR	√	√	√	√	√	√	R-LOT50/TAPVENT
TIRANTE	√	√	√	√	√	√	R-LOT50-4/TIRANTE
				√	√		R-LOT100-3/TIRANTE
VENTILADOR	√	√	√	√	√	√	R-LOT50/VENT

ALTAMIRA® REFACCIONES BOMBAS LOTUS

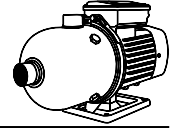

REFACCIÓN	LOTUS150 -3/1230	LOTUS150 -3/3234	LOTUS150 -4/3234	LOTUS150 -5/3234	LOTUS200 -2/3234	LOTUS200 -2-1/1230	LOTUS200 -2-1/3234	LOTUS200 -3/3234	CÓDIGO
ADAPTADOR SUCCIÓN	√	√						√	R-LOT150-3/ADAPSUC
			√						R-LOT150-4/ADAPSUC
				√					R-LOT150-5/ADAPSUC
					√	√	√		R-LOT200/ADAPSUC
BALERO 6204	√	√	√	√	√	√	√	√	R-LOT150/BALFRONT
BALERO 6205	√	√	√	√	√	√	√	√	R-LOT150/BALTRASE
CAJA DE CONEXIONES	√		√	√	√	√		√	R-LOTUS-CC6
		√					√		R-LOTUS-CC5
CAPACITORES 25mf	√					√			R-LOT200/CAP
CUERPO DE BOMBA	√	√	√		√	√	√	√	R-LOT150/CUERPOB
				√					R-LOT150-5/CUERPOB
DIFUSOR	√	√	√	√	√	√	√	√	R-LOT150/DIFUINTER
	√	√	√	√	√	√	√	√	R-LOT150/DIFUINF
DISTANCIADOR INICIAL	√	√	√	√	√	√	√	√	R-LOT150/DISTINIC
DISTANCIADOR INTERMEDIO	√	√	√	√	√	√	√	√	R-LOT150/DISTINTER
DISTANCIADOR SUPERIOR	√	√	√	√	√	√	√	√	R-LOT150/DISTSUP
EMPAQUE CAJA DE CONEXIONES	√	√	√	√		√		√	R-LOT50/EMPC3F
					√		√		R-LOT-OR-TCC-B
IMPULSOR	√	√	√	√					R-LOT150/IMPULS
					√	√	√		R-LOT200/IMPULS
								√	R-LOT200-3/IMPULS
ORING CUERPO DE BOMBA	√	√	√	√	√	√	√	√	R-LOT150/ORINGCB
ORING SUCCIÓN	√	√	√	√	√	√	√	√	R-LOT150/ORINGSUC
PLATO PORTA SELLO	√	√	√	√	√	√	√	√	R-LOT150/PLATOPSE
PLATO SUPERIOR	√	√	√	√	√	√	√	√	R-LOT150/PLATSUP
SELLO MECANICO	√	√	√	√	√	√	√	√	R-LOT150/SELLOMEC
SOPORTE CUERPO DE BOMBA		√					√		R-LOT150/SOPOTCB
	√		√	√	√	√		√	R-LOT200/SOPORCB
SUJETADOR	√	√	√	√	√	√	√	√	R-LOT150/SUJETAD
TAPA DE MOTOR	√								R-LOT150/TAPMOT1F
		√	√	√					R-LOT150/TAPMOT3F
					√				R-LOT200-2/TAPMOT
						√			R-LOT200-2-1TAPM1F
							√	√	R-LOT200/TAPMOT
TAPA DE VENTILADOR		√	√	√	√		√		R-LOT150/TAPVENT
						√		√	R-LOT200/TAPVENT
TIRANTE			√						R-LOT150-4/TIRANTE
				√					R-LOT150-5/TIRANTE
					√				R-LOT200/TIRANTE
	√	√						√	R-LOT200-3/TIRANTE
VENTILADOR	√	√	√	√					R-LOT150/VENT
					√	√	√		R-LOT200/VENT
								√	R-LOT200-3/VENT

REFACCIÓN	JOB2 R30-6	JOB2 R40-8	JOB2 R55-10	JOB3.5 R30-4	JOB3.5 R40-6	JOB3.5 R55-7	CÓDIGO
TAPA DE VENTILADOR	√			√			R-JOB3HP TVENT
		√			√		R-JOB4-5HP TVENT
CANDADO PARA VENTILADOR			√			√	R-JOB4-5HP TVENT
	√			√			R-JOB3HP CAND.VENT
VENTILADOR	√			√			R-JOB3HP VENT
		√			√		R-JOB4-5HP VENT
			√			√	R-JOB4-5HP VENT
EMPAQUE PARA CAJA DE CONEXIONES	√	√	√	√	√	√	R-JOB EMP.CC3F
REGLETA PARA CAJA DE CONEXIONES	√	√	√	√	√	√	R-JOB REGLETA
CAJA DE CONEXIONES	√	√	√	√	√	√	R-JOB CC
BALERO SUPERIOR	√			√			R-JOB3HP BS
BALERO INFERIOR	√			√			R-JOB3HP BINF
		√			√		R-JOB4HP BINF
DESCARGA	√			√			R-JOB3HP DESC
		√			√		R-JOB4HP DESC
			√			√	R-JOB5HP DESC
KIT DE BRIDAS	√	√	√	√	√	√	R-JOB KITBRIDAS
SELLO MECÁNICO	√	√	√	√	√	√	R-JOB SELLO
DISTANCIADOR	√	√	√				R-JOB2 DIST
				√	√	√	R-JOB3.5 DIST-A
				√	√	√	R-JOB3.5 DIST-B
DIFUSOR	√	√	√				R-JOB2 DIFUSORC
				√	√	√	R-JOB3.5 DIFUSORC
CASQUILLO CORTO				√	√	√	R-JOB3.5CASQCORT
CASQUILLO LARGO				√	√	√	R-JOB3.5CASQLARGO
ARANDELA	√	√	√	√	√	√	R-JOB ARAN
ARANDELA DE SEGURIDAD	√	√	√	√	√	√	R-JOB ARANSEG
TORNILLO HEXAGONAL	√	√	√	√	√	√	R-JOB THEX
O-RING PARA CAMISA	√	√	√	√	√	√	R-JOB O-RINGC
CAMISA	√						R-JOB2-6 CAMISA
		√					R-JOB2-8 CAMISA
			√				R-JOB2-10 CAMISA
				√			R-JOB3.5-4 CAMISA
					√		R-JOB3.5-6 CAMISA
					√	R-JOB3.5-7 CAMISA	
EMPAQUE DE DRENADO	√	√	√	√	√	√	R-JOB EMP.DREN
ARANDELA PARA TIRANTE	√	√	√	√	√	√	R-JOB ARANT
TIRANTES	√						R-JOB2-6 TIRANTE
		√					R-JOB2-8 TIRANTE
			√				R-JOB2-10 TIRANTE
				√			R-JOB3.5-4 TIRANTE
					√		R-JOB3.5-6 TIRANTE
						√	R-JOB3.5-7 TIRANTE
IMPULSOR (FLECHA ESTRIADA)	√	√	√				R-JOB2 IMPULSORB
				√	√	√	R-JOB3.5 IMPULSORB

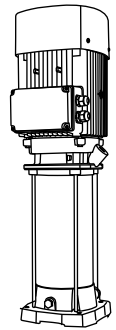

STACK KIT BOMBAS TX

CÓDIGO	DESCRIPCIÓN	
T0.6 X05-2/ST	T0.6X STACK KIT	
T0.6 X05-3/ST		
T0.6 X05-4/ST		
T0.6 X07-5/ST		
T0.6 X07-6/ST		
T0.6 XE10-7/ST		
T0.6 X10-8/ST		
T0.6 X10-9/ST		
T0.6 X15-10/ST		
T0.6 X15-11/ST		
T0.6 XE15-12/ST		
T0.6 X15-13/ST		
T0.6 X20-15/ST		
T0.6 X20-17/ST		
T0.6 X30-19/ST		
T0.6 X30-21/ST		
T0.6 X30-23/ST		
T0.6 X30-25/ST		
T0.6 X40-27/ST		
T1 X05-2/ST		T1X STACK KIT
T1 X07-3/ST		
T1 X07-4/ST		
T1 X10-5/ST		
T1 X15-6/ST		
T1 XE15-7/ST		
T1 X15-8/ST		
T1 X20-9/ST		
T1 X20-10/ST		
T1 X20-11/ST		
T1 X30-12/ST		
T1 X30-13/ST		
T1 X30-15/ST		
T1 X30-17/ST		
T1 X40-19/ST		
T1 X40-21/ST		
T1 X40-23/ST		
T1 X55-25/ST		
T2 X07-2/ST	T2X STACK KIT	
T2 X15-3/ST		
T2 X15-4/ST		
T2 X20-5/ST		
T2 X30-6/ST		
T2 X30-7/ST		
T2 X30-8/ST		
T2 X30-9/ST		
T2 XE40-10/ST		
T2 X40-11/ST		
T2 X40-12/ST		
T2 X55-13/ST		
T2 X55-14/ST		
T2 X55-15/ST		
T2 X55-16/ST		
T2 X75-18/ST		
T2 X75-20/ST		
T2 X75-22/ST		
T2 X100-24/ST		

STACK KIT BOMBAS TX

CÓDIGO	DESCRIPCIÓN
T3.5 X10-1/ST	T3.5X STACK KIT
T3.5 X20-2/ST	
T3.5 X30-3/ST	
T3.5 X40-4/ST	
T3.5 X40-5/ST	
T3.5 X55-6/ST	
T3.5 XE75-7/ST	
T3.5 X75-8/ST	
T3.5 X75-9/ST	
T3.5 X100-10/ST	
T3.5 X100-12/ST	
T3.5 X150-14/ST	
T3.5 X150-16/ST	
T3.5 X150-17/ST	
T6 X20-1/ST	
T6 X40-2/ST	
T6 X55-3/ST	
T6 X75-4/ST	
T6 X100-5/ST	
T6 X150-6/ST	
T6 X150-7/ST	
T6 X150-8/ST	
T6 X200-9/ST	
T6 X200-10/ST	
T6 X250-12/ST	
T7.5 X30-1/ST	T7.5X STACK KIT
T7.5 X55-2/ST	
T7.5 X75-3/ST	
T7.5 X100-4/ST	
T7.5 X150-5/ST	
T7.5 X150-6/ST	
T7.5 X200-7/ST	
T7.5 X200-8/ST	
T7.5 X250-10/ST	
T10 X30-1-1/ST	
T10 X40-1/ST	
T10 X75-2-2/ST	
T10 X75-2-1/ST	
T10 X100-2/ST	
T10 X150-3-2/ST	
T10 X150-3/ST	
T10 X150-4-2/ST	
T10 X200-4/ST	
T10 X200-5-2/ST	
T10 X250-5/ST	
T10 X250-6-2/ST	
T10 X250-6/ST	
T10 X300-7-2/ST	
T10 X300-7/ST	
T10 X400-8-2/ST	
T10 X400-8/ST	
T10 X400-9-2/ST	
T10 X400-9/ST	
T10 X400-10-2/ST	

STACK KIT BOMBAS TX

CÓDIGO	DESCRIPCIÓN	
T13 X75-1-1/ST	T13X STACK KIT	
T13 X100-1/ST		
T13 X150-2-2/ST		
T13 X150-2-1/ST		
T13 X200-2/ST		
T13 X250-3-2/ST		
T13 X250-3-1/ST		
T13 X250-3/ST		
T13 X300-4-2/ST		
T13 X400-4-1/ST		
T13 X400-4/ST		
T13 X400-5-2/ST		
T13 X400-5-1/ST		
T13 X400-5/ST		
T13 X500-6-2/ST		
T13 X500-6-1/ST		
T13 X500-6/ST		
T13 X600-7-2/ST		
T13 X600-7-1/ST		
T13 X600-7/ST		
T21 X100-1-1/ST	T21X STACK KIT	
T21 X150-1/ST		
T21 X200-2-2/ST		
T21 X250-2-1/ST		
T21 X300-2/ST		
T21 X300-3-2/ST		
T21 X400-3-1/ST		
T21 X400-3/ST		
T21 X500-4-2/ST		
T21 X500-4-1/ST		
T21 X600-4/ST		
T21 X600-5-2/ST	T29X STACK KIT	
T29 X150-1-1/ST		
T29 X200-1/ST		
T29 X250-2-2/ST		
T29 X300-2-1/ST		
T29 X400-2/ST		
T29 X500-3-2/ST		
T29 X500-3-1/ST		
T29 X600-3/ST		
T29 X600-4-2/ST		
T33 X250-1/ST	T33X STACK KIT	
T33 X400-2-2/ST		
T33 X400-2-1/ST		
T33 X500-2/ST		
T33 X600-3-1/ST		
T33 X750-3/ST		
T33 X1000-4-1/ST		
T33 X1000-5-2/ST		
T41 X250-1-1/ST		T41X STACK KIT
T41 X300-1/ST		
T41 X400-2-2/ST		
T41 X500-2-1/ST		
T41 X600-2/ST		
T41 X750-3-2/ST		
T41 X1000-3/ST		
T41 X1000-4-2/ST		



SELLOS MECÁNICOS PARA BOMBAS TX Y TXE

- Estándar tipo cartucho
- En carburo de silicio
- Cuerpo en acero inoxidable 304
- De fácil reemplazo, sin necesidad de desensamblar la bomba

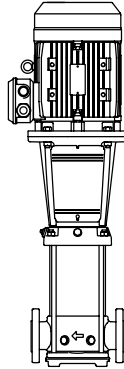

TIPO DE SELLO	TX	TXE	TXN
SELLO MECÁNICO			
Sello tipo cartucho	Estándar	Estándar	Estándar
Carburo de silicio / Carburo de silicio	Estándar	Estándar	Estándar
Carburo de tungsteno / Carburo de tungsteno	Opcional	Opcional	Opcional
Carburo de silicio / carbón	Opcional	Opcional	Opcional
JUEGO DE EMPAQUES (O'ring)			
EPDM	Opcional	Opcional	Opcional
Vitón	Estándar	Estándar	Estándar

MODELO DE LA BOMBA	CÓDIGO
T0.6 X05-2	T0.6-2XE-KSEMCA
T0.6 X05-3	
T0.6 X05-4	
T0.6 X07-5	
T0.6 X07-6	
T0.6 X10-7	
T0.6 X10-8	
T0.6 X10-9	
T0.6 X15-10	
T0.6 X15-11	
T0.6 X15-12	
T0.6 X15-13	
T0.6 X20-15	
T0.6 X20-17	
T0.6 X30-19	
T0.6 X30-21	
T0.6 X30-23	
T0.6 X30-25	
T0.6 X40-27	
T1 X05-2	
T1 X07-3	
T1 X07-4	
T1 X10-5	
T1 X15-6	
T1 X15-7	
T1 X15-8	
T1 X20-9	
T1 X20-10	
T1 X20-11	
T1 X30-12	
T1 X30-13	
T1 X30-15	
T1 X30-17	
T1 X40-19	
T1 X40-21	
T1 X40-23	
T1 X55-25	
T2 X07-2	
T2 X15-3	
T2 X15-4	
T2 X20-5	
T2 X30-6	
T2 X30-7	
T2 X30-8	
T2 X30-9	
T2 X40-10	
T2 X40-11	
T2 X40-12	
T2 X55-13	
T2 X55-14	
T2 X55-15	
T2 X55-16	
T2 X75-18	
T2 X75-20	
T2 X75-22	
T2 X100-24	

MODELO DE LA BOMBA	CÓDIGO
T3.5 X10-1	TX3.5/7.5SELL/VIT
T3.5 X20-2	
T3.5 X30-3	
T3.5 X40-4	
T3.5 X40-5	
T3.5 X55-6	
T3.5 X75-7	
T3.5 X75-8	
T3.5 X75-9	
T3.5 X100-10	
T3.5 X100-12	
T3.5 X150-14	
T3.5 X150-16	
T3.5 X150-17	
T6 X20-1	
T6 X40-2	
T6 X55-3	
T6 X75-4	
T6 X100-5	
T6 X150-6	
T6 X150-7	
T6 X150-8	
T6 X200-9	
T6 X200-10	
T6 X250-12	
T7.5 X30-1	
T7.5 X55-2	
T7.5 X75-3	
T7.5 X100-4	
T7.5 X150-5	
T7.5 X150-6	
T7.5 X200-7	
T7.5 X200-8	
T7.5 X250-10	
T10 X30-1-1	TX10/13 SELL/VIT
T10 X40-1	
T10 X75-2-2	
T10 X75-2-1	
T10 X100-2	
T10 X150-3-2	
T10 X150-3	
T10 X150-4-2	
T10 X200-4	
T10 X200-5-2	
T10 X250-5	
T10 X250-6-2	
T10 X250-6	
T10 X300-7-2	
T10 X300-7	
T10 X400-8-2	
T10 X400-8	
T10 X400-9-2	
T10 X400-9	
T10 X400-10-2	

MODELO DE LA BOMBA	CÓDIGO
T13 X7.5-1-1	TX10/13 SELL/VIT
T13 X100-1	
T13 X150-2-2	
T13 X150-2-1	
T13 X200-2	
T13 X250-3-2	
T13 X250-3-1	
T13 X250-3	
T13 X300-4-2	
T13 X400-4-1	
T13 X400-4	
T13 X400-5-2	
T13 X400-5-1	
T13 X400-5	
T13 X500-6-2	
T13 X500-6-1	
T13 X500-6	
T13 X600-7-2	
T13 X600-7-1	
T13 X600-7	
T21 X100-1-1	
T21 X150-1	
T21 X200-2-2	
T21 X250-2-1	
T21 X300-2	
T21 X300-3-2	
T21 X400-3-1	
T21 X400-3	
T21 X500-4-2	
T21 X500-4-1	
T21 X600-4	
T21 X600-5-2	
T29 X150-1-1	
T29 X200-1	
T29 X250-2-2	
T29 X300-2-1	
T29 X400-2	
T29 X500-3-2	
T29 X500-3-1	
T29 X600-3	
T29 X600-4-2	
T33 X250-1	
T33 X400-2-2	
T33 X400-2-1	
T33 X500-2	
T33 X600-3-1	
T33 X750-3	
T33 X1000-4-1	
T33 X1000-5-2	
T41 X250-1-1	
T41 X300-1	
T41 X400-2-2	
T41 X500-2-1	
T41 X600-2	
T41 X750-3-2	
T41 X1000-3	
T41 X1000-4-2	



CÓDIGO	DESCRIPCIÓN
TR0.5 XE05-4/ST	TR0.5X STACK KIT
TR0.5 XE07-6/ST	
TR0.5 XE10-9/ST	
TR0.5 XE15-11/ST	
TR0.5 XE15-13/ST	
TR0.5 XE20-17/ST	
TR0.5 XE30-19/ST	
TR0.5 XE30-21/ST	
TR0.5 XE30-23/ST	
TR0.5 XE40-25/ST	
TR1 XE05-2/ST	TR1X STACK KIT
TR1 XE07-4/ST	
TR1 XE10-5/ST	
TR1 XE15-8/ST	
TR1 XE20-11/ST	
TR1 XE30-13/ST	
TR1 XE30-15/ST	
TR1 XE30-17/ST	
TR1 XE40-21/ST	
TR1 XE55-25/ST	
TR2 XE15-4/ST	TR2X STACK KIT
TR2 XE20-5/ST	
TR2 XE30-7/ST	
TR2 XE30-9/ST	
TR2 XE40-11/ST	
TR2 XE55-14/ST	
TR2 XE55-17/ST	
TR2 XE75-22/ST	

CÓDIGO	DESCRIPCIÓN
TR3.5 XE20-2/ST	TR3.5X STACK KIT
TR3.5 XE30-3/ST	
TR3.5 XE40-5/ST	
TR3.5 XE55-6/ST	
TR3.5 XE75-9/ST	
TR3.5 XE100-12/ST	
TR3.5 XE150-15/ST	
TR3.5 XE150-17/ST	TR6X STACK KIT
TR6 XE40-2/ST	
TR6 XE55-3/ST	
TR6 XE75-4/ST	
TR6 XE100-5/ST	
TR6 XE150-6/ST	
TR6 XE150-8/ST	TR7.5X STACK KIT
TR6 XE200-10/ST	
TR6 XE250-11/ST	
TR6 XE250-12/ST	TR10X STACK KIT
TR7.5 XE55-2/ST	
TR7.5 XE75-3/ST	
TR7.5 XE100-4/ST	
TR7.5 XE150-6/ST	
TR7.5 XE200-8/ST	
TR7.5 XE250-10/ST	
TR10 XE40-1-1/ST	
TR10 XE55-1/ST	
TR10 XE75-2-2/ST	
TR10 XE100-2-1/ST	
TR10 XE100-2/ST	
TR10 XE150-4-2/ST	
TR10 XE200-5-2/ST	
TR10 XE250-5/ST	
TR10 XE250-6-2/ST	
TR10 XE250-6/ST	
TR10 XE300-7/ST	
TR10 XE400-10-2/ST	

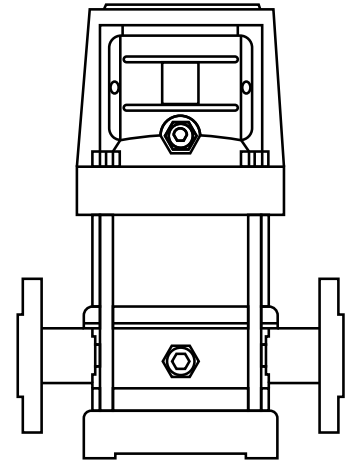



REFACCIONES
BOMBAS TRX
 SELLO MECÁNICO



MODELO DE LA BOMBA	CÓDIGO
TR0.5 XE05-4	SEMCA-TR0.6-2XE
TR0.5 XE07-6	
TR0.5 XE10-9	
TR0.5 XE15-11	
TR0.5 XE15-13	
TR0.5 XE20-17	
TR0.5 XE30-19	
TR0.5 XE30-21	
TR0.5 XE30-23	
TR0.5 XE40-25	
TR1 XE05-2	
TR1 XE07-4	
TR1 XE10-5	
TR1 XE15-8	
TR1 XE20-11	
TR1 XE30-13	
TR1 XE30-15	
TR1 XE30-17	
TR1 XE40-21	
TR1 XE55-25	
TR2 XE15-4	
TR2 XE20-5	
TR2 XE30-7	
TR2 XE30-9	
TR2 XE40-11	
TR2 XE55-14	
TR2 XE55-17	
TR2 XE75-22	

MODELO DE LA BOMBA	CÓDIGO
TR3.5 XE20-2	SEMCA-TR3.5-7.5XE
TR3.5 XE30-3	
TR3.5 XE40-5	
TR3.5 XE55-6	
TR3.5 XE75-9	
TR3.5 XE100-12	
TR3.5 XE150-15	
TR3.5 XE150-17	
TR6 XE40-2	
TR6 XE55-3	
TR6 XE75-4	
TR6 XE100-5	
TR6 XE150-6	
TR6 XE150-8	
TR6 XE200-10	
TR6 XE250-11	
TR6 XE250-12	
TR7.5 XE55-2	
TR7.5 XE75-3	
TR7.5 XE100-4	
TR7.5 XE150-6	
TR7.5 XE200-8	
TR7.5 XE250-10	
TR10 XE40-1-1	SEMCA-TR10XE
TR10 XE55-1	
TR10 XE75-2-2	
TR10 XE100-2-1	
TR10 XE100-2	
TR10 XE150-4-2	
TR10 XE200-5-2	
TR10 XE250-5	
TR10 XE250-6-2	
TR10 XE250-6	
TR10 XE300-7	
TR10 XE400-10-2	

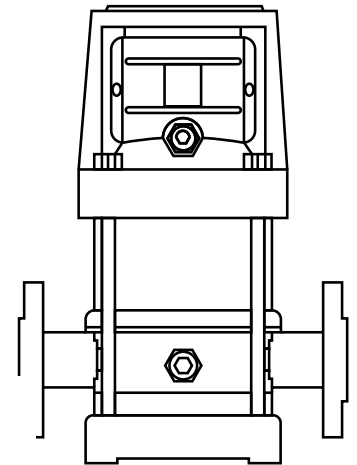



REFACCIONES MOTORES "MTR-P" (TEFC)

REFACCIÓN	MTR-P-T0.5	MTR-P-T0.75	MTR-P-T1VD	MTR-P-T1.5VD	MTR-P-T2VD	MTR-P-T3VD	MTR-P-T4VD	MTR-P-T5.5VD	MTR-P-T7.5VD	MTR-P-T10VD	MTR-P-T15VD	MTR-P-T20VD	MTR-P-T25VD	MTR-P-T30VD	MTR-P-T40VD	MTR-P-T50VD	MTR-P-T60VD	MTR-P-T75VD	MTR-P-T100VD	CÓDIGO
CAJA DE CONEXIONES	√	√																		R-MTR-CCONEX-A
			√	√	√	√														R-MTR-CCONEX-B
									√	√	√									R-MTR-CCONEX-E
												√	√							R-MTR-CCONEX-G
															√					R-MTR-CCONEX-H
																√	√			R-MTR-CCONEX-I
																		√		R-MTR-CCONEX-J
																			√	R-MTR-CCONEX-K
TAPA DE VENTILADOR	√	√																		R-MTR-TVENT-A
			√	√																R-MTR-TVENT-B
					√	√														R-MTR-TVENT-C
							√													R-MTR-TVENT-D
								√												R-MTR-TVENT-E
									√	√										R-MTR-TVENT-F
											√	√	√							R-MTR-TVENT-G
															√					R-MTR-TVENT-H
																√	√			R-MTR-TVENT-I
																		√		R-MTR-TVENT-J
																			√	R-MTR-TVENT-K
																			√	R-MTR-TVENT-L
VENTILADOR	√	√																		R-MTR-VENT-A
			√	√																R-MTR-VENT-B
					√	√														R-MTR-VENT-C
							√	√												R-MTR-VENT-D
									√	√										R-MTR-VENT-F
											√	√	√							R-MTR-VENT-G
															√	√				R-MTR-VENT-H
																	√			R-MTR-VENT-I
																		√		R-MTR-VENT-J
																			√	R-MTR-VENT-K
																			√	R-MTR-VENT-L
	TERMINAL DE CONEXIONES	√	√																	
			√	√	√	√														R-MTR-TCONEX-B
								√	√	√										R-MTR-TCONEX-E
											√	√	√							R-MTR-TCONEX-G
															√					R-MTR-TCONEX-H
																√	√	√		R-MTR-TCONEX-I
																		√	√	R-MTR-TCONEX-J
BALEROS	√	√																		R-MTR-BALERO-6202
			√	√																R-MTR-BALERO-6204
					√	√														R-MTR-BALERO-6205
							√													R-MTR-BALERO-6206
								√												R-MTR-BALERO-6306
									√	√										R-MTR-BALERO-6308
											√	√	√							R-MTR-BALERO-7309
												√	√	√						R-MTR-BALERO-6209
															√					R-MTR-BALERO-7311
																√				R-MTR-BALERO-6211
																√	√			R-MTR-BALERO-7212
																				R-MTR-BALERO-6212
																				R-MTR-BALERO-6212B
																	√			R-MTR-BALERO-7312
																		√		R-MTR-BALERO-6312
																			√	R-MTR-BALERO-7313
																			√	R-MTR-BALERO-6313
																		√	R-MTR-BALERO-7314	
																		√	R-MTR-BALERO-6314	

REFACCIÓN	MSX6 7.53230	MSX6 7.53460	MSX6 103230	MSX6 103460	MSX6 153230	MSX6 153460	MSX6 203460	MSX6 203230	MSX6 253230	MSX6 253460	MSX6 303230	MSX6 303460	MSX6 403230	MSX6 403460	MSX6 503230	MSX6 503460	CÓDIGO
CABLE CONECTOR	✓	✓	✓	✓	✓	✓	✓	✓	✓	✓	✓	✓	✓	✓	✓	✓	R-MSXCC6MM2
																	R-MSXCC10MM2
																	R-MSXCC16MM2
KIT DE BUJUE	✓	✓	✓	✓	✓	✓	✓	✓	✓	✓	✓	✓	✓	✓	✓	✓	R-MSXBUE7.5/20
																	R-MSXBUE25
																	R-MSXBUE30/50
CONJUNTO DE EMPUJE	✓	✓	✓	✓	✓	✓	✓	✓	✓	✓	✓	✓	✓	✓	✓	✓	R-MSXCE7.5/25
																	R-MSXCE30/50
DIAFRAGMA	✓	✓	✓	✓	✓	✓	✓	✓	✓	✓	✓	✓	✓	✓	✓	✓	R-MSXDIAF6"
SET DE TORNILLOS	✓	✓	✓	✓	✓	✓	✓	✓	✓	✓	✓	✓	✓	✓	✓	✓	R-MSXTORN6"
SELLO MECÁNICO	✓	✓	✓	✓	✓	✓	✓	✓	✓	✓	✓	✓	✓	✓	✓	✓	R-MSXSELLOMEC6"
SOPORTE SUPERIOR	✓	✓	✓	✓	✓	✓	✓	✓	✓	✓	✓	✓	✓	✓	✓	✓	R-MSXSSUP6"
BRIDA P/MOTOR	✓	✓	✓	✓	✓	✓	✓	✓	✓	✓	✓	✓	✓	✓	✓	✓	R-MSXBRIDA6"
ALTAMIRA-X 6" SOPORTE INFERIOR	✓	✓	✓	✓	✓	✓	✓	✓	✓	✓	✓	✓	✓	✓	✓	✓	R-MSXSINF7.5/25
																	R-MSXSINF30/50
CAJA DE AJUSTE	✓	✓	✓	✓	✓	✓	✓	✓	✓	✓	✓	✓	✓	✓	✓	✓	R-MSXCA6"
BASE	✓	✓	✓	✓	✓	✓	✓	✓	✓	✓	✓	✓	✓	✓	✓	✓	R-MSXBASE6"
SENSOR DE TEMP. PT100 PMSX	✓	✓	✓	✓	✓	✓	✓	✓	✓	✓	✓	✓	✓	✓	✓	✓	PT-100-MSX



ALTAMIRA®

REFACCIONES

MOTORES SERIE "X" DE 8" Y 10"

REFACCIÓN	MSX8/6 603460	MSX8 753460	MSX8 1003460	MSX10/8 1253460	MSX10/8 1503460	MSX10/8 1753460	MSX10/8 2003460	CÓDIGO
CABLE CONECTOR	√							R-MSXCC16MM2
		√	√					R-MSXCC25MM2
				√	√	√	√	R-MSXCC35MM2
KIT BUJE	√	√	√					R-MSXBUJE8"
				√	√	√	√	R-MSXBUJE10"
CONJUNTO DE EMPUJE	√							R-MSXCE60
		√	√					R-MSXCE8"
				√	√	√	√	R-MSXCE10"
DIAFRAGMA	√	√	√					R-MSXDIAF8"
				√	√	√	√	R-MSXDIAF10"
SET DE TORNILLO	√	√	√					R-MSXTORN8"
				√	√	√	√	R-MSXTORN10"
SELLO MECÁNICO	√	√	√					R-MSXSELLOME8"
				√	√	√	√	R-MSXSELLOME10"
SOPORTE SUPERIOR	√	√	√					R-MSXSSUP8"
				√	√	√	√	R-MSXSSUP10"
BRIDA DE ACOPLAM.	√							R-MSXBRIDA8/6"
		√	√					R-MSXBRIDA8"
SOPORTE INFERIOR	√	√	√					R-MSXSINF8"
				√	√	√	√	R-MSXSINF10"
CAJA DE AJUSTE	√	√	√					R-MSXCA8"
				√	√	√	√	R-MSXCA10"
BASE	√	√	√					R-MSXBASE8"
				√	√	√	√	R-MSXBASE10"

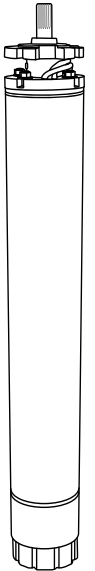

ALTAMIRA®

REFACCIONES BOMBAS GRD

REFACCIÓN	GRD1.5-10-1127A	GRD1.5-10-1220A	GRD1.5-15-1220A	GRD1.5-20-3230	GRD1.5-30-3230	GRD1.5-30-3460	GRD2-50-3230	GRD2-50-3460	GRD2-75-3230	GRD2-75-3460	CÓDIGO
CONECTOR MANGUERA	√	√	√	√	√	√					R-GRD1.5-CONM
							√	√	√	√	R-GRD2-CONM
ASA GRD	√	√	√								R-GRD1.5-10/15-ASA
BASE PARA CONECTOR				√	√	√					R-GRD1.5-20/30-BCO
							√	√			R-GRD1.5-30-BCON
									√	√	R-GRD2-50/75-BCON
TAPA SUPERIOR	√	√	√								R-GRD1.5-10/15-TSU
				√	√	√					R-GRD1.5-20/30-TSU
							√	√			R-GRD2-50-TAPASUP
CUERPO DE BOMBA									√	√	R-GRD2-75-TAPASUP
	√	√	√								R-GRD1.5-10/15-CB
				√	√	√					R-GRD1.5-20/30-CB
							√	√	√	√	R-GRD2-50/75-CB
IMPULSOR	√	√									R-GRD1.5/10-IMP
			√								R-GRD1.5/15-IMP
				√							R-GRD1.5/20-IMP
					√	√					R-GRD1.5/30-IMP
							√	√			R-GRD2/50-IMP
									√	√	R-GRD2/75-IMP
SISTEMA DE CORTE	√	√	√								R-GRD1.5-10/15-SC
				√	√	√					R-GRD1.5-20/30-SC
							√	√	√	√	R-GRD2-50/75-SC
BALERO SUPERIOR	√	√	√								R-GRD1.5-10/15-BSU
				√							R-GRD1.5/20-BALSUP
					√	√					R-GRD1.5/30-BALSUP
							√	√			R-GRD2/50-BALSUP
									√	√	R-GRD2/75-BALSUP
BALERO INFERIOR	√	√	√								R-GRD1.5-10/15-BIN
				√							R-GRD1.5/20-BALINF
					√	√					R-GRD1.5/30-BALINF
							√	√			R-GRD2/50-BALINF
								√	√	R-GRD2/75-BALINF	
CAPACITOR 250UF	√										R-GRD1.5/10-CAP250
CAPACITOR 150UF		√	√								R-GRD1.5/15-CAP150
CAPACITOR 45UF	√										R-GRD1.5/10-CAP45
RELÉ	√	√									R-GRD1.5/10-RELE
			√								R-GRD1.5/15-RELE
				√							R-GRD1.5/20-RELE
					√	√					R-GRD1.5/30-RELE
							√	√			R-GRD2/50-RELE
									√	√	R-GRD2/75-RELE
SELLO MECÁNICO	√	√	√								R-GRD1.5-10/15-SM
				√	√	√					R-GRD1.5-20/30-SM
							√	√	√	√	R-GRD2-50/75-SM
RETÉN	√	√	√								R-GRD1.5-10/15-RET
				√	√	√					R-GRD1.5-20/30-RET
							√	√	√	√	R-GRD2-50/75-RET
EMPAQUE 36A	√	√									R-GRD1.5/10-E36A
			√								R-GRD1.5/15-E36A
				√							R-GRD1.5/20-E36A
					√	√					R-GRD1.5/30-E36A
							√	√			R-GRD2/50-E36A
									√	√	R-GRD2/75-E36A

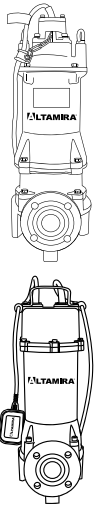

REFACCIÓN	GRD1.5-10-1127A	GRD1.5-10-1220A	GRD1.5-15-1220A	GRD1.5-20-3230	GRD1.5-30-3230	GRD1.5-30-3460	GRD2-50-3230	GRD2-50-3460	GRD2-75-3230	GRD2-75-3460	CÓDIGO
EMPAQUE 36B	√	√									R-GRD1.5/10-E36B
			√								R-GRD1.5/15-E36B
				√							R-GRD1.5/20-E36B
					√	√					R-GRD1.5/30-E36B
							√	√			R-GRD2/50-E36B
									√	√	R-GRD2/75-E36B
EMPAQUE 36C	√	√									R-GRD1.5/10-E36C
			√								R-GRD1.5/15-E36C
				√							R-GRD1.5/20-E36C
					√	√					R-GRD1.5/30-E36C
							√	√			R-GRD2/50-E36C
									√	√	R-GRD2/75-E36C
EMPAQUE 36D	√	√									R-GRD1.5/10-E36D
			√								R-GRD1.5/15-E36D
				√							R-GRD1.5/20-E36D
					√	√					R-GRD1.5/30-E36D
							√	√			R-GRD2/50-E36D
									√	√	R-GRD2/75-E36D
EMPAQUE 36E				√							R-GRD1.5/20-E36E
					√	√					R-GRD1.5/30-E36E
							√	√			R-GRD2/50-E36E
									√	√	R-GRD2/75-E36E
EMPAQUE TAPA SUPERIOR	√	√	√							R-GRD1.5-10/15-OTS	
EMPAQUE DESCARGA	√	√	√	√	√	√				R-GRD1.5/10-30-EMP	
BUJE DE FLECHA				√	√	√					R-GRD2/50-75/EMP
							√	√	√	√	R-GRD1.5-20/30-BFL
PLACA DE FIJACIÓN				√							R-GRD2-50/75-BFL
	√	√	√								R-GRD1.5-10/15-PFJ
				√							R-GRD1.5-20-PFJ
					√	√					R-GRD1.5-30-PFJ
DISTANCIADOR				√	√	√					R-GRD2-50/75-PFJ
							√	√	√	√	R-GRD1.5-20/30-DIS
TORNILLO 42E	√	√	√							R-GRD2-50/75-DIS	
TORNILLO 42G				√	√	√	√	√	√	√	R-GRD1.5-10/15-TOR
TUERCA				√	√	√	√	√	√	√	R-GRD2-20/75-TOR
ARANDELA 44B	√	√	√								R-GRD1.5-10/15-TUE
ARANDELA ONDULADA 44C	√	√	√								R-GRD1.5-10/15-ARB
				√	√	√					R-GRD1.5-10/15-ARC
							√	√			R-GRD1.5-20/30-ARC
									√	√	R-GRD2-50-AOND44C
CUÑA				√	√	√					R-GRD2-75-AOND44C
	√	√	√								R-GRD1.5-10/15-CUÑ
				√	√	√					R-GRD1.5-20/30-CUÑ
CANDADO							√	√	√	√	R-GRD2-50/75-CUÑA
	√	√	√								R-GRD1.5-10/15-CAN
				√	√	√					R-GRD1.5-20/30-CAN
							√	√			R-GRD2-50-CAN
CABLE 10M									√	√	R-GRD2-75-CAN
	√										R-GRD1.5-10-CC
		√	√								R-GRD1.5-10/15-CC
				√	√						R-GRD1.5-20/30-CC
						√					R-GRD1.5/30-CC
							√	√			R-GRD2/50-CC
INTERRUPTOR ELÉCTRICO								√	√	R-GRD2/75-CC	
FLOTADOR (16/8A)	√	√	√								R-GRD1.5-10/15-INT
FLOTADOR (10/4A)	√										R-GRD1.5/10-FLOTAD
		√	√								R-GRD1.5/15-FLOTAD

ALTAMIRA® REFACCIONES

BOMBAS STRONG

REFACCIÓN	STRONG 1.5/05/ 1127A	STRONG2/ 10/1230	STRONG2/ 20/1230	STRONG3/ 20/3234	STRONG3/ 40/3234	STRONG4/ 50/3234	CÓDIGO
SELLO MECÁNICO	√						R-STRG1.5-SELLOM
IMPULSOR	√						R-STRG1.5/05-IMP
CAPACITOR	√						R-STRG1.5/05-C12UF
O-RING	√						R-STRG1.5-ORINGP18
	√						R-STRG1.5-ORINGP25
EJE DE PLASTICO PARA FLOTADOR R-STRG1.5	√						R-STRG1.5/EJEFLOT
SUJETADOR DE GOMA	√						R-STRG1.5/SUGO
PARA EJE DE PLASTICO IMPULSOR2/20		√					R-STR2/10-IMP
SELLO MECÁNICO		√	√				R-STR2-SELLOM
VOLUTA		√	√				R-STRG2-VOLUTA
EMPAQUE DE VOLUTA		√	√				R-STRG2-EVOLUTA
EMPAQUE DE BRIDA		√	√				R-STRG2-EMPQUEB
BRIDA		√	√				R-STRG2-BRIDA
TAPA PORTA SELLO		√	√				R-STRG2-TPORTAS
JUNTA TORICA TAPA PORTA SELLO		√	√				R-STRG2-JTORICAS
BALEROS		√	√				R-STRG2-BALERO
TAPA DEL MOTOR		√	√				R-STRG2-TMOTOR
CAPACITOR		√	√				R-STRG2-CAP30UF
ADAPTADOR DE CONECTOR		√	√				R-STRG2-ACONECTOR
JUNTA TORICA CONECTOR		√	√				R-STRG2-JTORICAC
CABLE CONECTOR		√	√				R-STRG2-CONECTOR
VOLUTA				√			R-STRG3/20-VOLUTA
					√		R-STRG3/40-VOLUTA
IMPULSOR				√			R-STR3/20-IMP
					√		R-STR3/40-IMP
EMPAQUE DE VOLUTA				√	√		R-STRG3-EVOLUTA
TAPA PORTA SELLO				√	√		R-STRG3-TPORTAS
SELLO MECÁNICO				√	√		R-STR3-SELLOM
BALERO				√	√		R-STRG3-BALERO
CABLE CONECTOR				√	√		R-STRG3-CONECTOR
EMPAQUE DE CONECTOR				√	√		R-STRG3-EMPC
TAPA DE CONECTOR				√	√		R-STRG3-TCONECTOR
EMPAQUE DE TAPA DE CONECTOR					√	√	R-STRG3-ETCONEC
JUNTA TÓRICA MOTOR				√	√		R-STRG3-JTORICAM



REFACCIÓN	STRONG4/ 50/3234	STRONG4/ 75/3234	STRONG4/ 100/3234	STRONG4/ 150/3234	CÓDIGO
VOLUTA	√				R-STRG4/50-VOLUTA
EMPAQUE DE VOLUTA	√				R-STRG4/50-EVOLUTA
IMPULSOR	√				R-STR4/50-IMP
SELLO MECÁNICO	√				R-STR4/50-SELLOM
EMP. TAPA PORTASELLO	√	√			R-STRG4/50-ETPORTS
ANILLO RETENEDOR	√				R-STRG4/50-ARETEN
EMPAQUES DE MOTOR	√				R-STRG4/50-EMOTOM
BALERO INFERIOR	√				R-STRG4/50-BALINF
BALERO SUPERIOR	√				R-STRG4/50-BALSUP
EMPAQUE DE CONECTOR	√				R-STRG4/50-EMPC
CABLE CONECTOR	√				R-STRG4/50-CONECT
VOLUTA		√	√	√	R-STRG4/715-VOLUTA
EMPAQUE DE VOLUTA		√	√	√	R-STRG4/715-EVOLUT
IMPULSOR		√			R-STR4/75-IMP
			√		R-STR4/100-IMP
			√		R-STR4/150-IMP
SELLO MÉCANICO		√	√	√	R-STR4/715-SELLOM
EMPAQUES PARA TAPA		√	√	√	R-STRG4/715-ETPORS
PORTASELLO Y MOTOR		√	√	√	R-STRG4/715-ARETEN
BALERO INFERIOR		√	√	√	R-STRG4/715-BALINF
BALERO SUPERIOR		√	√	√	R-STRG4/715-BALSUP
EMPAQUE DE CONECTOR		√	√	√	R-STRG4/715-EMPC
CABLE CONECTOR		√			R-STRG4/75-CONECT
			√		R-STRG4/100-CONECT
				√	R-STRG4/150-CONECT



REFACCIÓN	TANTUM3-50-3230	TANTUM3-50-3460	TANTUM4-75-3230	TANTUM4-75-3460	TANTUM6-100-3230	TANTUM6-100-3460	CÓDIGO
ADAPTADOR ESPIGA PARA MANGUERA	√	√					R-TANT3-AD-MANG
			√	√			R-TANTUM4-AD-MANG
AGITADOR	√	√	√	√	√	√	R-TANTUM6-AD-MANG
							R-TANT3-4-6-AGITAD
ARANDELA	√	√					R-TANT3-4-ARAN-44H
			√	√	√	√	R-TANT4-6-ARAN-44B
			√	√	√	√	R-TANT4-6-ARAN-44H
BALERO	√	√					R-TIDE2-BAL-31B
	√	√					R-FOSS-BAL-6308
			√	√			R-TANT4-BAL-6306
			√	√			R-TANT4-BAL-6309
					√	√	R-TIDE3-50-BAL-31B
					√	√	R-TANT6-BAL-3310
BASE DE BALERO	√	√					R-TANT3-BASE-BAL
			√	√			R-TANT4-BASE-BAL
					√	√	R-TANT6-BASE-BAL
BASE SELLO MECÁNICO	√	√	√	√	√	√	R-TANT3-BASE-SM
CABLE DE ALIMENTACIÓN	√	√					R-TANT3-CABLE
			√	√			R-TANT4-CABLE
					√	√	R-TANT6-CABLE
CANDADO	√	√					R-TANT3-CAND-46
			√	√			R-TANT4-CANDADO-46
					√	√	R-TANT6-CANDADO-46
COLADOR	√	√					R-TANT3-COLADOR
			√	√			R-TANT4-COLADOR
					√	√	R-TANT6-COLADOR
CUÑA DE ROTOR	√	√					R-FOSS3-4-CUÑA
			√	√	√	√	R-TANT4-6-CUÑA
DISTANCIADOR	√	√					R-TANT3-DIST-38
			√	√	√	√	R-TANT4-6-DIST-38
IMPULSOR	√	√					R-TANT3-IMP
			√	√			R-TANT4-IMP
					√	√	R-TANT6-IMP
O-RING O JUNTA TORICA	√	√					R-TANT3-ORING36B
			√	√	√	√	R-TANT4-6-ORING36C
	√	√					R-TANT3-ORING36D
	√	√					R-TANT3-ORING36E
			√	√	√	√	R-TANT4-6-ORING36E
	√	√					R-TANT3-JUNTA37A
			√	√	√	√	R-TANT4-6-JUNTA37A
	√	√					R-TANT3-JUNTA37B
			√	√	√	√	R-TANT4-6-JUNTA37B
√	√					R-TANT3-JUNTA37C	
		√	√	√	√	R-TANT4-6-JUNTA37C	
PLACA PROTECTORA	√	√					R-TANT3-P-PROTE
			√	√			R-TANT4-P-PROTE
SELLO DE ACEITE	√	√					R-FOSS3-SELLO-ACE
			√	√	√	√	R-TANT4-SELLO-ACE
SELLO MECÁNICO	√	√					R-FOSS3-SM
			√	√	√	√	R-TANT4-SM



REFACCIÓN	FOSS3 -30-3230	FOSS3 -30-3460	FOSS4 -50-3230	FOSS4 -50-3460	CÓDIGO
ADAPTADOR ESPIGA PARA MANGUERA	√	√			R-FOSS3-AD-MANG
			√	√	R-FOSS4-AD-MANG
IMPULSOR	√	√			R-FOSS3-IMP
			√	√	R-FOSS4-IMP
AGITADOR	√	√	√	√	R-FOSS-AGITAD
COLADOR	√	√	√	√	R-FOSS-COLADOR
BALERO			√	√	R-FOSS-BAL-6308
	√	√			R-TIDE3-50-BAL-31B
	√	√	√	√	R-TIDE2-BAL-31b
CLIXON	√	√			R-FOSS3-PRO-T
			√	√	R-FOSS4-PRO-T
SELLO MECANICO	√	√	√	√	R-FOSS3-SM
SELLO DE ACEITE	√	√			R-FOSS3-SELLO-ACE
O-RING O JUNTA TORICA	√	√	√	√	R-FOSS-ORING36B
	√	√	√	√	R-FOSS-ORING36D
	√	√	√	√	R-FOSS-ORING36F
	√	√	√	√	R-FOSS-ORING36G
	√	√	√	√	R-FOSS-JUNTA37C
BUJE	√	√	√	√	R-FOSS3-4-BUJE
BASE DE BALERO	√	√	√	√	R-FOSS-BASE-BAL
BASE SELLO MECANICO	√	√	√	√	R-FOSS-BASE-SM
ARANDELA	√	√	√	√	R-FOSS3-4-ARAN-44D
	√	√	√	√	R-FOSS3-4-ARAN-44F
	√	√	√	√	R-FOSS3-4-ARAN-44C
	√	√	√	√	R-FOSS3-4-ARAN-44K
CUÑA DE ROTOR	√	√	√	√	R-FOSS3-4-CUÑA
CABLE DE ALIMENTACION	√	√	√	√	R-FOSS-CABLE
O-RING O JUNTA TORICA	√	√	√	√	R-TIDE2-ORING36A
	√	√	√	√	R-TIDE2-ORING36B
PLACA PROTECTORA	√	√	√	√	R-TIDE3-50-P-PROTE
O-RING O JUNTA TORICA	√	√	√	√	R-TIDE3-JUNTA 37A
TORNILLO	√	√	√	√	R-TIDE3-SCREW-42E
CANDADO	√	√	√	√	R-TIDE3-CAND-46



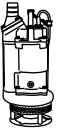

REFACCIÓN	TIDE2 -20-3230	TIDE2 -30-3230	TIDE3 -50-3230	TIDE3 -50-3460	TIDE4 -50-3230	TIDE4 -50-3460	CÓDIGO
ADAPTADOR MANGUERA	√	√					R-TIDE2-20-AD-MANG
			√	√			R-TIDE3-50-AD-MANG
					√	√	R-TIDE4-50-AD-MANG
AGITADOR	√	√					R-TIDE2-20-AGITAD
			√	√	√	√	R-TIDE3-50-AGITAD
ARANDELA	√	√					R-TIDE2-ARAND-44F
	√	√					R-TIDE2-ARAND-44H
			√	√	√	√	R-TIDE3-ARAND-44D
BALERO	√	√					R-TIDE2-20-BAL-31A
	√	√					R-TIDE2-BAL-31B
			√	√	√	√	R-TIDE3-50-BAL-31A
			√	√	√	√	R-TIDE3-50-BAL-31B
BASE DE SELLO MECANICO	√	√					R-TIDE2-BASE-SM
			√	√	√	√	R-TIDE3-BASE-SM
CABLE CONECTOR	√	√					R-TIDE2-CABLE
			√	√	√	√	R-TIDE3-CABLE
CANDADO	√	√					R-TIDE2-CAND-46A
	√	√					R-TIDE2-CAND-46B
			√	√	√	√	R-TIDE3-CAND-46
	√	√					R-TIDE2-20-COL
			√	√	√	√	R-TIDE3-50-COL
CUÑA DE ROTOR	√	√					R-TIDE2-CUÑA
			√	√	√	√	R-TIDE3-CUÑA
DISTANCIADOR	√	√					R-TIDE2-DIST-38
IMPULSOR	√						R-TIDE2-20-IMP
		√					R-TIDE2-30-IMP
			√	√			R-TIDE3-50-IMP
					√	√	R-TIDE4-50-IMP
O-RING O JUNTA TORICA			√	√	√	√	R-TIDE3-JUNTA 37A
	√	√					R-TIDE2-JUNTA 37A
			√	√	√	√	R-TIDE3-JUNTA 37B
	√	√					R-TIDE2-JUNTA 37B
	√	√					R-TIDE2-JUNTA 37C
			√	√	√	√	R-TIDE3-JUNTA 37C
			√	√	√	√	R-TIDE3-JUNTA 37D
			√	√	√	√	R-TIDE3-ORING36B
	√	√					R-TIDE2-ORING36C
			√	√	√	√	R-TIDE3-ORING36C
			√	√	√	√	R-TIDE3-ORING36D
	√	√					R-TIDE2-ORING36D
			√	√	√	√	R-TIDE3-ORING36E
√	√	√	√	√	√	R-TIDE2-ORING36A	
√	√					R-TIDE2-ORING36B	
PLACA PROTECTORA			√	√			R-TIDE3-50-P-PROTE
	√	√					R-TIDE2-20-P-PROTE
SELLO DE ACEITE			√	√	√	√	R-TIDE3-SELLO-ACE
	√	√					R-TIDE2-SELLO-ACE
SELLO MECANICO			√	√	√	√	R-TIDE3-SELLO-MEC
	√	√					R-TIDE2-SELLO-MEC
TAPON DE DRENADO GENERAL	√	√	√	√	√	√	R-TIDE3-SCREW-42E

ALTAMIRA® REFACCIONES

BOMBAS COBÁ

REFACCIÓN	COBA4/75/3230	COBA4/100/3230	COBA6/75/3230	CÓDIGO
CONECTOR MANGUERA COBA4	√	√		R-COB4 CONM
CONECTOR MANGUERA COBA6			√	R-COB6 CONM
IMPULSOR	√			R-COBA4/75-IMP
		√		R-COBA4/100-IMP
			√	R-COBA6/75-IMP
BALERO SUPERIOR COBA4&6/75	√		√	R-COBA4-6/75-BSUP
BALERO SUPERIOR COBA/100		√		R-COBA4/100-BSUP
BALERO INFERIOR COBA4&6/75	√		√	R-COBA4-6/75-BINF
BALERO INFERIOR COBA4/100		√		R-COBA4/100-BINF
SELLO MECANICO COBA4&6/75	√		√	R-COBA4-6/75-SELM
SELLO MECANICO COBA4/100		√		R-COBA4/100-SELM
EMPAQUES 36A COBA4&6/75	√		√	R-COBA4-6/75-E36A
EMPAQUES 36A COBA4/100		√		R-COBA4/100-EQ36A
EMPAQUES 36B COBA4&6/75	√		√	R-COBA4-6/75-E36B
EMPAQUES 36B COBA4/100		√		R-COBA4/100-EQ36B
EMPAQUES 36C COBA4&6/75	√		√	R-COBA4-6/75-E36C
EMPAQUES 36C COBA4/100		√		R-COBA4/100-E36C
EMPAQUES 36D COBA4&6/75	√		√	R-COBA4-6/75-E36D
EMPAQUES 36D COBA4/100		√		R-COBA4/100-E36D
EMPAQUES 36E COBA4&6/75	√		√	R-COBA4-6/75-E36E
EMPAQUES 36E COBA4/100		√		R-COBA4/100-E36E
JUNTA TORICA COBA4/75	√			R-COBA4/75-JTORICA
JUNTA TORICA COBA6/75		√		R-COBA6/75-JTORICA
JUNTA TORICA COBA4/100			√	R-COBA4/100-JTORIC
DISTANCIADOR 41A COBA4&6/75	√		√	R-COBA4-6/75-D41A
DISTANCIADOR 41A COBA4/100		√		R-COBA4/100-D41A
CUÑA COBA4&6/75	√		√	R-COBA4-6/75-CUÑA
CUÑA COBA4/100		√		R-COBA4/100-CUÑA
47X CONECTOR 10M COBA4&6/75	√		√	R-COBA4-6/75-CON

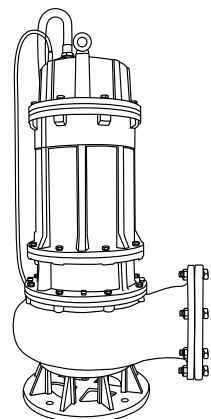

REFACCIÓN	COBA4/ 150/3230	COBA6/ 150/3230	COBA8/ 150/3230	COBA8/ 150/3460	CÓDIGO
CONECTOR MANGUERA COBA4	√				R-COB4 CONM
CONECTOR MANGUERA COBA6		√			R-COB6 CONM
CONECTOR MANGUERA COBA8			√	√	R-COB8 CONM
IMPULSOR	√				R-COBA4/150-IMP
		√			R-COBA6/150-IMP
			√	√	R-COBA8/150-IMP
BALERO SUP. COBA4/6/8 DE 15HP	√	√	√	√	R-COBA468/150-BSUP
BALERO INF. COBA4/6/8 DE 15HP	√	√	√	√	R-COBA468/150-BINF
SELLO MEC. COBA4/6/8 DE 15HP	√	√	√	√	R-COBA468/150-SELM
EMP. 36A COBA4/6/8 DE 15HP	√	√	√	√	R-COBA468/150-E36A
EMP. 36B COBA4/6/8 DE 15HP	√	√	√	√	R-COBA468/150-E36B
EMP. 36D COBA4/6/8 DE 15HP	√	√	√	√	R-COBA468/150-E36D
EMP. 36E COBA4/6/8 DE 15HP	√	√	√	√	R-COBA468/150-E36E
EMP. 36G COBA4/6/8 DE 15HP	√	√	√	√	R-COBA468/150-E36G
JUNTA TORICA COBA4/150	√				R-COBA4/150-JTORIC
JUNTA TORICA COBA6/150		√			R-COBA6/150-JTORIC
JUNTA TORICA COBA8/150			√	√	R-COBA8/150-JTORIC
DISTANCIADOR 41B COBA4/6/8 15HP	√	√	√	√	R-COBA468/150-D41B
DISTANCIADOR 41C COBA4/6/8 15HP	√	√	√	√	R-COBA468/150-D41C
TORNILLO 42F COBA4/6/8 DE 15HP	√	√	√	√	R-COBA468/150-T42F
CUÑA COBA4/6/8 15HP	√	√	√	√	R-COBA468/150-CUÑA
CONECT. 10M COBA4/6/8 15HP 230V	√	√	√		R-COBA468/150-CO23
CONECT. 10M COBA4/6/8 15HP 460V				√	R-COBA468/150-CO43

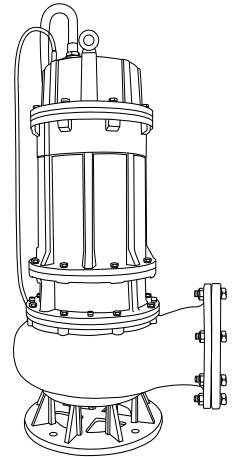

REFACCIÓN	COBA4/ 200/3230	COBA4/ 200/3460	COBA8/ 200/3230	COBA8/ 200/3460	CÓDIGO
CONECTOR MANGUERA COBA4	√	√			R-COB4 CONM
CONECTOR MANGUERA COBA8			√	√	R-COB8 CONM
IMPULSOR	√	√			R-COBA4/200-IMP
			√	√	R-COBA8/200-IMP
BALERO SUP. COBA4/6/8 20HP	√	√	√	√	R-COBA468/200-BSUP
BALERO INF. COBA4/6/8 20HP	√	√	√	√	R-COBA468/200-BINF
SELLO MECANICO COBA4/6/8 20HP	√	√	√	√	R-COBA468/200-SELM
EMPAQUES 36A COBA4/6/8 20HP	√	√	√	√	R-COBA468/200-E36A
EMPAQUES 36B COBA4/6/8 20HP	√	√	√	√	R-COBA468/200-E36B
EMPAQUES 36D COBA4/6/8 20HP	√	√	√	√	R-COBA468/200-E36D
EMPAQUES 36E COBA4/6/8 20HP	√	√	√	√	R-COBA468/200-E36E
EMPAQUES 36G COBA4/6/8 20HP	√	√	√	√	R-COBA468/200-E36G
JUNTA TORICA COBA4/200	√	√			R-COBA4/200-JTORIC
JUNTA TORICA COBA8/200			√	√	R-COBA8/200-JTORIC
DISTANCIADOR 41B COBA4/6/8 20HP	√	√	√	√	R-COBA468/200-D41B
DISTANCIADOR 41C COBA4/6/8 20HP	√	√	√	√	R-COBA468/200-D41C
TORNILLO 42F COBA4/6/8 20HP	√	√	√	√	R-COBA468/200-T42F
CUÑA COBA4/6/8 20HP	√	√	√	√	R-COBA468/200-CUÑA
CONEC. 10M COBA4/6/8 20HP 230V	√		√		R-COBA468/200-CO23
CONEC. 10M COBA4/6/8 20HP 460V		√		√	R-COBA468/200-CO43

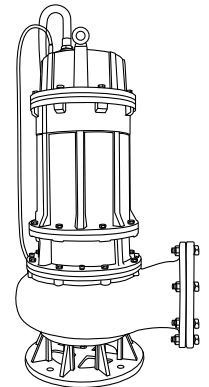

REFACCIÓN	COBA8/250/3230	COBA8/250/3460	CÓDIGO
CONECTOR MANGUERA COBA8	√	√	R-COB8 CONM
IMPULSOR	√	√	R-COBA8/250-IMP
BALERO SUPERIOR COBA8 DE 25HP	√	√	R-COBA8/250-BALSUP
BALERO INFERIOR COBA8 DE 25HP	√	√	R-COBA8/250-BALINF
SELLO MECANICO COBA8 DE 25HP	√	√	R-COBA8/250-SELLM
EMPAQUES 36A COBA8 DE 25HP	√	√	R-COBA8/250-E36A
EMPAQUES 36B COBA8 DE 25HP	√	√	R-COBA8/250-E36B
EMPAQUES 36D COBA8 DE 25HP	√	√	R-COBA8/250-E36D
EMPAQUES 36E COBA8 DE 25HP	√	√	R-COBA8/250-E36E
EMPAQUES 36G COBA8 DE 25HP	√	√	R-COBA8/250-E36G
JUNTA TORICA COBA8 25HP	√	√	R-COBA8/250-JTORIC
DISTANCIADOR 41B COBA8 DE 25HP	√	√	R-COBA8/250-D41B
DISTANCIADOR 41C COBA8 DE 25HP	√	√	R-COBA8/250-D41C
TORNILLO 42F COBA8 DE 25HP	√	√	R-COBA8/250-T42F
CUÑA COBA8 25HP	√	√	R-COBA8/250-CUÑA
CONECTOR 10M COBA8 DE 25HP 230V	√		R-COBA8/250-CON23
CONECTOR 10M COBA8 DE 25HP 460V		√	R-COBA8/250-CON43

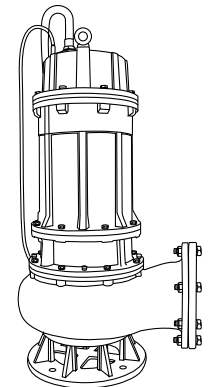

REFACCIÓN	COBA6/300/3460	COBA8/300/3460	CÓDIGO
CONECTOR MANGUERA COBA6	√		R-COB6 CONM
CONECTOR MANGUERA COBA8		√	R-COB8 CONM
IMPULSOR	√		R-COBA6/300-IMP
		√	R-COBA8/300-IMP
BALERO SUPERIOR COBA6/8 DE 30HP	√	√	R-COBA6/8/300-BSUP
BALERO INFERIOR COBA6/8 DE 30HP	√	√	R-COBA6/8/300-BINF
SELLO MECANICO COBA6/8 DE 30HP	√	√	R-COBA6/8/300-SELM
EMPAQUES 36A COBA6/8 DE 30HP	√	√	R-COBA6/8/300-E36A
EMPAQUES 36B COBA6/8 DE 30HP	√	√	R-COBA6/8/300-E36B
EMPAQUES 36D COBA6/8 DE 30HP	√	√	R-COBA6/8/300-E36D
EMPAQUES 36E COBA6/8 DE 30HP	√	√	R-COBA6/8/300-E36E
EMPAQUES 36G COBA6/8 DE 30HP	√	√	R-COBA6/8/300-E36G
JUNTA TORICA COBA6 30HP	√		R-COBA6/300-JTORIC
JUNTA TORICA COBA8 30HP		√	R-COBA8/300-JTORIC
DISTANCIADOR 41B COBA6/8 DE 30HP	√	√	R-COBA6/8/300-D41B
DISTANCIADOR 41C COBA6/8 DE 30HP	√	√	R-COBA6/8/300-D41C
TORNILLO 42F COBA6/8 DE 30HP	√	√	R-COBA6/8/300-T42F
CUÑA COBA6/8 30HP	√	√	R-COBA6/8/300-CUÑA
CONECTOR 10M COBA6/8 DE 30HP 460V	√	√	R-COBA6/8/300-CO43

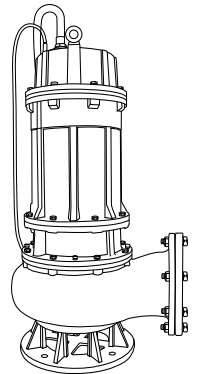

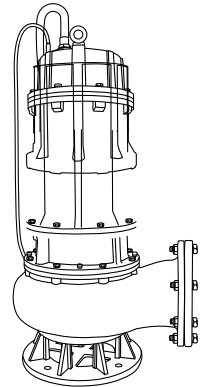

REFACCIÓN	COBA6/ 400/3460	COBA8/ 400/3460	COBA10/ 400/3460	COBA12/ 400/3460	CÓDIGO
CONECTOR MANGUERA COBA6	√				R-COB6 CONM
CONECTOR MANGUERA COBA8		√			R-COB8 CONM
CONECTOR MANGUERA COBA10			√		R-COB10 CONM
BRIDA DESCARGA CABA 12				√	R-COBA12-CONTB
IMPULSOR	√				R-COBA6/400-IMP
		√			R-COBA8/400-IMP
			√		R-COBA10/400-IMP
				√	R-COBA12/400-IMP
BALERO SUP. COBA6/8/10 40HP	√	√	√		R-COBA6810400-BSUP
BALERO SUP. COBA12 40HP				√	R-COBA12400-BSUP
BALERO INF. COBA6/8/10 40HP	√	√	√		R-COBA6810400-BINF
BALERO INF. COBA12 40HP				√	R-COBA12400-BINF
SELLO MEC. COBA6/8/10 40HP	√	√	√		R-COBA6810400-SELM
SELLO MECANICO COBA12 40HP				√	R-COBA12400-SELM
ANILLO DE SELLADO COBA6 40HP	√				R-COBA6/400-ASELL
ANILLO DE SELLADO COBA8 40HP		√			R-COBA8/400-ASELL
ANILLO DE SELLADO COBA10 40HP			√		R-COBA10/400-ASELL
ANILLO DE SELLADO COBA12 40HP				√	R-COBA12/400-ASELL
EMPAQUES 36A COBA6/8/10 40HP	√	√	√		R-COBA6810400-E36A
EMPAQUES 36A COBA12 40HP				√	R-COBA12400-E36A
EMPAQUES 36B COBA6/8/10 40HP	√	√	√		R-COBA6810400-E36B
EMPAQUES 36B COBA12 40HP				√	R-COBA12400-E36B
EMPAQUES 36D COBA6/8/10 40HP	√	√	√		R-COBA6810400-E36D
EMPAQUES 36D COBA12 40HP				√	R-COBA12400-E36D
EMPAQUES 36E COBA6/8/10 40HP	√	√	√		R-COBA6810400-E36E
EMPAQUES 36E COBA12 40HP				√	R-COBA12400-E36E
EMPAQUES 36G COBA6/8/10 40HP	√	√	√		R-COBA6810400-E36G
EMPAQUES 36G COBA12 40HP				√	R-COBA12400-E36G
JUNTA TORICA COBA6 40HP	√				R-COBA6400-JTORICA
JUNTA TORICA COBA8 40HP		√			R-COBA8400-JTORICA
JUNTA TORICA COBA10 40HP			√		R-COBA10400-JTORIC
JUNTA TORICA COBA12 40HP				√	R-COBA12400-JTORIC
DISTANCIADOR 41B COBA6/8/10 40HP	√	√	√		R-COBA6810400-D41B
DISTANCIADOR 41B COBA12 40HP				√	R-COBA12400-D41B
DISTANCIADOR 41C COBA6/8/10 40HP	√	√	√		R-COBA6810400-D41C
DISTANCIADOR 41C COBA12 40HP				√	R-COBA12400-D41C
TORNILLO 42F COBA6/8/10 40HP	√	√	√		R-COBA6810400-T42F
TORNILLO 42F COBA12 40HP				√	R-COBA12400-T42F
CUÑA COBA6/8/10 40HP	√	√	√		R-COBA6810400-CUÑA
CUÑA COBA12 40HP				√	R-COBA12400-CUÑA
CONECT. 10M COBA6/8/10 40HP 460 V	√	√	√		R-COBA6810400-C43
CONECT. 10M COBA12 40HP 460V				√	R-COBA12400-C47X

ALTAMIRA® REFACCIONES BOMBAS COBÁ

REFACCIÓN	COBA6/500/3460	COBA8/500/3460	COBA10/500/3460	COBA12/500/3460	CÓDIGO
CONECTOR MANGUERA COBA6	√				R-COB6 CONM
CONECTOR MANGUERA COBA8		√			R-COB8 CONM
CONECTOR MANGUERA COBA10			√		R-COB10 CONM
BRIDA DESCARGA COBA12				√	R-COBA12-CONTB
IMPULSOR	√				R-COBA6/500-IMP
		√			R-COBA8/500-IMP
			√		R-COBA10/500-IMP
				√	R-COBA12/500-IMP
BALERO SUP. COBA6/8/10 50HP	√	√	√		R-COBA6810500-BSUP
BALERO SUP. COBA12 50HP				√	R-COBA12500-BSUP
BALERO INF. COBA6/8/10 50HP	√	√	√		R-COBA6810500-BINF
BALERO INF. COBA12 50HP				√	R-COBA12500-BINF
SELLO MECÁNICO COBA6/8/10 50HP	√	√	√		R-COBA6810500-SELM
SELLO MECANICO COBA12 50HP				√	R-COBA12500-SELM
ANILLO DE SELLADO COBA6 50HP	√				R-COBA6/500-ASELL
ANILLO DE SELLADO COBA8 50HP		√			R-COBA8/500-ASELL
ANILLO DE SELLADO COBA10 50HP			√		R-COBA10/500-ASELL
ANILLO DE SELLADO COBA12 50HP				√	R-COBA12/500-ASELL
EMPAQUES 36A COBA6/8/10 50HP	√	√	√		R-COBA6810500-E36A
EMPAQUES 36A COBA12 50HP				√	R-COBA12500-E36A
EMPAQUES 36B COBA6/8/10 50HP	√	√	√		R-COBA6810500-E36B
EMPAQUES 36B COBA12 50HP				√	R-COBA12500-E36B
EMPAQUES 36D COBA6/8/10 50HP	√	√	√		R-COBA6810500-E36D
EMPAQUES 36D COBA12 50HP				√	R-COBA12500-E36D
EMPAQUES 36E COBA6/8/10 50HP	√	√	√		R-COBA6810500-E36E
EMPAQUES 36E COBA12 50HP				√	R-COBA12500-E36E
EMPAQUES 36G COBA6/8/10 50HP	√	√	√		R-COBA6810500-E36G
EMPAQUES 36G COBA12 DE 50HP				√	R-COBA12500-E36G
JUNTA TORICA COBA6 50HP	√				R-COBA6500-JTORICA
JUNTA TORICA COBA8 50HP		√			R-COBA8500-JTORICA
JUNTA TORICA COBA10 50HP			√		R-COBA10500-JTORIC
JUNTA TORICA COBA12 50HP				√	R-COBA12500-JTORIC
DISTANCIADOR 41B COBA6/8/10 50HP	√	√	√		R-COBA6810500-D41B
DISTANCIADOR 41B COBA12 50HP				√	R-COBA12500-D41B
DISTANCIADOR 41C COBA6/8/10 50HP	√	√	√		R-COBA6810500-D41C
DISTANCIADOR 41C COBA12 50HP				√	R-COBA12500-D41C
TORNILLO 42F COBA6/8/10 50HP	√	√	√		R-COBA6810500-T42F
TORNILLO 42F COBA12 DE 50HP				√	R-COBA12500-T42F
CUÑA COBA6/8/10 50HP	√	√	√		R-COBA6810500-CUÑA
CUÑA COBA12 50HP				√	R-COBA12500-CUÑA
CONNECT. 10M COBA6/8/10 50HP 460V	√	√	√		R-COBA6810500-C43
CONNECT. 10M COBA12 50HP 460V				√	R-COBA12500-C47X

REFACCIÓN	COBA8/600/3460	COBA10/600/3460	COBA12/600/3460	CÓDIGO
CONECTOR MANGUERA COBA8	√			R-COB8 CONM
CONECTOR MANGUERA COBA10		√		R-COB10 CONM
BRIDA DESCARGA COBA12			√	R-COBA12-CONTB
IMPULSOR	√			R-COBA8/600-IMP
		√		R-COBA10/600-IMP
			√	R-COBA12/600-IMP
BALERO SUPERIOR COBA8/10 60HP	√	√		R-COBA810600-BSUP
BALERO SUPERIOR COBA12 60HP			√	R-COBA12600-BSUP
BALERO INFERIOR COBA8/10 60HP	√	√		R-COBA810600-BINF
BALERO INFERIOR COBA12 60HP			√	R-COBA12600-BINF
SELLO MECÁNICO COBA8/10 DE 60HP	√	√		R-COBA810600-SELM
SELLO MECANICO COBA12 DE 60HP			√	R-COBA12600-SELM
ANILLO DE SELLADO COBA8 60HP	√			R-COBA8/600-ASELL
ANILLO DE SELLADO COBA10 60HP		√		R-COBA10/600-ASELL
ANILLO DE SELLADO COBA12 60HP			√	R-COBA12/600-ASELL
EMPAQUES 36A COBA8/10 DE 60HP	√	√		R-COBA810600-E36A
EMPAQUES 36A COBA12 DE 60HP			√	R-COBA12-E36A
EMPAQUES 36B COBA8/10 DE 60HP	√	√		R-COBA810600-E36B
EMPAQUES 36B COBA12 DE 60HP			√	R-COBA12-E36B
EMPAQUES 36D COBA8/10 DE 60HP	√	√		R-COBA810600-E36D
EMPAQUES 36D COBA12 DE 60HP			√	R-COBA12-E36D
EMPAQUES 36E COBA8/10 DE 60HP	√	√		R-COBA810600-E36E
EMPAQUES 36E COBA12 DE 60HP			√	R-COBA12-E36E
EMPAQUES 36G COBA8/10 DE 60HP	√	√		R-COBA810600-E36G
EMPAQUES 36G COBA12 DE 60HP			√	R-COBA12600-E36G
JUNTA TORICA COBA8 60HP	√	√		R-COBA8600-JTORICA
JUNTA TORICA COBA10 60HP	√	√		R-COBA10600-JTORIC
JUNTA TORICA COBA12 60HP			√	R-COBA12600-JTORIC
DISTANCIADOR 41B COBA8/10 60HP	√	√		R-COBA810600-D41B
DISTANCIADOR 41B COBA12 60HP			√	R-COBA12600-D41B
DISTANCIADOR 41C COBA8/10 60HP	√	√		R-COBA810600-D41C
DISTANCIADOR 41C COBA12 60HP			√	R-COBA12600-D41C
TORNILLO 42F COBA8/10 DE 60HP	√	√		R-COBA810600-T42F
TORNILLO 42F COBA12 DE 60HP			√	R-COBA12600-T42F
CUÑA COBA8/10 60HP	√	√		R-COBA810600-CUÑA
CUÑA COBA12 60HP			√	R-COBA12600-CUÑA
CONEC. 10M COBA8/10 DE 60HP 460V	√	√		R-COBA810600-C43
CONEC. 10M COBA12 DE 60HP 460V			√	R-COBA12600-C47

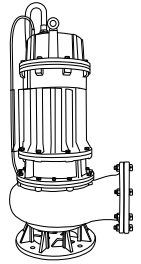

REFACCIÓN	COBA8/750/3460	COBA10/750/3460	COBA12/750/3460	CÓDIGO
BRIDA DESCARGA COBA8	√			R-COB8 CONM
BRIDA DESCARGA COBA10		√		R-COB10 CONM
BRIDA DESCARGA COBA12			√	R-COBA12-CONTB
IMPULSOR	√			R-COBA8/750-IMP
		√		R-COBA10/750-IMP
			√	R-COBA12/750-IMP
BALERO SUP. COBA8/10/12 75HP	√	√	√	R-COB81012750-BSUP
BALERO INF. COBA8/10/12 75HP	√	√	√	R-COB81012750-BINF
SELLO MEC. COBA8/10/12 75HP	√	√	√	R-COBA81012750-SM
ANILLO DE SELLADO COBA8 75HP	√			R-COBA8-750-ASELL
ANILLO DE SELLADO COBA10 75HP		√		R-COBA10-750-ASELL
ANILLO DE SELLADO COBA12 75HP			√	R-COBA12-750-ASELL
EMPAQUES 36A COBA8/10/12 75HP	√	√	√	R-COB81012750-E36A
EMPAQUES 36B COBA8/10/12 75HP	√	√	√	R-COB81012750-E36B
EMPAQUES 36C COBA8/10/12 75HP	√	√	√	R-COB81012750-E36C
EMPAQUES 36D COBA8/10/12 75HP	√	√	√	R-COB81012750-E36D
EMPAQUES 36E COBA8/10/12 75HP	√	√	√	R-COB81012750-E36E
EMPAQUES 36F COBA8/10/12 75HP	√	√	√	R-COB81012750-E36F
JUNTA TORICA COBA8 75HP	√			R-COBA8750-JTORICA
JUNTA TORICA COBA10 75HP		√		R-COBA10750-JTORIC
JUNTA TORICA COBA12 75HP			√	R-COBA12750-JTORIC
DISTANC. 41D COBA8/10/12 75HP	√	√	√	R-COB81012750-D41D
TORNILLO 42A COBA8/10/12 75HP	√	√	√	R-COB81012750-T42A
CUÑA COBA8/10/12 75HP	√	√	√	R-COB81012750-CUÑA
CONECT. 10M COBA8/10/12 DE 75HP 460V	√	√	√	R-CO81012750-C47AX
CONEC.SENS.TEMP 10M COBA8 A 12 75HP	√	√	√	R-CO81012750-C47BX
SENS.SOBRE.TEMP COBA8/10/12 75HP	√	√	√	R-COB81012750-SST
SENS. CAM. SELLO COBA8/10/12 75HP	√	√	√	R-COB81012750-SCS

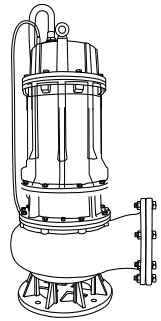

REFACCIÓN	COBA8/ 1000/3460	COBA10/ 1000/3460	COBA12/ 1000/3460	CÓDIGO
BRIDA DESCARGA COBA8	√			R-COB8 CONM
BRIDA DESCARGA COBA10		√		R-COB10 CONM
BRIDA DESCARGA COBA12			√	R-COBA12-CONTB
IMPULSOR	√			R-COBA8/1000-IMP
		√		R-COBA10/1000-IMP
			√	R-COBA12/1000-IMP
BALERO SUP. COBA8/10/12 DE 75HP	√	√	√	R-COB810121000-BSU
BALERO INF. COBA8/10/12 DE 75HP	√	√	√	R-COB810121000-BIN
SELLO MEC. COBA8/10/12 75HP	√	√	√	R-COBA810121000-SM
ANILLO DE SELLADO COBA8 75HP	√			R-COBA8-1000-ASEL
ANILLO DE SELLADO COBA10 75HP		√		R-COBA10-1000-ASEL
ANILLO DE SELLADO COBA12 75HP			√	R-COBA12-1000-ASEL
EMPAQUES 36A COBA8/10/12 75HP	√	√	√	R-CO810121000-E36A
EMPAQUES 36B COBA8/10/12 75HP	√	√	√	R-CO810121000-E36B
EMPAQUES 36C COBA8/10/12 75HP	√	√	√	R-CO810121000-E36C
EMPAQUES 36D COBA8/10/12 75HP	√	√	√	R-CO810121000-E36D
EMPAQUES 36E COBA8/10/12 75HP	√	√	√	R-CO810121000-E36E
EMPAQUES 36F COBA8/10/12 75HP	√	√	√	R-CO810121000-E36F
JUNTA TORICA COBA8 75HP	√			R-COB81000-JTORICA
JUNTA TORICA COBA10 75HP		√		R-COB101000-JTORIC
JUNTA TORICA COBA12 75HP			√	R-COB121000-JTORIC
DISTANCIADOR 41D COBA8/10/12 100HP	√	√	√	R-CO810121000-D41D
TORNILLO 42A COBA8/10/12 100HP	√	√	√	R-CO810121000-T42A
CUÑA COBA8/10/12 100HP	√	√	√	R-CO810121000-CUÑA
CONECT. 10M COBA8/10/12 75HP 460V	√	√	√	R-CO81012750-C47AX
CONEC.SENS.TEMP. 10M COBA8 A 12 75HP	√	√	√	R-CO81012750-C47BX
SENS.TEMP. MOTOR COBA8/10/12 100HP	√	√	√	R-CO810121000-STM
SENS. CAMARA SELLO COBA8/10/12 100HP	√	√	√	R-CO810121000-SCS

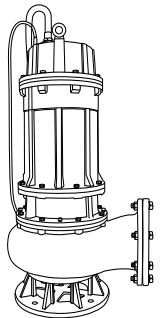

ALTAMIRA® REFACCIONES

TANQUES PRECARGADOS XH

REFACCIÓN	ALTAPRO XH25M-52	ALTAPRO XH25M-132	CÓDIGO
MEMBRANA INTERCAMBIABLE		√	MEMBRANAXH-132
	√		MEMBRANAXH-52
BRIDA		√	BRIDA-INF-132G
	√		BRIDA-INF-52G
VÁLVULA	√	√	VALVULAXH-52-132

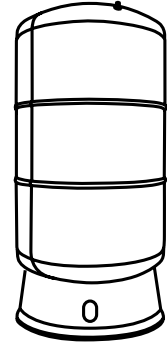

ALTAMIRA® REFACCIONES

BOMBAS AMIGA Y MARINA

REFACCIÓN	AMIGA 20A	AMIGA 100A	MARINA 100A	CÓDIGO
ADAPTADOR DESCARGA		√	√	R-AMI/MAR100ADAP
DESCARGA	√			R-AMIGA20/DESC
		√	√	R-AMI/MAR100DESC
BALERO	√			R-AMI20BALERO
		√	√	R-AMI/MAR100BALIN
		√	√	R-AMI/MAR100BALS
CABLE CONECTOR	√			R-AMIGA20/CABLE
		√	√	R-AMI/MAR100CABLE
CAPACITOR	√			R-AMIGA20/CAPA
		√	√	R-AMI/MAR100CAP
CUBIERTA DE MOTOR	√			R-AMIGA20/CMOT
		√	√	R-AMI/MAR100CMOT
COLADOR	√			R-AMIGA20/COL
		√	√	R-AMI/MAR100COL
		√	√	R-AMI/MAR100COL
FLOTADOR	√			R-AMIGA20/FLOT
		√	√	R-AMI/MAR100FLOT
IMPULSOR	√			R-AMIGA20/IMP
		√	√	R-AMI/MAR100IMP
JUNTA TÓRICA	√			R-AMIGA20/JUNT
		√	√	R-AMI/MAR100JUNT
RETEN	√			R-AMI20RETEN
		√	√	R-AMI/MAR100RETEN
SELLO MECANICO	√			R-AMI/MAR20SELMEC
		√	√	R-AMI/MAR100SELMEC
CUERPO DE BOMBA	√			R-AMI20CUERPOMB
		√		R-AMIGA100CBOM
			√	R-MARINA100CBOM

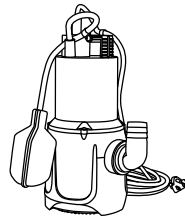

REFACCIÓN	INCLUYE	KOR 0.7	KOR 1.2	KOR 2	KOR 3	KOR 4.5	CÓDIGO
KIT DE REPARACIÓN MENOR PARA 5 PASOS KOR07/1.2/2	<ul style="list-style-type: none"> • 5 Bujes intermedio • 5 Anillos de sellado 	√	√	√			K07/1.2/2R-KREP10
KIT DE REPARACIÓN MENOR PARA 5 PASOS KOR3	<ul style="list-style-type: none"> • 5 Bujes intermedio • 5 Anillos de sellado 				√		K3R-KREP5
KIT DE REPARACIÓN MENOR PARA 5 PASOS KOR4.5	<ul style="list-style-type: none"> • 5 Bujes intermedio • 5 Anillos de sellado 					√	K4.5R-KREP5
KIT DE TUERCA Y CONO PARA 1 PASO KOR07/1.2/2	<ul style="list-style-type: none"> • 1 Anillo de paro • 1 Tuerca de fijación • 1 Arandela de anillo de paro 	√	√	√			K07/1.2/2R-KTAP
KIT DE TUERCA Y CONO PARA 5 PASOS DE LA KOR3	<ul style="list-style-type: none"> • 5 conos para impulsor • 5 tuercas para cono 				√		K3R-KREPTC5
KIT DE TUERCA Y CONO PARA 5 PASOS DE LA KOR4.5	<ul style="list-style-type: none"> • 5 conos para impulsor • 5 tuercas para cono 					√	K4.5R-KREPTC5
KIT DE TAZÓN SUPERIOR KOR07/1.2/2 DE 4-27 PASOS	<ul style="list-style-type: none"> • 1 Guía de válvula check • 1 Tapa de válvula check • 1 Asiento de válvula check • 1 Cubierta de válvula check • 1 Anillo de paro 	√	√	√			K07/1.2/2R-KTS6-27
KIT DE TAZÓN SUPERIOR KOR07/1.2 DE 31-58 PASOS	<ul style="list-style-type: none"> • Tazón de descarga 	√	√				K07/1.2R-TD
KIT DE TAZÓN SUPERIOR KOR2 DE 39-52 PASOS	<ul style="list-style-type: none"> • Tazón de descarga 			√			K2R-TD

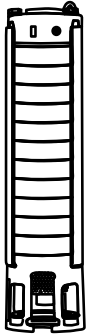

ALTAMIRA® REFACCIONES BOMBAS SERIE KOR 6" y 8"

REFACCIÓN	INCLUYE	KOR6	KOR10	KOR15	KOR20	KOR25	KOR32	KOR40	KOR53	KOR70	CÓDIGO		
KIT DE REPARACIÓN MENOR PARA 5 PASOS	<ul style="list-style-type: none"> • 5 Bujes intermedio • 5 Anillos de sellado • 5 Anillos de desgaste 	√									K6R-KREP5		
			√									K10R-KREP5	
				√	√								K15/20R-KREP5
							√	√					K25/32R-KREP5
									√				K40R-KREP5
										√			K53R-KREP5
KIT DE REPARACIÓN MENOR PARA 4 PASOS	<ul style="list-style-type: none"> • 3 Bujes intermedio • 3 Anillos de sellado • 3 Anillos de desgaste 									√	K70R-KREP5		
KIT DE REPARACIÓN MENOR PARA ESTANDAR	• 1 Arandela espaciadora	√									K06R-AE		
KIT DE REPARACIÓN MENOR PARA ESTANDAR	<ul style="list-style-type: none"> • 1 Arandela espaciadora • 1 Anillo de paro • 1 Buje superior • 1 Buje inferior 		√								K10R-KREP-STD		
KIT DE REPARACIÓN MENOR PARA ESTANDAR	<ul style="list-style-type: none"> • 1 Arandela espaciadora • 1 Anillo de paro • 1 Buje superior • 1 Buje inferior • Anillo de sellado inferior 			√	√						K15/20R-KREP-STD		
KIT DE REPARACIÓN MENOR PARA ESTANDAR	<ul style="list-style-type: none"> • 1 Arandela espaciadora • 1 Anillo de paro • 1 Buje inferior 					√	√				K25/32R-KREP-STD		
KIT DE REPARACIÓN MENOR PARA ESTANDAR	<ul style="list-style-type: none"> • 1 Arandela espaciadora • 1 Buje superior 							√	√		K40/53R-KREP-STD		
										√		K70R-KREP-STD	
KIT DE TUERCA Y CONO PARA 5 PASOS	<ul style="list-style-type: none"> • 5 conos para impulsor • 5 tuercas para cono 	√									K06R-KREPTC5		
			√	√	√							K10/20R-KREPTC5	
							√	√					K25/32R-KREPTC5
									√	√			K40/53R-KREPTC5
											√		K70R-KREP5



REFACCIÓN	LIFT50-4 -1127A	LIFT50-5 -1127A	LIFT50-6 -1230A	LIFT120-4 -1230A	CÓDIGO
ARANDELA	√	√	√	√	R-LIFT-A1
	√	√	√	√	R-LIFT-A2
	√	√	√		R-LIFT50-ATF
				X	R-LIFT120-ATF
	√	√	√	√	R-LIFT-AOND
BALERO	√	√	√	√	R-LIFT-BSUP
	√	√	√		R-LIFT50-BINF
				√	R-LIFT120-BINF
CABLE DE ALIMENTACIÓN			√		R-LIFT50-6-CA10M
	√	√		√	R-LIFT5045-120-CA
CANDADO	√	√	√	√	R-LIFT-CBAL
CAPACITOR 25µF	√		√		R-LIFT50-4-CAP25MF
CAPACITOR 30µF		√			R-LIFT50-5-CAP30MF
CAPACITOR 35µF				√	R-LIFT120-CAP35MF
CONECTOR	√	√	√	√	R-LIFT-CONT
CUERPO DE BOMBA	√				R-LIFT50-4-CB
		√			R-LIFT50-5-CB
			√		R-LIFT50-6-CB
				√	R-LIFT120-4-CB
DIFUSOR	√	√	√		R-LIFT50-DIF
				√	R-LIFT120-DIF
DISTANCIADOR				√	R-LIFT120-DST1
				√	R-LIFT120-DST2
	√	√	√	√	R-LIFT-DST3
	√				R-LIFT50-4-DST4
		√			R-LIFT50-5-DST4
			√	√	R-LIFT-DST4
EMPAQUE	√	√	√	√	R-LIFT-EMPC
FLOTADOR				√	R-LIFT-FLOT
IMPULSOR	√	√	√		R-LIFT50-IMP
				√	R-LIFT120-IMP
O-RING	√	√	√	√	R-LIFT-ORING1
	√	√	√	√	R-LIFT-ORING2
	√	√	√	√	R-LIFT-ORING3
PLATO INFERIO	√	√	√		R-LIFT50-PINF
				√	R-LIFT120-PINF
PLATO SUPERIOR	√	√	√	√	R-LIFT-PSUP
REJILLA DE SUCCIÓN	√	√	√	√	R-LIFT-RS
SELLO MECÁNICO	√	√	√	√	R-LIFT-SM
TAPA DIFUSOR	√	√	√		R-LIFT50-TDF
				√	R-LIFT120-TDF
TAPA SUPERIOR DE MOTOR	√	√	√	√	R-LIFT-TSMP
TAPONES REJILLA SUCC	√	√	√	√	R-LIFT-TRS
TORNILLO DE FLECHA	√	√	√	√	R-LIFT-TF
ANILLO INOX LIFT120				√	R-LIFT120-AINOX
RETEN	√	√	√	√	R-LIFT-LSELL

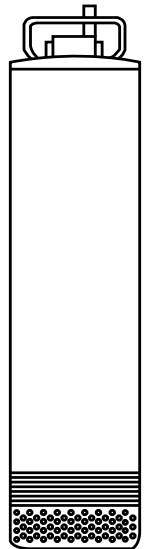

REFACCIÓN	TRPS-C-550-2X2	TRPS-D-550-2X2	CÓDIGO
SELLO MECANICO	√	√	R-TRPS-SELL-MEC
EMPAQUES	√	√	R-TRPS-KIT-EMP
BALEROS	√	√	R-TRPS-KIT-BALEROS
IMPULSOR	√	√	R-TRPS-IMPULSOR
CUÑA	√	√	R-TRPS-CUÑA
KIT TAPONES PARA ACEITE	√	√	R-TRPS-KIT-TAPONES
ENGRANAJE	√	√	R-TRPS-ENGRANE
PIÑÓN	√	√	R-TPRS-PIÑÓN
COPLES		√	R-TRPS-KIT-COPLE1
	√		R-TRPS-KIT-COPLE2

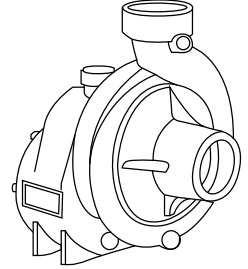

ALTAMIRA® REFACCIONES BOMBAS SERIE 14NX



REFACCIÓN	14NX75-1-1A	14NX100-2-2C	14NX150-2-2A	14NX200-3-2A-1B	14NX250-4-4B	14NX300-5-1A-3B-1C	14NX400-6-1A-3B	14NX500-7-6A-1B	14NX600-9-1A-8B	14NX750-10-10A	14NX1000-14-10A-4B	14NX1250-17-17A	CÓDIGO
ADAPTADOR CON BUJE 6"	√	√	√	√	√	√	√	√	√				14NX-ADAP 6"
ADAPTADOR CON BUJE 8"										√	√	√	14NX-ADAP 8"
TAZÓN SUPERIOR CON BUJE	√	√	√	√	√	√	√	√	√	√			14NX-TS
											√	√	14NX-TS-AP
TAZÓN INTERMEDIO CON BUJE	√	√	√	√	√	√	√	√	√	√			14NX-TI
											√	√	14NX-TI-AP
IMPULSOR RECORTE "A" CON CONO	√		√	√		√	√	√	√	√	√	√	14NX-IMPR A
IMPULSOR RECORTE "B" CON CONO				√	√	√	√	√	√	√	√	√	14NX-IMPR B
IMPULSOR RECORTE "C" CON CONO		√				√							14NX-IMPR C
GUARDA CABLE	√												14NX-1 GC 6"
		√	√										14NX-2 GC 6"
				√									14NX-3 GC 6"
					√								14NX-4 GC 6"
						√							14NX-5 GC 6"
							√						14NX-6 GC 6"
								√					14NX-7 GC 6"
									√				14NX-9 GC 6"
										√			14NX-10 GC 8"
											√		14NX-14 GC 8"
											√	14NX-17 GC 8"	

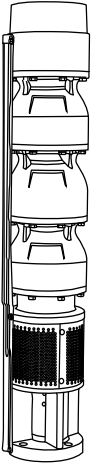

ALTAMIRA® REFACCIONES BOMBAS SERIE 22NX

REFACCIÓN	22NX75-1-1B	22NX100-2-2C	22NX150-2-1B-1C	22NX200-3-2B-1C	22NX250-3-1A-2B	22NX300-3-2A-1B	22NX400-4-2A-2B	22NX400-5-2A-3B	22NX500-6-2A-4B	22NX600-7-3A-4B	22NX750-7-7A	22NX1000-9-9A	22NX1250-12-10A-2B	CÓDIGO
DAPTADOR CON BUJE 6"	√	√	√	√	√	√	√	√	√	√				22NX-ADAP 6"
ADAPTADOR CON BUJE 8"											√	√	√	22NX-ADAP 8"
TAZÓN SUPERIOR CON BUJE	√	√	√	√	√	√	√	√	√	√	√	√	√	22NX-TS
TAZÓN INTERMEDIO CON BUJE	√	√	√	√	√	√	√	√	√	√	√	√	√	22NX-TI
IMPULSOR RECORTE "A" CON CONO					√	√	√	√	√	√	√	√	√	22NX-IMPR A
IMPULSOR RECORTE "B" CON CONO	√		√	√	√	√	√	√	√	√			√	22NX-IMPR B
IMPULSOR RECORTE "C" CON CONO		√	√	√										22NX-IMPR C
GUARDA CABLE	√													14/63NX-GC8"
		√	√											22NX-2 GC 6"
				√	√	√								22NX-3 GC 6"
						√	√							22NX-5 GC 6"
							√							22NX-6 GC 6"
								√						22NX-6 GC 6"
									√					22NX-7 GC 6"
										√				22NX-7 GC 8"
											√			22NX-9 GC 8"
												√		22NX-12 GC 8"

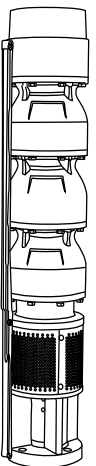

REFACCIÓN	35NX100-1-1B	35NX200-2-2B	35NX250-2-2A	35NX300-3-3B	35NX400-4-4B	35NX500-4-4A	35NX600-5-3A-2B	35NX750-6-5A-1B	35NX1000-8-6A-2B	35NX1250-10-7A-3B	CÓDIGO
ADAPTADOR CON BUJE 6"	√	√	√	√	√	√	√	√			35/44NX-ADAP 6"
ADAPTADOR CON BUJE 8"									√	√	35/44NX-ADAP 8"
TAZÓN SUPERIOR CON BUJE	√	√	√	√	√	√	√	√	√	√	35/44NX-TS
TAZÓN INTERMEDIO CON BUJE	√	√	√	√	√	√	√	√	√	√	35/44NX-TI
IMPULSOR RECORTE "A"			√			√	√	√	√	√	35NX-IMPR A
IMPULSOR RECORTE "B"	√	√		√	√		√	√	√	√	35NX-IMPR B
GUARDA CABLE	√										35/44NX-1 GC 6"
		√	√								35/44NX-2 GC 6"
				√							35/44NX-3 GC 6"
					√	√					35/44NX-4 GC 6"
							√				35/44NX-5 GC 6"
								√			35/44NX-6 GC 8"
									√		35/44NX-8 GC 8"
									√		35/44NX-10 GC 8"

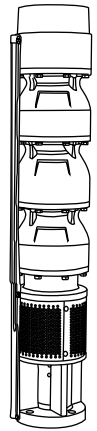
REFACCIONES BOMBAS SERIE 44NX

REFACCIÓN	44NX150-1-1C	44NX250-1-1A	44NX300-2-1B-1C	44NX400-2-2A	44NX500-3-1A-1B-1C	44NX600-4-2B-2C	44NX750-4-1A-3B	44NX1000-5-4A-1B	44NX1250-6-4A-2B	44NX1500-7-2A-3B	CÓDIGO
ADAPTADOR CON BUJE 6"	√	√	√	√	√	√					35/44NX-ADAP 6"
ADAPTADOR CON BUJE 8"							√	√	√	√	35/44NX-ADAP 8"
TAZÓN SUPERIOR CON BUJE	√	√	√	√	√	√	√	√	√	√	35/44NX-TS
TAZÓN INTERMEDIO CON BUJE	√	√	√	√	√	√	√	√	√	√	35/44NX-TI
IMPULSOR RECORTE "A"		√			√		√	√	√	√	44NX-IMPR A
IMPULSOR RECORTE "B"			√		√	√	√	√	√	√	44NX-IMPR B
IMPULSOR RECORTE "C"	√		√		√	√					44NX-IMPR C
GUARDA CABLE	√	√									35/44NX-1 GC 6"
			√								35/44NX-2 GC 6"
				√							35/44NX-3 GC 6"
					√						35/44NX-4 GC 6"
						√					35/44NX-4 GC 8"
							√				35/44NX-5 GC 8"
								√			35/44NX-6 GC 8"
								√			35/44NX-7 GC 8"

REFACCIONES BOMBAS SERIE 45NX

REFACCIÓN	45NX250-1-1C	45NX300-1-1B	45NX400-1-1A	45NX500-2-1B-1C	45NX600-2-1A-1B	45NX750-3-2B-1C	45NX1000-4-2B-2C	45NX1250-5-3B-2C	45NX1500-5-3A-2B	45NX1750-6-3A-2B1C	45NX2000-7-3A-3B1C	CÓDIGO
ADAPTADOR CON BUJE 6"	√	√	√	√	√							45/66/75NX-ADAP6"
ADAPTADOR CON BUJE 8"						√	√	√	√	√	√	45/66/75NX-ADAP8"
TAZÓN SUPERIOR CON BUJE	√	√	√	√	√	√	√	√	√	√	√	45NX-TS
TAZÓN INTERMEDIO CON BUJE	√	√	√	√	√	√	√	√	√	√	√	45NX-TI
IMPULSOR RECORTE "A" CON CONO			√		√				√	√	√	45NX-IMPR A
IMPULSOR RECORTE "B" CON CONO		√		√	√	√	√	√	√	√	√	45NX-IMPR B
IMPULSOR RECORTE "C" CON CONO	√			√	√	√	√	√	√	√	√	45NX-IMPR C
GUARDA CABLE	√											45/66/75NX-AB-GC
		√	√		√							45/66/75NX-1 GC
				√								45/66/75NX-2 GC
						√						45/66/75NX-3 GC
							√					45/66/75NX-4 GC
								√	√			45/66/75NX-5 GC
										√		45/66/75NX-6 GC
										√		45/66/75NX-7 GC

REFACCIÓN	63NX250-1-1A	63NX400-2-1A-1B	63NX600-3-1A-2B	63NX750-4-1A-3B	63NX1000-5-3A-2B	63NX1250-7-7B	CÓDIGO
ADAPTADOR CON BUJE 6"	√	√	√				63NX-ADAP 6"
ADAPTADOR CON BUJE 8"				√	√	√	63NX-ADAP 8"
TAZÓN SUPERIOR CON BUJE	√	√	√	√	√	√	63NX-TS
TAZÓN INTERMEDIO CON BUJE	√	√	√	√	√	√	63NX-TI
IMPULSOR RECORTE "A"	√	√	√	√	√	√	63NX-IMPR A
IMPULSOR RECORTE "B"		√	√	√	√	√	63NX-IMPR B
GUARDA CABLE	√						63NX-1 GC 6"
		√					63NX-2 GC 6"
			√				63NX-3 GC 6"
				√			63NX-4 GC 8"
					√		63NX-5 GC 8"
					√	63NX-7 GC 8"	

REFACCIONES BOMBAS SERIE 66NX

REFACCIÓN	66NX500-1-1B	66NX600-1-1A	66NX1000-2-1A-1C	66NX1250-3-3C	66NX1500-3-1A-1B1C	66NX1750-4-1B-3C	66NX2000-4-1A-3B	CÓDIGO
REJILLA DE SUCCIÓN C/TORNILLOS 6"	√	√						NX-COLADOR ADAP 6"
REJILLA DE SUCCIÓN C/TORNILLOS 8"			√	√	√	√	√	NX-COLADOR ADAP 8"
COPEL 6"	√	√						NX-COPL6"
ADAPTADOR CON BUJE 6"	x	√						45/66/75NX-ADAP6"
ADAPTADOR CON BUJE 8"			√	√	√	√	√	45/66/75NX-ADAP8"
TAZÓN SUPERIOR CON BUJE	√	√	√	√	√	√	√	66/75NX-TS
TAZÓN INTERMEDIO CON BUJE			√	√	√	√	√	66/75NX-TI
IMPULSOR RECORTE "A" CON CONO		√	√		√	√	√	66NX-IMPR A
IMPULSOR RECORTE "B" CON CONO	√				√	√	√	66NX-IMPR B
IMPULSOR RECORTE "C" CON CONO			√	√	√	√		66NX-IMPR C
GUARDA CABLE	√	√						45/66/75NX-1 GC
			√					45/66/75NX-2 GC
				√	√			45/66/75NX-3 GC
						√	√	45/66/75NX-4 GC

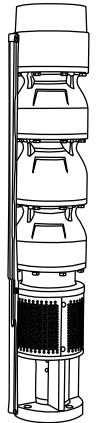

REFACCIONES BOMBAS SERIE 75NX

REFACCIÓN	75NX600-1-1B	75NX750-1-1A	75NX1000-2-1B-1C	75NX1250-2-1A-1B	75NX1500-3-1B-2C	75NX1750-3-2A-1C	75NX2000-4-1A-3C	CÓDIGO
ADAPTADOR CON BUJE 6"	√							45/66/75NX-ADAP6"
ADAPTADOR CON BUJE 8"		√	√	√	√	√	√	45/66/75NX-ADAP8"
TAZÓN SUPERIOR CON BUJE	√	√	√	√	√	√	√	66/75NX-TS
TAZÓN INTERMEDIO CON BUJE			√	√	√	√	√	66/75NX-TI
IMPULSOR RECORTE "A" CON CONO		√	√			√	√	75NX-IMPR A
IMPULSOR RECORTE "B" CON CONO	√		√	√	√	√	√	75NX-IMPR B
IMPULSOR RECORTE "C" CON CONO			√	√	√	√	√	75NX-IMPR C
GUARDA CABLE	√	√						45/66/75NX-1 GC
			√	√				45/66/75NX-2 GC
					√			45/66/75NX-3 GC
						√	√	45/66/75NX-4 GC

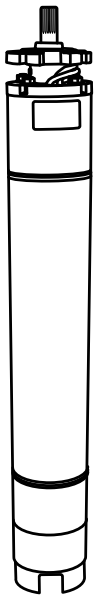

REFACCIÓN	MSRT6 7 53230	MSRT6 7 53460	MSRT6 103230	MSRT6 103460	MSRT6 153230	MSRT6 153460	MSRT6 203230	MSRT6 203460	MSRT6 253230	MSRT6 253460	MSRT6 303230	MSRT6 303460	MSRT6 403230	MSRT6 403460	MSRT6 503230	MSRT6 503460	MSRT18/6 603460	MSRT6 753460	MSRT18 1003460	MSRT10/8 1253460	MSRT10/8 1503460	MSRT10/8 1753460	MSRT10/8 2003460	MSRT12/10 2503460	CÓDIGO			
ADAPTADOR BRIDA																	√									R-AB-MSW8/6-60		
																		√	√							R-AB-MSW8/6-75/100		
																					√	√	√	√		R-AB-MSW10/8		
																									√		R-AB-MSW12/10	
BUJE DE GRAFITO	√	√	√	√	√	√																				R-BUJEGRW7.5-15		
							√	√	√	√																	R-BUJEGRW20-25	
											√	√	√	√	√	√											R-BUJEINFGRW30-50	
																											R-BUJESPRGW30-50	
																											R-BUJEINFGRW60-100	
																											R-BUJESUPGRW60-100	
																											R-BUJEGRW125-200	
																										√	R-BUJEGRW250	
BUJE INOXIDABLE P. ROTOR	√	√	√	√	√	√																				R-BUJERINXW7.5-15		
							√	√	√	√																R-BUJERINXW20-25		
											√	√	√	√	√	√										R-BUJERINXW30-50		
																											R-BUJERINFW60-100	
																											R-BUJERSUPW60-100	
																											R-BUJERINXW125-200	
CAJA DE AJUSTE	√	√	√	√	√	√	√	√	√	√	√	√	√	√	√	√										R-BUJERINXW250		
																											R-CA-MSW6	
																		√	√	√						R-CA-MSW8		
																											R-CA-MSW10	
CABLE CONECTOR	√	√	√	√	√	√	√	√	√	√	√	√	√	√	√	√										R-CC3X6MSW"		
																											R-CC3X10MSW"	
																											R-CC3X16MSW" 5M	
																											R-CC1X25MSW"	
																											R-CC1X35MSW"	
CONJUNTO DE SEGMENTOS	√	√	√	√	√	√	√	√	√	√	√	√	√	√	√	√										R-CCMSW12/10"250		
																											R-CDSEG-MSW6"	
																											R-CDSEG-MSW8"	
																											R-CDSEG-MSW10/8"	
CUBIERTA SUPERIOR	√	√	√	√	√	√	√	√	√	√	√	√	√	√	√	√										R-CDSEG-MSW12"		
	√	√	√	√	√	√	√	√	√	√	√	√	√	√	√	√										R-CS-MSW6-C		
																											R-CS-MSW6-L	
																											R-CS-MSW8C	
																											R-CS-MSW8L	
																											R-CS-MSW10	
DESARENADOR	√	√	√	√	√	√	√	√	√	√	√	√	√	√	√	√										R-CD-MSW12		
	√	√	√	√	√	√	√	√	√	√	√	√	√	√	√	√										R-MSRT6-DESARE		
																											R-DESARE-MSW6"	
																											R-MSRT8-DESARE	
																											R-DESARE-MSW8"	
																											R-MSRT10/8-DESARE	
DIAFRAGMA																											R-DESARE-MSW10/8"	
																											R-DESARE-MSW12/10"	
																											R-DIAF-MSW6"	
																											R-DIAF-MSW8"	
DISCO DE GRAFITO																											R-DIAF-MSW10/8"	
																											R-DIAF-MSW250	
																											R-DISCOGR-MSW6"	
INTERCAMBIADOR DE CALOR																											R-DISCOGR-MSW8"	
																											R-DISCOGR-MSW10/8"	
																											R-DISCOGR-MSW12"	
																											√	R-IC-MSW12

REFACCIÓN	MSRT6 7.53230	MSRT6 7.53460	MSRT6 103230	MSRT6 103460	MSRT6 153230	MSRT6 153460	MSRT6 203230	MSRT6 203460	MSRT6 253230	MSRT6 253460	MSRT6 303230	MSRT6 303460	MSRT6 403230	MSRT6 403460	MSRT6 503230	MSRT6 503460	MSRT8/6 603460	MSRT8 753460	MSRT8 1003460	MSRT108 1253460	MSRT108 1503460	MSRT108 1753460	MSRT108 2003460	MSRT12/10 2503460	CÓDIGO	
ARANDELA DE BAJA CARGA	√	√	√	√	√	√	√	√	√	√	√	√	√	√	√	√	√	√								R-PBCARGA-MSW6"
																		√	√	√						R-PBCARGA-MSW8"
																					√	√	√	√		R-PBCARGA-MSW10/8"
																									√	R-PBCARGA-MSW12/10"
SELLO CONECTOR	√		√		√		√			√																R-SECMSW7.5-20/230
																										R-SECMSW25/230
												√		√		√										R-SECMSW30-50/230
															√											R-SECMSW7.5-30/460
		√		√		√		√		√		√			√											R-SECMSW40-50/460
																√										R-SECMSW60/230-460
																	√	√								R-SECMSW75-100/460
																					√					R-SECMSW125/460
																						√				R-SECMSW150/460
																							√	√		R-SECMSW175-200
																									√	R-SECMSW250/460
	SOPORTE INFERIOR	√	√	√	√	√	√																			R-SI-MSW6
							√	√	√	√															R-SI-MSW6	
											√	√	√	√	√										R-SI2-MSW6	
																	√	√	√						R-SI-MSW8	
																		√	√	√	√				R-SI-MSW10	
SELLO MECÁNICO	√	√	√	√	√	√	√	√	√	√	√	√	√	√	√	√									R-MSRT6-SM	
	√	√	√	√	√	√	√	√	√	√	√	√	√	√	√	√									R-SM-MSW6"	
																	√	√	√						R-MSRT8-SM	
																	√	√	√						R-SM-MSW8"	
																				√	√	√	√		R-MSRT10-SM	
																				√	√	√	√		R-SM-MSW10/8"	
																								√	R-SM-MSW12/10"	
SOPORTE SUPERIOR	√	√	√	√	√	√																			R-SS-MSW6 7.5-15HP	
							√	√	√	√															R-SS-MSW6 20-25HP	
																	√	√	√						R-SS-MSW6 30-50HP	
																				√	√	√	√		R-SS-MSW8	
																					√	√	√	√	R-SS-MSW10	
TAPA SELLO MECÁNICO	√	√	√	√	√	√	√	√	√	√	√	√	√	√	√	√									R-MSRT6-TAPSM	
	√	√	√	√	√	√	√	√	√	√	√	√	√	√	√	√									R-TAPSM-MSW6"	
																	√	√	√						R-MSRT8-TAPSM	
																	√	√	√						R-TAPSM-MSW8"	
																				√	√	√	√		R-MSRT10/8-TAPSM	
																				√	√	√	√		R-TAPSM-MSW10/8"	
TAPA DE DIAFRAGMA	√	√	√	√	√	√	√	√	√	√	√	√	√	√	√										R-TD-MSW6	
																	√	√	√						R-TD-MSW8	
																			√	√	√	√		R-TD-MSW10		
																								√	R-TD-MSW12	
JUNTA AJUST. / SELLO MECAN	√	√	√	√	√	√	√	√	√	√	√	√	√	√	√										R-MSRT6-JA	
																√	√	√							R-MSRT8-JA	
SELLO CONECTOR P/PT100																				√	√	√	√		R-MSRT10-JA	
																					√	√	√	√	R-SECMSWPT100	



REFACCIÓN	MSAT4 1/21152H	MSAT4 1/212302H	MSAT4 1/21115	MSAT4 1/21230	MSAT4 1/23230	MSAT4 1/23460	MSAT4 3/412302H	MSAT4 3/41230	MSAT4 3/43230	MSAT4 3/43460	MSAT4 1/2302H	MSAT4 1/230	MSAT4 1/23230	MSAT4 1/23460	MSAT4 1/2302H	MSAT4 1/230	MSAT4 1/23230	MSAT4 1/23460	MSAT4 1/230	MSAT4 1/23230	MSAT4 1/23460	MSAT4 1/230	MSAT4 1/23230	MSAT4 1/23460	MSAT4 1/230	MSAT4 1/23230	MSAT4 1/23460	CÓDIGO		
ANILLO DE DESGASTE	√	√	√	√	√	√	√	√	√	√	√	√	√	√	√	√												R-TR4-ADES-0.5-1.5		
																	√	√	√	√	√	√							R-TR4-ADES-2.3	
																							√	√	√	√	√		R-TR4-ADES-5-7.5	
BASE	√	√	√	√	√	√	√	√	√	√	√	√	√	√	√	√	√	√	√	√	√							R-TR4-BASE-0.5-3		
																							√	√	√	√	√		R-TR4-BASE-5-7.5	
CABLE	√	√				√				√			√															R-TR4-CONEC-2H		
			√	√	√	√	√	√	√	√	√	√	√	√	√	√	√	√	√	√	√							R-TR4-CONEC-3H		
																						√	√	√	√	√	√	√	R-TR4-CONEC-3F	
CAJA DE AJUSTE																										√	√	√	√	R-TR4-CA-5-7.5
CALCE	√	√	√	√	√	√	√	√	√	√	√	√	√	√	√	√	√	√	√	√	√	√	√	√	√	√	√	R-TR4-CALCE		
CONJUNTO DE EMPUJE	√	√	√	√	√	√	√	√	√	√																		R-TR4-EMP-0.5-0.75		
											√	√	√	√	√	√	√	√	√	√	√							R-TR4-EMP-1-2		
																									√	√	√		R-TR4-EMP-3	
																											√	√	√	√
DESARENADOR	√	√	√	√	√	√	√	√	√	√	√	√	√	√	√	√	√	√	√	√	√	√	√	√	√	√	√	R-TR4-DESARENADOR		
DIAFRAGMA	√	√	√	√	√	√	√	√	√	√	√	√	√	√	√	√	√	√	√	√	√	√	√	√	√	√	√	R-TR4-DIAF-0.5-3		
																										√	√	√	√	R-TR4-DIAF-5-7.5
RETEN	√	√	√	√	√	√	√	√	√	√	√	√	√	√	√	√	√	√	√	√	√	√	√	√	√	√	√	R-TR4-RETEN		
SOPORTE INFERIOR	√	√	√	√	√	√	√	√	√	√																		R-TR4-SIN-0.5-0.75		
											√	√	√	√	√	√	√	√	√	√	√							R-TR4-SIN-1-2		
																									√	√	√		R-TR4-SIN-3	
																										√	√	√	√	R-TR4-SIN-5-7.5
SOPORTE SUPERIOR	√	√	√	√	√	√	√	√	√	√	√	√	√	√	√	√	√	√	√	√	√	√	√	√	√	√	√	R-TR4-SSUP-0.5-1.5		
																									√	√	√	√	R-TR4-SSUP-2.3	
																										√	√	√	√	R-TR4-SSUP-5-7.5
TAPA DE MOTOR	√	√	√	√	√	√	√	√	√	√	√	√	√	√	√	√	√	√	√	√	√	√	√	√	√	√	√	R-TR4-TAPA		
TORNILLOS	√	√	√	√	√	√	√	√	√	√	√	√	√	√	√	√	√	√	√	√	√	√	√	√	√	√	√	R-TR4-TORNILLOS		

REFACCIÓN	MSAT6 7.53230	MSAT6 7.53460	MSAT6 103230	MSAT6 103460	MSAT6 153230	MSAT6 153460	MSAT6 203230	MSAT6 203460	MSAT6 253230	MSAT6 253460	MSAT6 303230	MSAT6 303460	MSAT6 403460	MSAT6 503460	CÓDIGO
CABLE DE ALIMENTACIÓN	√	√	√	√	√	√		√		√		√			R-TR6-CONEC-10AWG
							√		√		√		√	√	R-TR6-CONEC-8AWG
CAJA DE AJUSTE	√	√	√	√	√	√	√	√	√	√	√	√			R-TR6-AJUST-7.5-30
													√	√	R-TR6-AJUST-40-50
CANDADO	√	√	√	√	√	√	√	√	√	√	√	√	√	√	R-TR6-CANDADO
CONJUNTO DE EMPUJE	√	√	√	√	√	√	√	√	√	√	√	√			R-TR6-EMP-7.5-30
													√	√	R-TR6-EMP-40-50
CUÑA	√	√	√	√	√	√	√	√	√	√	√	√	√	√	R-TR6-CUÑA
DIAFRAGMA	√	√	√	√	√	√	√	√	√	√	√	√	√	√	R-TR6-DIAFRAGMA
DESARENADOR	√	√	√	√	√	√	√	√	√	√	√	√	√	√	R-TR6-DESARENADOR
KIT DE DESGASTE	√	√	√	√	√	√	√	√	√	√	√	√	√	√	R-TR6-DESGASTE
SOPORTE SUPERIOR	√	√	√	√	√	√	√	√	√	√	√	√	√	√	R-TR6-SSUP-7.5-50
SELLO MECANICO	√	√	√	√	√	√	√	√	√	√	√	√	√	√	R-TR6-SELL-MEC-6"
SOPORTE INFERIOR	√	√	√	√	√	√	√	√	√	√	√	√	√	√	R-TR6-SINF-7.5-50
TAPON FILTRO	√	√	√	√	√	√	√	√	√	√	√	√	√	√	R-TR6-TAPON-FILTRO



REFACCIÓN	MSAE4 1/21127H														CÓDIGO												
	MSAE4 1/212302H	MSAE4 3/412302H	MSAE4 1/2302H	MSAE4 1.512302H	MSAE4 1/23230	MSAE4 1/23460	MSAE4 1/21127	MSAE4 1/21230	MSAE4 3/43460	MSAE4 3/43230	MSAE4 3/41230	MSAE4 13230	MSAE4 13460	MSAE4 1127		MSAE4 11230	MSAE4 1.53230	MSAE4 1.53460	MSAE4 1.51230	MSAE4 23230	MSAE4 23460	MSAE4 21230	MSAE4 33230	MSAE4 33460	MSAE4 31230		
TORNILLO PARA MOTOR	√	√	√	√	√	√	√	√	√	√	√	√	√	√	√	√	√	√	√	√	√	√	√	√	√	√	R-EVER4-TOR-BASE-1
BASE PARA MOTOR	√	√	√	√	√	√	√	√	√	√	√	√	√	√	√	√	√	√	√	√	√	√	√	√	√	√	R-EVER4-BASE-1
KIT DE O-RING	√	√	√	√	√	√	√	√	√	√	√	√	√	√	√	√	√	√	√	√	√	√	√	√	√	√	R-EVER4-KIT-O-RING
DIAFRAGMA	√	√	√	√	√	√	√	√	√	√	√	√	√	√	√	√	√	√	√	√	√	√	√	√	√	√	R-EVER4-DIAFRAGMA1
SOPORTE INFERIOR	√	√	√	√	√	√	√	√	√	√	√	√	√	√	√	√	√	√	√	√	√	√	√	√	√	√	R-EVER4-SOP-INF-1
KIT DE BUJES	√	√	√	√																							R-EVER4-KIT-BUJE1
					√	√	√	√	√	√	√	√	√	√	√	√	√	√	√	√	√	√	√	√	√	√	R-EVER4-KIT-BUJE2
																											R-EVER4-KIT-BUJE3
CONJUNTO EMPUJE	√	√	√	√	√	√	√	√	√	√	√	√	√	√	√												R-EVER4-EMPUJE1
																√	√	√	√	√	√	√	√	√	√	√	R-EVER4-EMPUJE2
																											R-EVER4-EMPUJE3
SOPORTE SUPERIOR	√	√	√	√	√	√	√	√	√	√	√	√	√	√	√	√	√	√	√	√	√	√	√	√	√	√	R-EVER4-SOP-SUP-1
																											R-EVER4-SOP-SUP-2
VALVULA DE ALIVIO	√	√	√	√	√	√	√	√	√	√	√	√	√	√	√	√	√	√	√	√	√	√	√	√	√	√	R-EVER4-VALV-AL
RETEN	√	√	√	√	√	√	√	√	√	√	√	√	√	√	√	√	√	√	√	√	√	√	√	√	√	√	R-EVER4-RETEN
TAPA SUPERIOR	√	√	√	√	√	√	√	√	√	√	√	√	√	√	√	√	√	√	√	√	√	√	√	√	√	√	R-EVER4-TAPA
BIRLO	√	√	√	√	√	√	√	√	√	√	√	√	√	√	√	√	√	√	√	√	√	√	√	√	√	√	R-EVER4-BIRLO
DESARENADOR	√	√	√	√	√	√	√	√	√	√	√	√	√	√	√	√	√	√	√	√	√	√	√	√	√	√	R-EVER4-DESARENADO
CABLE CONECTOR	√	√	√	√																							R-EVER4-CCONEC-1
					√	√	√	√	√	√	√	√	√	√	√												R-EVER4-CCONEC-2
																√	√	√	√	√	√	√	√	√	√	√	√

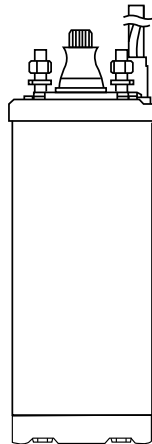

REFACCIÓN	MSAE4 112127ZH	MSAE4 1121200ZH	MSAE4 3141230ZH	MSAE4 11230ZH	MSAE4 151230ZH	MSAE4 1129230	MSAE4 1123460	MSAE4 1121127	MSAE4 1121230	MSAE4 3143460	MSEA4 3143230	MSAE4 3141230	MSAE4 13230	MSAE4 13460	MSAE4 11127	MSAE4 11230	MSAE4 153230	MSAE4 153460	MSAE4 151230	MSAE4 23230	MSAE4 23460	MSAE4 21230	MSAE4 33230	MSAE4 33460	MSAE4 31230	MSAE4 53230	MSAE4 53460	MSAE4 753230	MSAE4 753460	MSAE4 51230	MSAE4 103230	MSAE4 103460	CÓDIGO									
TORNILLO PARA	√	√	√	√	√	√	√	√	√	√	√	√	√	√	√	√	√	√	√	√	√	√	√	√											R-EVER4-TOR-BASE-1							
MOTOR																											√	√	√	√	√	√	√	√		R-EVER4-TOR-BASE-2						
BASE PARA MOTOR	√	√	√	√	√	√	√	√	√	√	√	√	√	√	√	√	√	√	√	√	√	√	√	√	√										R-EVER4-BASE-1							
																											√	√	√	√	√	√	√	√	√		R-EVER4-BASE-2					
DIAFRAGMA	√	√	√	√	√	√	√	√	√	√	√	√	√	√	√	√	√	√	√	√	√	√	√	√	√											R-EVER4-DIAFRAGMA1						
																											√	√	√	√	√	√	√	√	√	√		R-EVER4-DIAFRAGMA2				
CAJA DE AJUSTE																											√	√	√	√	√	√	√	√	√	√		R-EVER4-CAJUSTE				
CONJUNTO EMPUJE	√	√	√	√		√	√	√	√	√	√	√	√	√	√	√																					R-EVER4-EMPUJE1					
																		√	√	√	√	√	√	√	√												R-EVER4-EMPUJE2					
																											√	√	√	√	√	√	√	√	√	√	√		R-EVER4-EMPUJE3			
KIT DE O-RING	√	√	√	√	√	√	√	√	√	√	√	√	√	√	√	√	√	√	√	√	√	√	√	√	√	√	√	√	√	√	√	√	√	√	√	√		R-EVER4-KIT-O-RING				
CANDADO																											√	√	√	√	√	√	√	√	√	√	√		R-EVER4-CANDADO			
SOPORTE INFERIOR	√	√	√	√	√	√	√	√	√	√	√	√	√	√	√	√	√	√	√	√	√	√	√	√	√												R-EVER4-SOP-INF-1					
																												√	√	√	√	√	√	√	√	√	√	√		R-EVER4-SOP-INF-2		
KIT DE BUJES	√	√	√	√																																			R-EVER4-KIT-BUJE1			
						√	√	√	√	√	√	√	√	√	√	√	√	√	√	√	√	√	√	√	√													R-EVER4-KIT-BUJE2				
																											√	√	√	√	√	√	√	√	√	√	√	√		R-EVER4-KIT-BUJE3		
CUÑA																											√	√	√	√	√	√	√	√	√	√	√	√		R-EVER4-CUÑA		
SOPORTE SUPERIOR	√	√	√	√	√	√	√	√	√	√	√	√	√	√	√	√	√	√	√	√	√	√	√	√	√													R-EVER4-SOP-SUP-1				
																											√	√	√	√	√	√	√	√	√	√	√	√	√		R-EVER4-SOP-SUP-2	
VALVULA DE ALIVIO	√	√	√	√	√	√	√	√	√	√	√	√	√	√	√	√	√	√	√	√	√	√	√	√	√	√	√	√	√	√	√	√	√	√	√	√	√	√		R-EVER4-VALV-AL		
RETEN	√	√	√	√	√	√	√	√	√	√	√	√	√	√	√	√	√	√	√	√	√	√	√	√	√	√	√	√	√	√	√	√	√	√	√	√	√	√	√		R-EVER4-RETEN	
TAPA SUPERIOR	√	√	√	√	√	√	√	√	√	√	√	√	√	√	√	√	√	√	√	√	√	√	√	√	√	√	√	√	√	√	√	√	√	√	√	√	√	√	√		R-EVER4-TAPA	
BIRLO	√	√	√	√	√	√	√	√	√	√	√	√	√	√	√	√	√	√	√	√	√	√	√	√	√	√	√	√	√	√	√	√	√	√	√	√	√	√	√		R-EVER4-BIRLO	
DESARENADOR	√	√	√	√	√	√	√	√	√	√	√	√	√	√	√	√	√	√	√	√	√	√	√	√	√	√	√	√	√	√	√	√	√	√	√	√	√	√	√		R-EVER4-DESARENADO	
CABLE CONECTOR	√	√	√	√																																				R-EVER4-CCONEC-1		
						√	√	√	√	√	√	√	√	√	√	√																								R-EVER4-CCONEC-2		
																			√	√	√	√	√	√	√	√														R-EVER4-CCONEC-3		
																												√	√	√	√	√	√	√	√	√	√	√	√	√	√	

REFACCIÓN	TASA2 13220H	TASA2 23220H	TASA2 33230H	TASA2 43220H	TASA2 53220H	TASA2 7.53220H	TASA2 103220H	TASA2 153220H	TASA2 23440H	TASA2 33440H	TASA2 53440H	TASA2 7.53440H	TASA2 103440H	TASA2 153440H	TASA2 203440H	TASA2 303440H	CÓDIGO
CONTACTOR	√	√							√	√							EW-CR-09-M
			√								√						EW-CR-12-M
				√	√							√					EW-CR-18-M
						√							√	√			EW-CR-25-M
							√								√		EW-CR-32-M
								√								√	EW-CR-40-M
CONTACTOS AUXILIARES	√	√	√	√	√	√	√		√	√	√	√	√	√	√		EW-XG-F-11
								√								√	EW-XG2-L-11
GUARDAMOTOR	√								√								EW-GM-04
		√								√						√	EW-GM-6.3
			√								√						EW-GM-10
				√								√					EW-GM-14
					√								√				EW-GM-18
						√								√			EW-GM-23
							√								√		EW-GM-32
								√								√	EW-GM-40
LED	√	√	√	√	√	√	√	√	√	√	√	√	√	√	√	√	EW-LED-R230
	√	√	√	√	√	√	√	√	√	√	√	√	√	√	√	√	EW-LED-V230
SELECTOR	√	√	√	√	√	√	√	√	√	√	√	√	√	√	√	√	EW-SELECTOR-3P

REFACCIÓN	MSAE6 53230	MSAE6 53460	MSAE6 7 53230	MSAE6 7 53460	MSAE6 103230	MSAE6 103460	MSAE6 153230	MSAE6 153460	MSAE6 203230	MSAE6 203460	MSAE6 253230	MSAE6 253460	MSAE6 303230	MSAE6 303460	MSAE6 403460	MSAE6 503460	MSAE6 603460	CÓDIGO
BASE PARA MOTOR	√	√	√	√	√	√	√	√	√	√	√	√	√	√	√	√	√	R-EVER6-BASE
BIRLO PARA SOPORTE INFERIOR	√	√	√	√	√	√	√	√	√	√	√	√	√	√	√	√	√	R-EVER6-BIRLO-SI
CAJA DE AJUSTE	√	√	√	√	√	√	√	√	√	√	√	√	√	√	√	√	√	R-EVER6-CAJUSTE
CABLE CONECTOR	√	√	√	√	√	√	√	√	√	√	√	√	√	√	√	√	√	R-EVER6-CCONEC
CUÑA	√	√	√	√	√	√	√	√	√	√	√	√	√	√	√	√	√	R-EVER6-CUÑA
DESARENADOR	√	√	√	√	√	√	√	√	√	√	√	√	√	√	√	√	√	R-EVER6-DESARENADO
DIAFRAGMA	√	√	√	√	√	√	√	√	√	√	√	√	√	√	√	√	√	R-EVER6-DIAFRAGMA
CONJUNTO EMPUJE	√	√	√	√	√	√	√	√	√	√	√	√	√	√	√	√	√	R-EVER6-EMPUJE
KIT DE BUJES	√	√	√	√	√	√	√	√	√	√	√	√	√	√	√	√	√	R-EVER6-KIT-BUJE
SELLO MECANICO	√	√	√	√	√	√	√	√	√	√	√	√	√	√	√	√	√	R-EVER6-SELLAMEC
SOPORTE INFERIOR	√	√	√	√	√	√	√	√	√	√	√	√	√	√	√	√	√	R-EVER6-SOP-INF
SOPORTE SUPERIOR	√	√	√	√	√	√	√	√	√	√	√	√	√	√	√	√	√	R-EVER6-SOP-SUP
TORNILLO DE AJUSTE	√	√	√	√	√	√	√	√	√	√	√	√	√	√	√	√	√	R-EVER6-TORN-CA
TORNILLO DE SUJECIÓN	√	√	√	√	√	√	√	√	√	√	√	√	√	√	√	√	√	R-EVER6-TORN-SUJ



REFACCIÓN	ENERWELL-G1800I	CÓDIGO
MANIVELA DE SISTEMA DE ARRANQUE 1.8KW I	√	R-EWG18I-MANSIA
INTERRUPTOR 3 EN 1	√	R-EWG18I-INT3EN1
PUENTE RECTIFICADOR	√	R-EWG18I-PTRECT
PROTECCIÓN	√	R-EWG18I-PROTEC
BASE CLAVIJA	√	R-EWG18I-BCLAVIJA
INTERRUPTOR DE ENCENDIDO	√	R-EWG18I-INTENC
TANQUE DE COMBUSTIBLE	√	R-EWG18I-TNQCOM
MOTOR	√	R-EWG18I-MOTOR
MODULO INVERTER	√	R-EWG18I-MODINV
CUBIERTA DE ROTOR	√	R-EWG18I-CUBROT
ESTATOR	√	R-EWG18I-ESTATOR
ROTOR	√	R-EWG18I-ROTOR
CARBURADOR PARA GENERADOR 1.8KW	√	R-EWG18I-CARBU
EMPAQUE DE CARBURADOR	√	R-EWG18I-EMPCARB
EMPAQUE DE MOFLE	√	R-EWG18I-EMPMOF
MOFLE	√	R-EWG18I-MOFLE
SISTEMA DE ARRANQUE PARA GENERADOR 1.8KW	√	R-EWG18I-SISAR

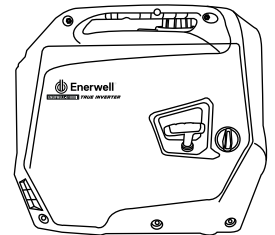
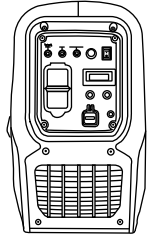

REFACCIÓN	ENERWELL-G3000I	CÓDIGO
MOTOR	√	R-EWG30I-MOTOR
EMPAQUE DE MOFLE	√	R-EWG30I-EMPMOF
MOFLE	√	R-EWG30I-MOFLE
ARNÉS DE CABLEADO	√	R-EWG30I-ARNCABLE
AMORTIGUADOR IZQUIERDO	√	R-EWG30I-AMORTIZ
AMORTIGUADOR DERECHO	√	R-EWG30I-AMORTDE
CARGADOR	√	R-EWG30I-CARG
TANQUE DE COMBUSTIBLE	√	R-EWG30I-TNQCOM
INDICADOR DE ACEITE	√	R-EWG30I-INDACE
FILTRO DE COMBUSTIBLE	√	R-EWG30I-FILCOMB
BASE DE CLAVIJA	√	R-EWG30I-BCLAVIJA
VOLTIMETRO	√	R-EWG30I-VOLTIM
INTERRUPTOR	√	R-EWG30I-INTERRUP
INTERRUPTOR DE ARRANQUE	√	R-EWG30I-INTERAR
MODULO INVERTER	√	R-EWG30I-MODINV
SISTEMA DE ARRANQUE	√	R-EWG30I-SISAR
MARCHA	√	R-EWG30I-MARCHA
CARBURADOR	√	R-EWG30I-CARBU
EMPAQUE INSULADO PARA CARBURADOR	√	R-EWG30I-EMPINSC

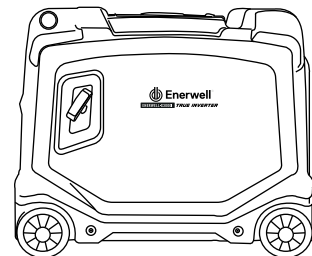
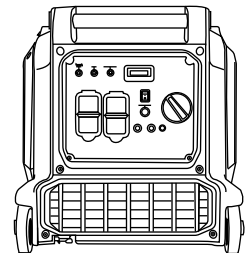

REFACCIÓN	ENERWELL-G1000	CÓDIGO
EMPAQUE DE MOFLE	√	R-EWG10-EMF
MOFLE	√	R-EWG10-MFL
VOLTÍMETRO	√	R-EWG10-VLT
TERMINAL DE CORRIENTE DIRECTA	√	R-EWG25-TERM
PROTECCIÓN	√	R-EWG10-PROT
CLAVIJA AMERICANA	√	R-EWG10-CLAV
TANQUE	√	R-EWG10-TAN
MOTOR	√	R-EWG10-MOT
ESTATOR Y ROTOR	√	R-EWG10-ESTROT
REGULADOR AVR	√	R-EWG10-AVR
ESCOBILLAS	√	R-EWG10-ESCOB
PUENTE RECTIFICADOR	√	R-EWG18I-PTRECT
SISTEMA DE ARRANQUE	√	R-EWG10-SISAR
EMPAQUE DE CARBURADOR	√	R-EWG10-EMPCB
EMPAQUE INSULADOR DE CARBURADOR	√	R-EWG10-EMPIC
CARBURADOR	√	R-EWG10-CARB
EMPAQUE DE FILTRO DE AIRE	√	R-EWG10-EMPFA

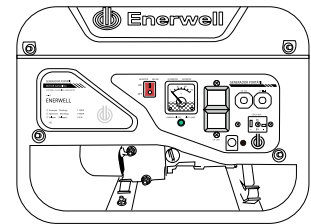
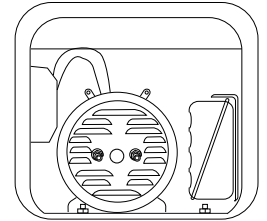

REFACCIÓN	ENERWELL-G2500	CÓDIGO
MOTOR	√	R-EWG25-MOT
CABLE DE MOTOR TIPO 1	√	R-EWG25-CMT1
CABLE DE MOTOR TIPO 2	√	R-EWG25-CMT2
EMPAQUE DE MOFLE	√	R-EWG25-EMF
MOFLE	√	R-EWG25-MFL
ESTATOR Y ROTOR 2.5KW	√	R-EWG25-ESTROT
ESCOBILLAS	√	R-EWG10-ESCOB
PUENTE RECTIFICADOR	√	R-EWG18I-PTRECT
REGULADOR AVR	√	R-EWG25-AVR
CUBIERTA DE GENERADOR 2.5KW	√	R-EWG25-CUB
TANQUE DE COMBUSTIBLE	√	R-EWG25-TAN
VOLTÍMETRO	√	VOLTIM-0103-001
INTERRUPTOR HIDRÁULICO	√	R-EWG25-INT
PROTECCIÓN	√	R-EWG10-PROT
TERMINAL	√	R-EWG25-TERM

REFACCIÓN	ENERWELL-G5000	ENERWELL-G8000	CÓDIGO
MOTOR PARA GENERADOR 5KW	√		R-EWG50-MOT
MOTOR PARA GENERADOR DE 8KW		√	R-EWG80-MOT
CABLE DE MOTOR 1 DE GENERADOR 5-8KW	√	√	R-EWG25-CMT1
CABLE DE MOTOR 2 DE GENERADOR 5-8KW	√	√	R-EWG25-CMT2
EMPAQUE DE MOFLE PARA GENERADOR DE 5-8KW	√	√	R-EWG50/80-EMF
MOFLE PARA GENERADOR DE 5KW	√		R-EWG50-MFL
MOFLE PARA GENERADOR DE 8KW		√	R-EWG80-MFL
TANQUE DE COMBUSTIBLE PARA GENERADOR 5-8KW	√	√	R-EWG50/80-TAN
ROTOR DE GENERADOR 5KW	√		R-EWG50-ROT
ROTOR DE GENERADOR 8KW		√	R-EWG80-ROT
ESTATOR PARA GENERADOR DE 5KW	√		R-EWG50-EST
ESTATOR PARA GENERADOR DE 8KW		√	R-EWG80-EST
SOPORTE DEL MOTOR PARA GENERADOR 5-8 KW	√	√	R-EWG50/80-SOPM
KW ESCOBILLAS PARA GENERADOR 5-8KW	√	√	R-EWG50/80-ESCOB
PUENTE RECTIFICADOR PARA GENERADOR 5-8KW	√	√	R-EWG18I-PTRECT
REGULADOR AVR PARA GENERADOR 5KW	√		R-EWG50-AVR
REGULADOR AVR PARA GENERADOR 8KW		√	R-EWG80-AVR
INTERRUPTOR DE ARRANQUE CON LLAVE PARA VOLTÍMETRO DE GENERADOR 5-8KW	√	√	R-EWG50/80-INTA
INTERRUPTOR 1 DE GENERADOR 5KW	√		R-EWG50-INT1
INTERRUPTOR 2 DE GENERADOR 8KW		√	R-EWG80-INT2
BASE DE CLAVIJA PARA GENERADOR 5-8KW	√	√	R-EWG10-CLAV
TERMINALES PARA GENERADOR 5-8KW	√	√	R-EWG25-TERM
PROTECTOR PARA GENERADOR 5-8KW	√	√	R-EWG10-PROT

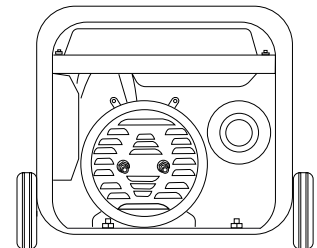
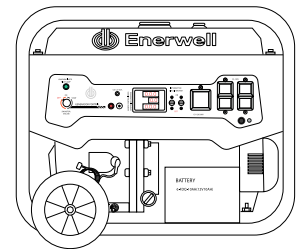

REFACCIÓN	Modelos de Arrancador														CÓDIGO				
	AEWTP 1.6-2.5/220	AEWTP 2.5-4/220	AEWTP 4-6/220	AEWTP 5.5-8/220	AEWTP 7-10/220	AEWTP 9-13/220	AEWTP 12-18/220	AEWTP 17-25/220	AEWTP 23-32/220	AEWTP 1.6-2.5/440	AEWTP 2.5-4/440	AEWTP 4-6/440	AEWTP 5.5-8/440	AEWTP 7-10/440		AEWTP 9-13/440	AEWTP 12-18/440	AEWTP 17-25/440	AEWTP 23-32/440
BOBINAS	√	√	√	√	√	√	√												EW-ZC-T1-M
							√	√											EW-ZC-T2-M
									√	√	√	√	√	√	√				EW-ZC-T1-R
																	√	√	EW-ZC-T2-R
CONTACTOR	√	√	√																EW-CR-06-M
			√																EW-CR-09-M
				√															EW-CR-12-M
					√	√													EW-CR-18-M
							√												EW-CR-25-M
								√											EW-CR-32-M
									√	√	√								EW-CR-06-R
												√							EW-CR-09-R
													√						EW-CR-12-R
														√	√				EW-CR-18-R
																√			EW-CR-25-R
																	√		EW-CR-32-R
PULSADOR	√	√	√	√	√	√	√	√	√	√	√	√	√	√	√	√	√	√	EW-B-P-VERDE
	√	√	√	√	√	√	√	√	√	√	√	√	√	√	√	√	√	√	EW-B-P-ROJO
RELEVADOR	√								√										EW-R-2.5
		√								√									EW-R-04
			√								√								EW-R-06
				√								√							EW-R-08
					√								√						EW-R-10
						√								√					EW-R-13
							√								√				EW-R-18
								√								√			EW-R-25
									√								√		EW-R-32

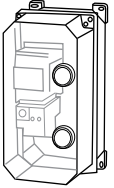

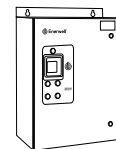

REFACCIÓN	AEVTR-10-30/220	AEVTR-30-55/220	AEVTR-55-80/220	AEVTR-80-135/220	AEVTR-135-160/220	AEVTR-10-20/440	AEVTR-20-42/440	AEVTR-42-70/440	AEVTR-70-80/440	AEVTR-80-100/440	AEVTR-100-135/440	AEVTR-135-200/440	AEVTR-200-260/440	AEVTR-260-300/440	CÓDIGO
AUTOTRANSFORMADOR	√	√													AUTOTRANSF-20-230
			√												AUTOTRANSF-30-230
				√											AUTOTRANSF-50-230
					√										AUTOTRANSF-60-230
						√									AUTOTRANSF-20-440
							√								AUTOTRANSF-30-440
								√							AUTOTRANSF-50-440
									√						AUTOTRANSF-60-440
										√					AUTOTRANSF-75-440
											√				AUTOTRANSF-100-440
												√			AUTOTRANSF-150-440
													√		AUTOTRANSF-200-440
													√	AUTOTRANSF-300-440	
BOBINA	√	√				√	√								EW-ZC-T2-F
			√				√	√	√		√				EW-ZC-T3-F
		√	√	√	√			√	√	√	√	√	√		EW-ZC-T4-F
				√						√	√	√	√	√	EW-ZC-T5-F
					√							√	√		EW-ZC-T6-F
													√		EW-ZC-T7-F
														√	EW-ZC-T8-F
BASE DE RELEVADOR	√	√	√	√	√	√	√	√	√	√	√	√	√	EW-BRE-16	
CLEMA	√	√	√			√	√	√	√						CLEMA 1P 125 AMP
				√	√					√	√	√			CLEMA-1P-T-232A
													√	√	CLEMA-1P-T-415A
CONTACTOR 127 V	√	√				√	√								EW-CR-25-F
	√	√				√	√	√	√						EW-CR-32-F
			√				√	√	√		√				EW-CR-50-F
		√	√	√	√			√	√	√	√	√	√		EW-CR-85-F
			√	√	√										EW-CR-100-F
										√				√	EW-CR-115-F
				√							√	√	√		EW-CR-150-F
					√										EW-CR-185-F
												√		√	EW-CR-225-F
													√		EW-CR-265-F
													√	EW-CR-400-F	
ePROTECT	√	√	√	√	√	√	√	√	√	√	√	√	√	EW-PROTECT	
INTERRUPTOR DE CONTROL	√	√				√	√								EW-IT1P4A
			√	√				√	√	√	√				EW-IT1P6A
					√							√	√		EW-IT1P10A
													√	√	EW-IT1P16A

REFACCIÓN	CÓDIGO														
	AEVTR-10-30/220	AEVTR-30-55/220	AEVTR-55-80/220	AEVTR-80-135/220	AEVTR-135-160/220	AEVTR-10-29/440	AEVTR-29-42/440	AEVTR-42-70/440	AEVTR-70-80/440	AEVTR-80-100/440	AEVTR-100-135/440	AEVTR-135-200/440	AEVTR-200-260/440	AEVTR-260-330/440	
INTERRUPTOR TERMOMAGNÉTICO	√	√				√	√	√							EW-ITCX3P-100E
			√						√	√					EW-ITCX3P-160E
				√	√							√			EW-ITCX3P-250E
													√	√	EW-ITCX3P-400E
														√	EW-ITCX3P-630E
LED	√	√	√	√	√	√	√	√	√	√	√	√	√	√	EW-LED-V127
	√	√	√	√	√	√	√	√	√	√	√	√	√	√	EW-LED-R127
	√	√	√	√	√	√	√	√	√	√	√	√	√	√	EW-LED-AM127
PULSADOR	√	√	√	√	√	√	√	√	√	√	√	√	√	√	EW-B-P-VERDE
	√	√	√	√	√	√	√	√	√	√	√	√	√	√	EW-B-P-ROJO
RELEVADOR DE CONTROL	√	√	√	√	√	√	√	√	√	√	√	√	√	√	EW-RE16A-127VCA
RELEVADOR DE TIEMPO	√	√	√	√	√	√	√	√	√	√	√	√	√	√	EW-TR-2R16-ED
TAPA PLÁSTICA	√	√	√	√	√	√	√	√	√	√	√	√	√	√	EW-E-TPD1
TRANSFORMADOR DE CONTROL	√					√									EW-TC-42/1V-50VA
		√					√	√							EW-TC-42/1V-75VA
			√	√					√	√	√				EW-TC-42/1V-100VA
					√							√	√		EW-TC-42/1V-150VA
														√	EW-TC-42/1V-300VA
TRANSFORMADOR DE CORRIENTE	√	√	√	√	√	√	√	√	√	√	√	√	√	√	EW-TCT-1

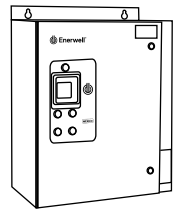



REFACCIONES

LÁMPARAS DELUX

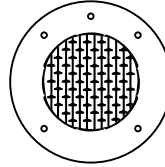

REFACCIÓN	DLX-5N- B-12W-12A	DLX-5N- C-12W-12A	DLX-9-C- 7W-12A	DLX-9-B- 12W-12A	DLX-9-C- 12W-12A	DLX-9-C- 18W-12A	DLX-9-C- 23W-12A	DLX-10N-B- 18W-12A	DLX-10N-B- 50W-12A	DLX-10N-C- 33W-12A	DLX-10N-C- 33W-12D	CÓDIGO
KIT MANGUERA								√	√	√	√	R-DLXKM10N
LAMINA SUPERIOR								√	√	√	√	R-DLX-10LAN-LAMINA
NICHO								√	√	√	√	R-DLX-10N
NICHO	√	√										R-DLX-5N
LAMINA TORNILLO			√	√	√	√	√					R-DLX-9-C-LAMINA



REFACCIONES

CASCADAS WATERFALL LED

REFACCIÓN	WF-LED -12-6-T	WF-LED -18-6-T	WF-LED -24-6-T	WF-LED -36-6-T	WF-LED -48-6-T	CÓDIGO
CABLE DE ALIMENTACIÓN 30M	√	√	√	√	√	R-WFLL-CAB-ALIM30M
RED PLAST. CONEX. DE CASCADA	√	√	√	√	√	R-WFLL-RED
KIT 4TAPAS P/CASCADA 12",18",24",36",48"	√	√	√	√	√	R-WFLL-KITTAPP/CAS



REFACCIÓN	BURBUJEADOR 4"	BURBUJEADOR 8"	CÓDIGO
KIT LENTE	√		KITLENTEBURB4
KIT CUBIERTA PROTECTORA	√		KITCUBIERTABURB4
CABLE DESCONEXIÓN RÁPIDA	√		CABLEDRBURB4/15M
CUERPO BURBUJEADOR 8" (SIN LED)		√	CUERPOBURBLED8

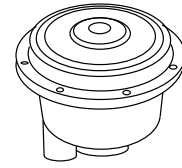

REFACCIONES CALENTADOR PARA HIDROMASAJE SERIE CALORE

REFACCIÓN	CALORE1000-1127	CÓDIGO
KIT RACOR	√	R-CALORE-KITRAC1.5

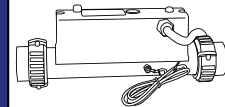

REFACCIONES TIMER MECÁNICO DE VOLTAJE DUAL SERIE KROSS

REFACCIÓN	KROSS-TM-VD-12A-G	CÓDIGO
CONJ. DE BATERÍA	√	R-KROSS-KITBAT

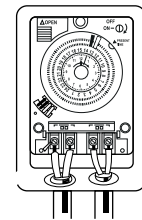

REFACCIONES FILTROS CARTUCHO PANDA

REFACCIÓN	012-014- A-001	012-014- A-002	012-014- A-003	012-014- A-004	CÓDIGO
TAPÓN DREN	√	√	√	√	R-FC-TAPONDREN
TAPA C/ANILLO	√	√	√	√	R-FC-TAPA
O-RING ANILLO	√	√	√	√	R-FC-ORING
BLOQUEO DE ANILLO	√	√	√	√	R-FC-BLOANILLO
TAPÓN INFERIOR	√	√	√	√	R-FC-TAPONINF
REPUESTO 25GPM	√				012-014-D-001
REPUESTO 35GPM		√			012-014-D-002
REPUESTO 50GPM			√		012-014-D-003
REPUESTO 70 GPM				√	012-014-D-004

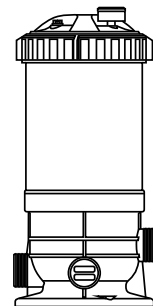

REFACCIONES ROBOT LIMPIADOR AUTOMÁTICO

REFACCIÓN	PA-ROBOT-RT-1-18M	CÓDIGO
BOLSA FILTRO	√	R-PA-ROBOT-BOLFILTR
KIT DE MANTENIMIENTO	√	R-PA-ROBOT-KITMAN
KIT SOPORTE RODILLOS	√	R-PA-ROBOT-KITSR
CONJUNTO CABLE	√	R-PA-ROBOT-CONJCBL
TARJETA CONTROLADOR	√	R-PA-ROBOT-TCTRL

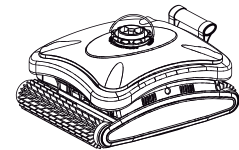

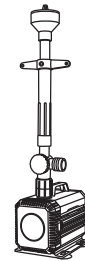

REFACCIÓN	BABY8	BABY18	BABY30	BABY55	CÓDIGO
BUJE	√				R-BABY8-BUJE
		√			R-BABY18-BUJE
			√		R-BABY30-BUJE
				√	R-BABY55-BUJE
EJE	√				R-BABY8-EJE
		√			R-BABY18-EJE
			√		R-BABY30-EJE
				√	R-BABY55-EJE
FILTRO	√				R-BABY8-FILTRO
		√			R-BABY18-FILTRO
			√		R-BABY30-FILTRO
				√	R-BABY55-FILTRO
O-RING	√				R-BABY8-ORING
PIE DE BOMBA	√	√			R-BABY18-ORING
	√	√			R-BABY8-PIE
ROTOR	√				R-BABY8-ROTOR
		√			R-BABY18-ROTOR
			√		R-BABY30-ROTOR
				√	R-BABY55-ROTOR
TAPA DEL FILTRO	√				R-BABY8-TAPFIL
		√			R-BABY18-TAPFIL
TAPA DEL MOTOR	√				R-BABY8-TAPM
		√			R-BABY18-TAPM
			√		R-BABY30-TAPM
				√	R-BABY55-TAPM

REFACCIONES
FILTROS PANDA (PLÁSTICO REFORZADO)

REFACCIÓN	FPD14T	FPD26T	FPD31T	CÓDIGO
VÁLVULA 6V	√			R-FPDT14-VALVULA
		√		012-007-A-001
EMPAQUE TANQUE	√		√	R-FPD31-VALV6V
		√		R-FPD14-EMPATANQ
ABRAZADERA PARA VÁLVULA	√		√	012-007-D-016
			√	012-007-D-016
CREPINAS		√	√	R-FPD14-ABRA
		√	√	012-007-D-015
KIT COLECTOR	√		√	R-FPD26-CREPINAS
		√		R-FPD31-CREPINAS
		√		R-FPD14-KITCOLEC
KIT DE DRENADO	√		√	R-FPD26-KITCOLEC
		√		R-FPD31-KITCOLEC
		√		R-FPD14-KITDREN
BASE PARA TANQUE	√		√	R-FPD26-KITDREN
		√		R-FPD31-KITDREN
			√	R-FPD14-BASEFILT
MEDIA VÁLVULA	√		√	R-FPD26-BASEFILT
		√		R-FPD31-BASEFILT
			√	R-FPD14-MEDIAVALV
RACOR	√		√	012-007-D-017
		√		R-FPD31-MEDIAVALV
			√	R-FPDT14-KITRACOR
ROTOR	√		√	012-007-D-035
		√		R-FPD14-KITROTVAL
			√	012-007-D-019
		√	R-FPD31-KITROT-VAL	

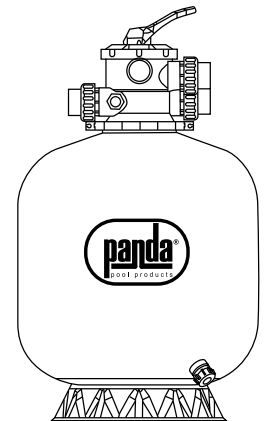

REFACCIÓN	FPP14T	FPP28T	FPF35T	FPF40L	FPF48L	FPF55L	CÓDIGO
CONJUNTO DE DRENADO			√	√	√	√	R-FPP-CONJUNTODREN
BASE PARA FILTRO	√						R-FPP14T-BASEFILT
		√					R-FPP28T-BASEFILT
			√				R-FPP35T-BASEFILT
				√			R-FPP40L-BASEFILT
					√		R-FPP48L-BASEFILT
						√	R-FPP55L-BASEFILT
CREPINA DE FILTRADO		√					R-FPP28T-CREPINA
				√			R-FPP40L-CREPINA
					√	√	R-FPP48-55L-CREPIN
KIT DE SOPORTE, TUBO Y COLECTOR		√					R-FPP28T-KITCOLECT
			√				R-FPP35T-KITCOLECT
DIFUSOR				√	√	√	R-FPFL-DIFUSOR

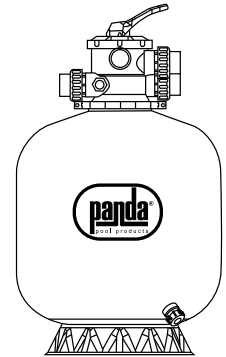

REFACCIÓN	FPD16T	FPD19T	FPD24T	CÓDIGO
BASE PARA FILTRO	√			012-007-D-001
BASE PARA FILTRO		√	√	012-007-D-002
CONJUNTO DE DRENADO	√	√	√	012-007-D-003
CREPINA ESTÁNDAR	√	√		012-007-D-004
CREPINA ESTÁNDAR			√	012-007-D-005
CONJUNTO DE PURGA DE AIRE	√	√	√	012-007-D-008
TUBO CENTRAL	√			012-007-D-012
		√		012-007-D-013
			√	012-007-D-014
ABRAZADERA PARA VÁLVULA	√	√	√	012-007-D-015
EMPAQUE TANQUE	√	√	√	012-007-D-016
VÁLVULA 6 VÍAS	√	√	√	012-007-A-001
MEDIA VÁLVULA	√	√	√	012-007-D-017
JUEGO ORING FILTRO	√	√	√	012-007-D-018
ROTOR VÁLV. /EMPAQUE ARAÑA	√	√	√	012-007-D-019
KIT RESORTE CON RONDANAS	√	√	√	012-007-D-020
BASE PARA VÁLVULA 6 VÍAS	√	√	√	012-007-D-021
CUERPO PARA VÁLVULA	√	√	√	012-007-D-022
MIRILLA Y O-RING	√	√	√	012-007-D-023
RESORTE PARA VÁLVULA	√	√	√	012-007-D-024
KIT DE O-RING TAPA Y CUERPO	√	√	√	012-007-D-026
O-RING PARA ROTOR	√	√	√	012-007-D-027
PALANCA PARA VÁLVULA	√	√	√	012-007-D-029
ARANDELA DE PALANCA	√	√	√	012-007-D-031
ARANDELA DE ROTOR	√	√	√	012-007-D-032
RACOR	√	√	√	012-007-D-035

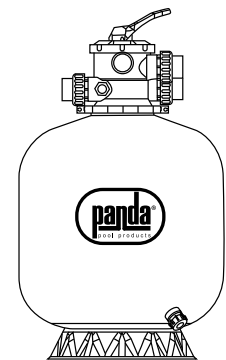

REFACCIÓN	MARB-36T- FB-6V	MARB-40L- FB-6V	MARB-48L- FB-6V	MARB-56L- FB-6V	CÓDIGO
COLECTOR	√				R-MARB-COLEC36"-S
		√			R-MARB-KITCOLEC40L
			√		R-MARB-KITCOLEC48L
				√	R-MARB-KITCOLEC56L
CONJUNTO DE DRENADO	√	√	√	√	R-MARB-CONJDRENADO
CREPINAS DE FILTRADO (8 PIEZAS)	√				R-MARB-CREP-SUP36"
		√			R-MARB-CREP-LAT40"
			√		R-MARB-CREP-LAT48"
				√	R-MARB-CREP-LAT56"
DISTRIBUIDOR SUPERIOR		√	√	√	R-MARB-BRETORNO-L
EMPAQUE ARAÑA	√				R-MARB-KITRPT-VSUP
EMPAQUE DE CUBIERTA		√	√	√	R-MARB-KITROT-VLAT
EMPAQUE VALVULA FILTRO	√				R-MARB-ETVSUP2"
KIT DE RACOR CON CODO DE 2"		√	√	√	R-MARB-RACCODO-L
KIT MEDIA VALVULA	√				R-MEDVALV-SUP
KIT RACOR	√				R-MARB-KITRAC-VSUP
		√	√	√	R-MAR-KITRAC-VLAT
O'RING PARA EL SELLADO DEL COLECTOR	√				R-MARB-ORING/COLEC
TAPA		√	√	√	R-MARB-TAPA-VLAT
TAPÓN DE PURGADO		√	√	√	R-MARB-TPURG
VÁLVULA LATERAL		√	√	√	R-MARB-VALVLAT2"
VÁLVULA TOP	√				R-MARB-VALVSUP2"

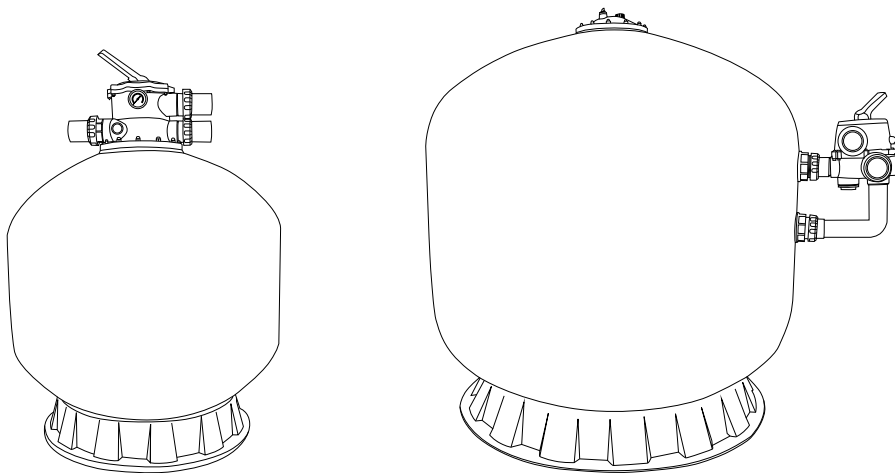



REFACCIONES

CLORADORES SALINOS DESTINADOS A LA DESINFECCIÓN PROFESIONAL DE LA PISCINA

REFACCIÓN	SMARTCL15127	SMARTCL25127	SMARTCLPLUSPH5230	SMARTCLPLUSPH25230	SMARTCLPLUSPH35230	SMARTCLPLUS50230	SMARTCLPLUS70230	SMARTCLPLUS100230	SMARTCLPLUS200230	SMARTCLPLUS250230	SMARTCLPLUS500230	SMARTCLPLUS750230	SMARTCLPLUS1000230	CÓDIGO
RACOR CEMENT-ROSCA HEMB 90-3"								√						R-SMARTCL100-RACOR
ABRAZADERA			√	√	√	√								R-ABRAZADERASMP-50
	√	√												R-SMARTCL-ABRAZAD
CABLE FLEX	√	√	√	√	√	√	√	√	√	√	√	√	√	R-CLS-FLEX
CIRCUITO 170X60MM			√											SMARTCLPLUS-TEC
DISPLAY			√	√	√	√	√	√	√	√	√	√	√	SMARTCLPLUS-DISP
SOLUCIÓN PATRON PH4	√	√												R-SMARTCL-SP-PH4
	√	√												R-SMARTCL-SP-PH7
	√	√												R-SMARTCL-SP-ORP
JUNTA TORICA P. VASO CELULA	√	√	√	√	√									SMARTCL-JTVC
TARJETA DE CONTROL	√	√												SMARTCL-TCTRL
TARJETA DE POTENCIA	√		√											SMARTCL-TPOT10/15G
		√		√										SMARTCL-TPOT20/25G
		√		√										SMARTCLPLUS-TPOT25
					√									SMARTCLPLUS-TPOT35
								√						SMARTCLPLUS-TPOTA
CENTRALINA	√													012-002-E-214
		√												012-002-E-215
														012-002-E-216
	√		√											012-002-E-217
		√		√										012-002-E-218
					√									012-002-E-219
						√								012-002-E-213
							√							012-002-E-211
								√						012-002-E-210
									√					012-002-E-209
										√				012-002-E-208
											√			012-002-E-207
												√		012-002-E-212
CÉLULA	√		√											R-CEULASMCL15
		√		√										R-CEULASMCL25
				√										R-CEULASMCL35
					√									R-CEULASMCL50
						√								R-CEULASMCL70
							√							R-CEULASMCL100
								√						R-CEULASMCL200
									√					R-CEULASMCL250
VASO CELULA	√	√	√	√	√									R-VASOCELULASMCL1
						√	√							R-VASOCELULASMCL50
								√						R-VASOCELULASMCL2
SONDA DE FLUJO			√	√	√	√	√	√	√	√	√	√	√	SMARTCLPLUS-SFLUJO
SONDA DE TEMPERATURA			√	√	√	√	√	√	√	√	√	√	√	SMARTCLPLUS-STEMP
SONDA PH			√	√	√	√	√	√	√	√	√	√	√	SMARTCLPLUS-SPH
SONDA REDOX			√	√	√	√	√	√	√	√	√	√	√	SMARTCLPLUS-SREDOX
KIT SONDA CONDUCTIVIDAD			√	√	√	√	√	√	√	√	√	√	√	SMARTCLPLUS-SCOND
PORTA SONDAS	√	√												R-SMARTCL-PSONDA



PURIKOR®

Cuida el agua, protege la vida

REFACCIONES DISPENSADOR DE AGUA FRÍA Y AL TIEMPO

REFACCIÓN	PK-LILI	PK-LILI-RO	PK-IRIS	PK-IRIS-RO	CÓDIGO
PORTA MEMBRNA OS 400 GPD PK-LILI/IRIS		√		√	R-PK-PORTAMEMRO
PORTAFILTRO TRANSPARENTE PK-LILI/IRIS		√		√	R-PK-PORTAFILTR
PORTAFILTRO BLANCO PK-LILI/IRIS		√		√	R-PK-PORTAFILBL
CLIP PORTA MEMBRANA RO PK-LILI/IRIS		√		√	R-PK-CLIPPORTRO
CLIP PORTA RO C/POST FILTRO PK-LILI/IRIS		√		√	R-PK-CLIPPROFIL
REDUCTOR DE FLUJO PK-LILI/IRIS		√		√	R-PK-REDUFLUJO
TERMOSTATO PK-LILI/IRIS	√	√	√	√	R-PK-TERMOST
LLAVE GANZO PK-IRIS			√	√	R-PK-IRLLAVEGA
BOTON LLAVE PK-IRIS			√	√	R-PK-IRBOTON
COMPRESOR PK-LILI/IRIS	√	√	√	√	R-PK-COMPRESOR
TANQUE PK-IRIS			√	√	R-PK-IRTANQUE
TANQUE PK-LILI	√	√			R-PK-LITANQUE
TAPA FRONTAL PK-IRIS			√	√	R-PK-IRTAPAFRONT
VALVULA ALIMENTACION 3/8"X1/2" IRIS/LI	√	√	√	√	R-PK-VALVALIM3/8
VALVULA ALIMENTACION 1/4"X1/2" IRIS/LI	√	√	√	√	R-PK-VALVALIM1/4
TRANSFORMADOR		√		√	R-PK-LI-IR-TRANS

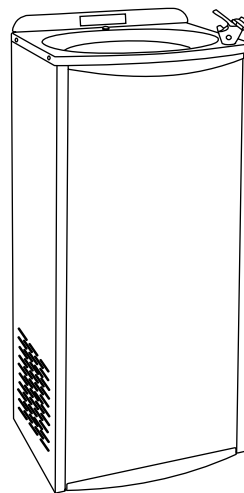
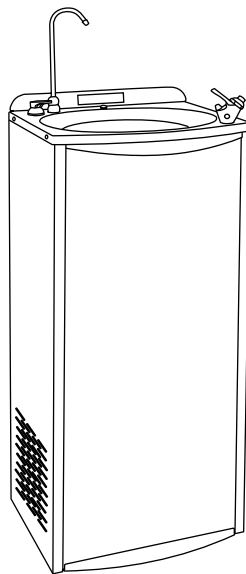
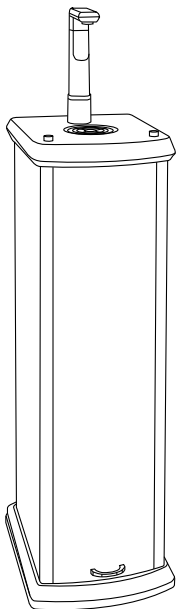

REFACCIÓN	PKHIERRO1044-1	CÓDIGO
SEGURO	√	R-PK05056044B
KIT DRENADO	√	R-PKDLFC1-7
COLECTOR SUPERIOR	√	R-PK07060024
AC/AC ADAPTOR	√	R-PK11040038
ADAPTOR 3/4" NPT	√	R-PK21319016N
O-RING	√	R-PK26010036
	√	R-PK26010143
INSERTO	√	R-PK30110004M
CONECTOR	√	R-PK-02170056P
CLIP DE BOLQUEO	√	R-PK21709003N
VÁLVULA DE SUAVIZACIÓN	√	PKVS26D-1-948

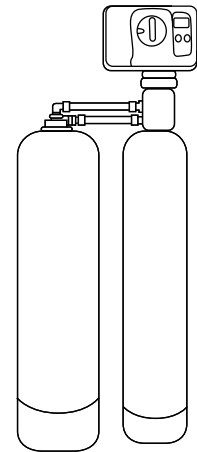

REFACCIÓN	PKTN -0948-1	PKTN -1035-1	PKTN -1054-1.5	PKTN -1248-2	PKTN -1354-2.5	PKTN -1465-3	PKTN -1665-4	PKTN -1865-5	PKTN -2162-7	PKTN -2472-10	PKTN -3072-15	PKTN -3672-20	CÓDIGO
TUBO									√	√	√	√	R-PKTN-TUBCEN50MM
TAPA INFERIOR										√	√	√	R-PKTN-TAPA4
ADAPTADOR								√					R-PKTN-REDUCCION
COLECTOR	√	√	√	√	√	√	√	√					R-PKTN-COLINF-A
COLECTOR CON 6 CREPINAS									√				R-PKTN-COLINF-B
COLECTOR CON S 12 CREPINA										√			R-PKTN-COLINF-C
											√		R-PKTN-COLINF-D
												√	R-PKTN-COLINF-E

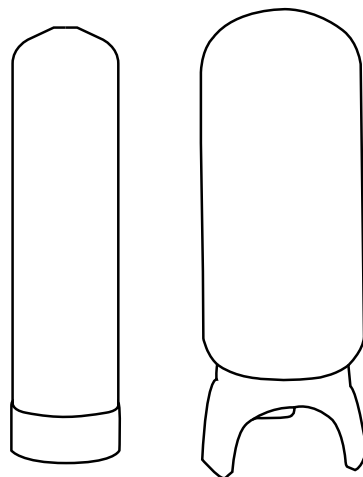

REFACCIÓN	PKUV-1-AAV-PK	PKUV-2-AAV-PK	PKUV-6-AAV-PK	PKUV-6-RAV-PK	PKUV-12-RAV-PK	PKUV-18-RAV-PH	PKUV-30-RAV-PH	PKUV-40-RAV-PH	PKUV-60-RAV-PH	PKUV-80-RAV-PH	CÓDIGO
FOCO UV	√										R-PKUV12W
		√									R-PKUV16W
			√	√							R-PKUV25W
						√					R-PKUV40W
					√						R-PKUV55W
							√	√*2	√*3	√*4	
MANGA CUARZO	√										R-PKCUARZO-1
		√									R-PKCUARZO-2
			√	√							R-PKCUARZO-6
					√						R-PKCUARZO-12
						√					R-PKCUARZO-18
							√	√*2	√*3	√*4	
BALASTRO FOCO UV	√	√	√								R-PKBALCLASSIC
				√							R-PKBAL.GOLD6
					√						R-PKBAL.GOLD12
						√					R-PKBAL.PLAT18
							√				R-PKBAL.PLAT30
								√*2	√*3	√*4	
CONECTOR FOCO UV 4 PIN.							√	√	√		R-PKUVCONEC4P
CONTADOR LAMPARA							√	√	√		R-PKUVTIMER
FUSIBLE PARA LAMP. UV							√	√	√		R-PKUVFUSIBLE
SOPORTE MONTAJE	√										R-PKUVPO1
		√	√	√	√						R-PKUVPO2
						√	√				R-PKUVSS04
SWITCH ON/OFF							√	√	√		R-PKUVSWITCH
VÁLVULA DE DRENADO							√	√	√		R-PKUVVALVDESAG
FOCO ROJO							√	√	√		R-PKUVFOCOROJO
FOCO VERDE							√	√	√		R-PKUVFOCOVERDE

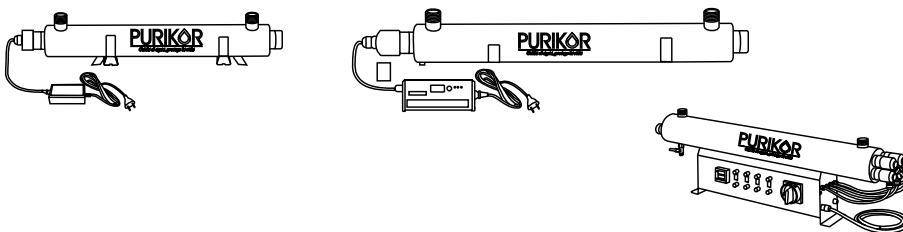

REFACCIONES PORTAFILTROS MALLA

REFACCIÓN	PKPFMALLA5X.5	CÓDIGO
FILTRO	√	PKPF-L10X.5

REFACCIÓN	PKF 1/T	PKF-2	PKF-3UV	CÓDIGO
VÁLVULA DE ALIMENTACIÓN	√			R-PK-VA-02
		√	√	R-PKMFV-01
ADAPTADOR CODO "L" (RM1/4", T1/4")		√	√	R-PK-DCC-002A
PORTA FILTRO BLANCO	√	√	√	PKPFB10X.25
CARTUCHO POLIPROPILENO		√	√	PKCPP2.5X10X5
CARTUCHO DE CARBÓN BLOCK	√	√	√	PKCCTO2.5X10X5
O-RING P/PORTAFILTRO	√	√	√	R-PKORINGPFB
LLAVE PORTAFILTRO	√	√	√	R-PK-WR-02
LLAVE DE GANSO		√	√	R-PK-GF02S
SOPORTE		√	√	R-PK-BRAF-2
NIPPLE 1/4 X 1/4		√	√	R-PK-M22
MANGUERA TUBING		√	√	PK-MANGTUBING1/4
FOCO UV 6W			√	R-PK-UV-6W
MANGA CUARZO			√	R-PK-UVMC-6W
CUERPO DE LÁMPARA INOXIDABLE			√	R-PK-GABINETEUV
TRANSFORMADOR UV 100-140V A 0.12A			√	R-PK-ADAPTADORUV
O-RING LÁMPARA UV 6W			√	R-PK-ORINGUV6W
SUJETADOR DE CAMARA DE ACERO			√	R-PK-CL-06

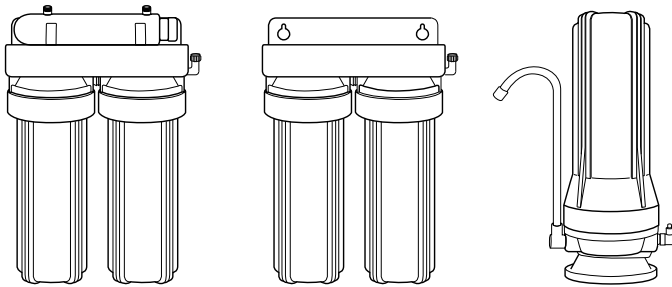

REFACCIÓN	PKUF-5	PKUF-6UV	CÓDIGO
VÁLVULA DE ALIMENTACIÓN	√	√	R-PKMFV-01
ADAPTADOR CODO "L" (RM1/4", T1/4")	√	√	R-PK-DCC-002A
PORTA FILTRO BLANCO	√	√	PKPFB10X.25
CARTUCHO POLIPROPILENO	√	√	PKCPP2.5X10X5
CARTUCHO DE CARBÓN BLOCK	√	√	PKCCTO2.5X10X5
O-RING P/PORTAFILTRO	√	√	R-PKORINGPFB
LLAVE PORTAFILTRO	√	√	R-PK-WR-02
LLAVE DE GANSO	√	√	R-PK-GF06
SOPORTE	√	√	R-PK-BRAUF-5
NIPPLE 1/4 X 1/4	√	√	R-PK-M22
MANGUERA TUBING	√	√	PK-MANGTUBING1/4
FOCO UV 6W		√	R-PK-UV-6W
MANGA CUARZO		√	R-PK-UVMC-6W
CUERPO DE LÁMPARA INOX.		√	R-PK-GABINETEUV
TRANSFORMADOR UV 100-140V A 0.12A		√	R-PK-ADAPTADORUV
CARTUCHO CARBÓN EN LINEA	√	√	PKCCAL2.5X10
O-RING LÁMPARA UV 6W		√	R-PK-ORINGUV6W
MEMBRANA	√	√	PKUF-M
CARTUCHO DE CARBÓN GRANULAR	√	√	PKCGAC2.5X10
PORTA MEMBRANA	√	√	R-PKROH-10B
ABRAZADERA DE DRENADO	√	√	R-PK-CLM-5
ADAPTADOR CODO "L" (RM1/8", T1/4")	√	√	R-PK-DCC-013A
O-RING PORTA MEMBRANA	√	√	R-PK-ORING-PM
SUJETADOR PARA PORTAMEMBRANA	√	√	R-PK-CL05
SUJETADOR PORTAMEMB./POSFIL	√	√	R-PK-CL04
SUJETADOR POSTFIL./LAMP.UV		√	R-PK-CL07
VÁLVULA DE PASO	√	√	R-PK-DCC-025

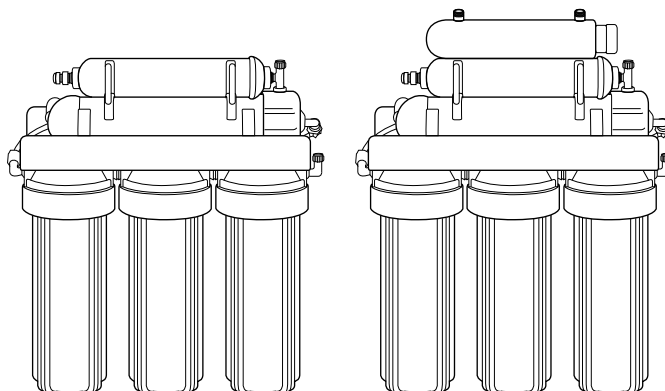

REFACCIÓN	PKRO 100-5P	PKRO 100-6UVP	PKRO 400-6UVP	CÓDIGO
CONEX. DESV. (R.M. 1/2", R.M.1/2", TUB. 1/4")	√	√	√	R-PK-MF-1
ADAPTADOR CODO "L" (RM1/4", T1/4")	√	√	√	R-PK-DCC-002A
PORTA FILTRO BLANCO	√	√	√	PKPFB10X.25
CARTUCHO POLIPROPILENO	√	√	√	PKCPP2.5X10X5
CARTUCHO DE CARBÓN BLOCK	√	√	√	PKCCTO2.5X10X5
O-RING P/PORTAFILTRO	√	√	√	R-PKORINGPFB
LLAVE PORTAFILTRO	√	√		R-PK-WR-02
LLAVE DE GANSO	√	√	√	R-PK-GF06
MEMBRANA	√	√		PKM-100G
			√	PKM-400G
BOMBA BOOSTER	√	√		R-PK-BP01-100G
			√	R-PK-BP01-400G
MANGUERA TUBING			√	PK-MANGTUBING1/2-N
	√	√		PK-MANGTUBING1/4
FOCO UV 6W		√	√	R-PK-UV-6W
MANGA CUARZO		√	√	R-PK-UVMC-6W
CUERPO DE LÁMPARA INOXIDABLE		√	√	R-PK-GABINETEUV
TRANSFORMADOR UV		√	√	R-PK-ADAPTADORUV
CARTUCHO CARBÓN EN LÍNEA	√	√	√	PKCCAL2.5X10
O-RING LÁMPARA UV		√	√	R-PK-ORINGUV6W
TRANSFORMADOR BOMBA	√	√		R-PK-ADAPTOR
			√	R-PK-ADAPTOR400G
CARTUCHO DE CARBÓN GRANULAR	√	√	√	PKCGAC2.5X10
PORTA MEMBRANA	√	√		R-PKROH-10B
			√	R-PKROH-10BB
ABRAZADERA DE DRENADO	√	√	√	R-PK-CLM-5
ADAPTADOR CODO "L" (RM1/8", T1/4")	√	√	√	R-PK-DCC-013A
O-RING PORTA MEMBRANA	√	√		R-PK-ORING-PM
SUJETADOR PARA PORTAMEMBRANA	√	√		R-PK-CL05
			√	R-PK-CL05B
SUJETADOR PORTAMEMB./POSFIL	√	√		R-PK-CL04
			√	R-PK-CL04B
SUJETADOR POSTFIL./LAMP.UV		√	√	R-PK-CL07
TANQUE	√	√		R-PK-T-3.2G
VÁLVULA DE ALIMENTACIÓN	√	√		R-PK-VA-05
			√	R-PK-VA06
SWITCH DE ALTA PRESIÓN	√	√		R-PK-DCC023
SWITCH DE ALTA PRESIÓN			√	R-PK-YK1-N
SWITCH DE BAJA PRESIÓN	√	√	√	R-PK-DCC-022
VÁLVULA SOLENOIDE	√	√		R-PK-SVA8272Q
VÁLVULA SOLENOIDE			√	R-PK-8272
CONTROLADOR LCD		√		R-PK-CB-5
VÁLVULA ESFERA (1/4", 1/4")	√	√		R-PK-DCC-024
SOPORTE	√	√		R-PK-BRARO-6
			√	R-PK-BRARO-400
ADAPTADOR CODO "L" (RM1/4", T3/8")			√	R-PK-DCC-002C
ADAPTADOR CODO "L" (RM3/8", T3/8")			√	R-PK-DCC-002D
ADAPTADOR CODO "L" (RM3/8", T1/4")	√	√		R-PK-DCC-005A
ADAPTADOR "T" (T1/4", RM1/4", T1/4")	√			R-PK-DCC-007A
ADAPTADOR "T" (T3/8", RM1/4", T3/8")			√	R-PK-DCC-007G
ADAPTADOR "T" (RM1/4", T1/4", T1/4")	√	√	√	R-PK-DCC-008A
ADAPTADOR "T" (T1/4", T1/4", T1/4")		√	√	R-PK-DCC-009A
ADAPTADOR RECTO (RM1/4", T1/4")			√	R-PK-DCC-012A
ADAPTADOR RECTO (RM1/4", T3/8)			√	R-PK-DCC-012D
CODO VÁLVULA CHECK RM1/4"-T1/4"	√	√	√	R-PK-DCC-020A
RESTRICTOR DE FLUJO	√	√		R-PKTF-450M
			√	R-PKTF-1200M
VALVULA SOLENOIDE AUTOFLUSH			√	R-PK-SVA8261
	√			R-PK-SVA8261Q

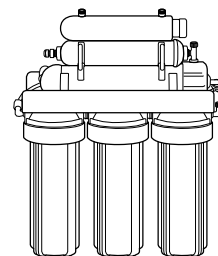
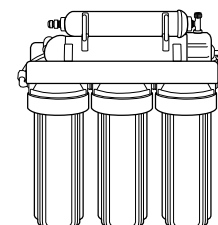



REFACCIÓN	PK-VITA-CFT-1054	PK-VITA-CFT-946	PK-VITA-CSD-1054	PK-VITA-CSD-1035	PK-VITA-CSD-946	PK-VITA-CSD-1248	PK-VITA-CST-1054	PK-VITA-CST-1035	PK-VITA-CST-946	PK-VITA-CST-1248	PK-VITA-EFT-1054	PK-VITA-EFT-946	PK-VITA-ESD-1054	PK-VITA-ESD-1035	PK-VITA-ESD-946	PK-VITA-ESD-1248	PK-VITA-GFT-1054	PK-VITA-GFT-946	PK-VITA-GFT-1248	PK-VITA-GSD-1054U	PK-VITA-GSD-948U	PK-VITA-GSD-1354U	PK-VITA-GSD-1248U	PK-VITA-GSD-1466U	CÓDIGO
PISTON	✓	✓																							R-PKVITACFT-PIST-F
			✓	✓	✓	✓	✓	✓	✓	✓								✓	✓	✓	✓	✓	✓	✓	R-PKVITACE-PISTON
SELLOS ESPACIADORES	✓	✓	✓	✓	✓	✓	✓	✓	✓	✓		✓	✓	✓	✓	✓									R-PKVITAG-PISTON
																		✓	✓	✓	✓	✓	✓	✓	R-PKVITACE-KIT-SE
CONJ. VALVULA P/MEZCLAR			✓	✓	✓	✓	✓	✓	✓	✓			✓	✓	✓	✓									R-PKVITAG-KIT-SE
CONJ. VALVULA SALMUERA			✓	✓	✓	✓	✓	✓	✓	✓			✓	✓	✓	✓									R-PKVITACE-VALVULA
TARJETA DE CONTROL																		✓	✓	✓	✓	✓	✓	✓	R-PKVITACEG-VAL-SA
																									R-PKVITAG-T-CTRL
BYPASS											✓	✓	✓	✓	✓	✓									R-PKVITAE-T-CTRL
																					✓	✓	✓	✓	R-PKVITAGSD-VALV-B
MONITOR											✓	✓	✓	✓	✓	✓									R-PKVITAE-VALV-B
																		✓	✓	✓	✓	✓	✓	✓	R-PKVITAG-MON-REM
CABLE COMUNICACIÓN																		✓	✓	✓	✓	✓	✓	✓	R-PKVITAG-MON-INA
CABLE MEDIDOR			✓	✓	✓	✓												✓	✓	✓	✓	✓	✓	✓	R-PKVITAG-CBL-COM
TRANSFORMADOR																		✓	✓	✓	✓	✓	✓	✓	R-PKCUOREVITA-TRAN
																									R-PKVITAE-TRANSFOR
CONJUNTO DE MEDIDOR			✓	✓	✓	✓																			R-PKVITACSD-MEDIDO
																									R-PKVITAESD-MEDIDO
ADAPTADOR	✓	✓	✓	✓	✓	✓	✓	✓	✓	✓	✓	✓	✓	✓	✓	✓									R-PKVITACE-ADAP-C
CONECTOR	✓	✓	✓	✓	✓	✓	✓	✓	✓	✓	✓	✓	✓	✓	✓	✓									R-PKVITACE-CONECT
MEDIDOR																					✓	✓	✓	✓	R-PKVITAGSD-EN-MED
INTERRUPTOR											✓	✓	✓	✓	✓	✓									R-PKVITAE-INTERRUP
MOTOR											✓	✓	✓	✓	✓	✓									R-PKVITAE-MOTOR

REFACCIÓN	PK-CUORE-FFT-2162	PK-CUORE-FFT-1865	PK-CUORE-FFT-1865	PK-CUORE-FFT-2162U	PK-CUORE-FFT-1865	PK-CUORE-FFT-1865	PK-CUORE-FFT-1865	PK-CUORE-FFT-1865	PK-CUORE-FFT-2472	PK-CUORE-FFT-2162	PK-CUORE-FFT-2472	PK-CUORE-FFT-3072	PK-CUORE-FFT-2162	PK-CUORE-FFT-2472	PK-CUORE-FFT-3072	PK-CUORE-FFT-2162	PK-CUORE-FFT-3072	PK-CUORE-FFT-2162	PK-CUORE-FFT-3072	PK-CUORE-FFT-2162	PK-CUORE-FFT-3072	PK-CUORE-FFT-2162	PK-CUORE-FFT-3072	PK-CUORE-FFT-2162	PK-CUORE-FFT-3072	PK-CUORE-FFT-2162	PK-CUORE-FFT-3072	PK-CUORE-FFT-2162	PK-CUORE-FFT-3072	CÓDIGO	
BASE	✓	✓	✓	✓	✓	✓	✓	✓																							R-PKCUOREP-BASE-V
																															R-PKCUORET-BASE-V
BASTAGO					✓	✓	✓	✓	✓	✓	✓	✓	✓	✓	✓	✓	✓	✓	✓	✓	✓	✓	✓	✓	✓	✓	✓	✓	✓	✓	R-PKCUOREPT-TORVAS
CODO	✓	✓	✓	✓	✓	✓	✓	✓	✓	✓	✓	✓	✓	✓	✓	✓	✓	✓	✓	✓	✓	✓	✓	✓	✓	✓	✓	✓	✓	✓	R-PKCUOREPT-CODO
CONJ. VALVULA SALMUERA																														R-PKCUOREUSD-VAL-S	
CUERPO DE VALVULA					✓	✓	✓	✓	✓	✓	✓	✓	✓	✓	✓	✓	✓	✓	✓	✓	✓	✓	✓	✓	✓	✓	✓	✓	✓	R-PKCUOREPT-C-VALV	
EJE																														R-PKCUOREUSD-EJE	
ENGRANAJE	✓	✓	✓	✓	✓	✓	✓	✓	✓	✓	✓	✓	✓	✓	✓	✓	✓	✓	✓	✓	✓	✓	✓	✓	✓	✓	✓	✓	✓	R-PKCUOREPT-ENGRAN	
EPAQUE	✓	✓	✓	✓	✓	✓	✓	✓	✓	✓	✓	✓	✓	✓	✓	✓	✓	✓	✓	✓	✓	✓	✓	✓	✓	✓	✓	✓	✓	R-PKCUOREPT-EMPAQ	
IMPULSOR																														R-PKCUOREUSD-ENS-I	
INSERTO	✓	✓	✓	✓	✓	✓	✓	✓	✓	✓	✓	✓	✓	✓	✓	✓	✓	✓	✓	✓	✓	✓	✓	✓	✓	✓	✓	✓	✓	R-PKCUOREPT-INSERT	
INYECTOR																														R-PKCUOREUSD-INYEC	
KIT RACOR	✓	✓	✓	✓	✓	✓	✓	✓																						R-PKCUOREP-RAC1.25	
																														R-PKCUORET-RAC1.5	
	✓	✓	✓	✓	✓	✓	✓	✓																						R-PKCUOREP-RACLISO	
MEDIDOR																														R-PKCUOREPT-MEDIDO	
MOTOR	✓	✓	✓	✓	✓	✓	✓	✓	✓	✓	✓	✓	✓	✓	✓	✓	✓	✓	✓	✓	✓	✓	✓	✓	✓	✓	✓	✓	✓	R-PKCUOREPT-MOTOR	
																														R-PKCUOREU-MOTOR	
O RING																														R-PKCUOREUSD-ORING	
PIÑÓN																														R-PKCUOREU-PIÑON-A	
PISTON	✓	✓	✓	✓	✓	✓	✓	✓	✓	✓	✓	✓	✓	✓	✓	✓	✓	✓	✓	✓	✓	✓	✓	✓	✓	✓	✓	✓	✓	R-PKCUOREPT-PISTON	
SELLOS ESPACIADORES	✓	✓	✓	✓	✓	✓	✓	✓	✓	✓	✓	✓	✓	✓	✓	✓	✓	✓	✓	✓	✓	✓	✓	✓	✓	✓	✓	✓	✓	R-PKCUOREPT-KIT-SE	
																														R-PKCUOREU-KIT-SE	
SOPORTE	✓	✓	✓	✓	✓	✓	✓	✓	✓	✓	✓	✓	✓	✓	✓	✓	✓	✓	✓	✓	✓	✓	✓	✓	✓	✓	✓	✓	✓	R-PKCUOREPT-SOPORT	
TAPA DE MEDIDOR																														R-PKCUOREUSD-TAPME	
TARJETA DE CONTROL	✓	✓	✓	✓	✓	✓	✓	✓	✓	✓	✓	✓	✓	✓	✓	✓	✓	✓	✓	✓	✓	✓	✓	✓	✓	✓	✓	✓	✓	R-PKCUOREPT-T-CTRL	
TEMPORIZADOR																														R-PKCUOREUFT-TEMP	
TRANSFORMADOR	✓	✓	✓	✓	✓	✓	✓	✓	✓	✓	✓	✓	✓	✓	✓	✓	✓	✓	✓	✓	✓	✓	✓	✓	✓	✓	✓	✓	✓	R-PKCUOREVITA-TRAN	
																														R-PKCUOREU-TRANSF	
TUBO																														R-PKCUOREUFT-INYEC	
	✓	✓	✓	✓	✓	✓	✓	✓	✓	✓	✓	✓	✓	✓	✓	✓	✓	✓	✓	✓	✓	✓	✓	✓	✓	✓	✓	✓	✓	R-PKCUOREPT-TUBO-L	



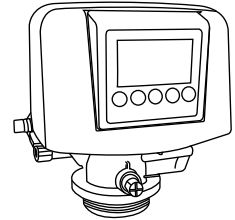

REFACCIÓN	PKVF26T	PKVF26D	PKVF27D	PKVF32D	PKVF48D	PKVS26T	PKVS26D	PKVS27D	PKVS32D	PKVS48D	CÓDIGO
COLECTOR SUPERIOR 2.5"	✓	✓	✓	✓		✓	✓	✓	✓		R-PK07060009P
CONEX. RÁPIDA 3/8" SALM	✓	✓				✓	✓	✓			R-PK21499233M
TRANSFORMADOR	✓	✓	✓	✓	✓	✓	✓	✓	✓	✓	R-PK11040038
CONECTOR 1" BYPASS	✓	✓	✓			✓	✓	✓			R-PK21319011N
CONECTOR 3/4" BYPASS	✓	✓	✓			✓	✓	✓			R-PK21319016N
ANILLO DE SELLADO	✓	✓	✓			✓	✓	✓			R-PK-AS6073
				✓					✓		R-PK-AS3006
					✓					✓	R-PK-AS0133
BASE PRINCIPAL PKVSF48					✓					✓	R-PKVSF48DBASE
CONEX. RÁPIDA P/SALMUERA					✓					✓	R-PK05040013M
CLIP (L)					✓					✓	R-PK05040017M
CLIP (S)					✓					✓	R-PK05040018M
CONEX. RÁPIDA P/DRENADO					✓					✓	R-PK05040012M
LLAVE BYPASS	✓	✓	✓	✓		✓	✓	✓	✓		R-PK70020007M
CONECTOR ENTRADA SALIDA	✓	✓	✓			✓	✓	✓			R-PK-02170056P
CONECTOR 3/4" BYPASS "L"	✓	✓	✓			✓	✓	✓			R-PK21319036N
KIT CLIP PARA BYPASS	✓	✓	✓			✓	✓	✓			R-PK60090502
CLIP CANDADO BYPASS	✓	✓	✓			✓	✓	✓			R-PK21709003N
MOTOR PARA VÁLVULA	✓	✓				✓	✓				R-PK-05011026
					✓					✓	R-PK-05056510
O-RING	✓	✓	✓	✓		✓	✓	✓	✓		R-PK-06010103
					✓					✓	R-PK-26010030
KIT DE REFACCIONES	✓					✓					R-PK-05005601M
	✓					✓					R-PK-05005602M
CLIP CAND. CONE. DRE/ SALM BYPASS CONEX. 3/4"	✓	✓	✓			✓	✓	✓			R-PK05056172N
	✓	✓	✓			✓	✓	✓			R-PK02170015Q
SILENCIADOR SELLOS Y ESPACIADOR	✓	✓				✓	✓				R-PK-02170029
			✓					✓			R-PK-02170102
				✓					✓		R-PK-05005639M
					✓					✓	R-PK-02170122
	✓	✓				✓	✓				R-PK-05056104M
SENSOR DE TARJETA					✓					✓	R-PK-05040052
KIT DE PISTÓN	✓	✓				✓	✓				R-PK-02170028
					✓					✓	R-PK-02170127
			✓								R-PK-02170100
				✓							R-PK-02170163
								✓			R-PK-02170101
									✓		R-PK-02170164
TARJETA DE CONTROL				✓					✓		R-PK-05033008B
		✓					✓				R-PK05056549
			✓					✓			R-PK-05031023
TARJETA PRINCIPAL			✓								R-PK-05031026
								✓			R-PK-05031025
										✓	R-PK-05040051B
ENGRANE PARA PKVF48D					✓					✓	R-PK60095002
ENGRANE PARA PKVF32D				✓					✓		R-PK92389
A05 Camara de conducción para PKVSF48D					✓					✓	R-PK02170186
MOTOR PARA VALVULA	✓					✓					R-PK05056110
		✓					✓				R-PK-05056510
			✓	✓				✓	✓		R-PK-05056550
					✓					✓	R-PK-05011026
CLIP ADAPTADOR PARA BYPASS PKV	✓	✓	✓			✓	✓	✓			R-PK60010046
TORNILLO PARA BYPASS PKV	✓	✓	✓			✓	✓	✓			R-PK60010047
KIT ESPACIADOR PARA PKVS26T	✓	✓				✓	✓				R-PK60125
CUERPO DE VÁLVULA P/PKVF26D	✓	✓				✓	✓				R-PK60095609
ENGRANAJE SUPERIOR PARA VALV.48D #A22					✓					✓	R-PK-05040040
KIT SELLOS ESPECIADORES P/VALV.48D #B05					✓					✓	R-PK20500285
O-RING P/CONNECT.ENT/SAL.VALV 22.4X3.55	✓	✓	✓			✓	✓	✓			R-PK26010143
PISTON P/ VALVULA F 32D				✓							R-PK02170165
SEGURO DEL ADAPTADOR DEL BYPASS	✓	✓	✓			✓	✓	✓			R-PK05056044B

REFACCIONES TANQUES DE FIBRA Y SALMUERA

REFACCIÓN	PKT0948/1035/1054	PKT1865-5	PKT2162-7	PKT2472-10	PKT3072-15	PKT3672-20	PKSOFT1035	PKSOFT1044	PKTS100	PKTS145	PKTS200	CÓDIGO
	/1248/1354/1465/1665											
COLECTOR INFERIOR	✓	✓										R-PK02170012P
			✓									R-PK07060025
				✓								R-PK07060022
					✓							R-PKW00001342
						✓						R-PKW00001343
TUBO CENTRAL		✓	✓									R-PK07160037
ADAPTADOR		✓	✓	✓								R-PK02170079
TAPA TRANSPDE CUBIERTA							✓					R-PK07030284M
INSERTO PARA TUBO CONEX.									✓	✓	✓	R-PK30110004M
CUBIERTA							✓					R-PK02170106B

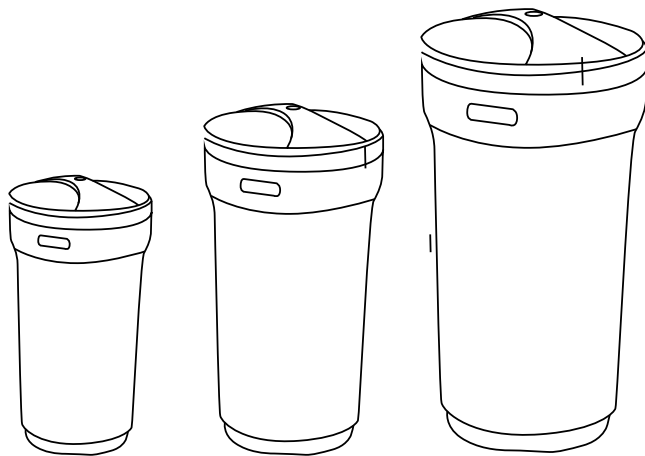

**REFACCIONES
PORTAFILTROS**

REFACCIÓN	PKPF	PKPFBB	CÓDIGO
SOPORTE	√		R-PK-BRA122
SOPORTE BIG BLUE		√	R-PK-BRA124
LLAVE PORTAFILTRO		√	R-PK-WR-01
O-RING PORTAFILTRO		√	R-PKORINGPFB
O-RING PORTAFILTRO BIG BLUE		√	R-PK-ORINGPFB
PORTAFILTRO BIG BLUE 10X1 PURGA		√	PKPFBB10X1P
PORTAFILTRO BIG BLUE 20X1.5 PURGA		√	PKPFBB20X1.5P
BOTÓN PURGA PFB		√	R-PK-BOTONP4.5

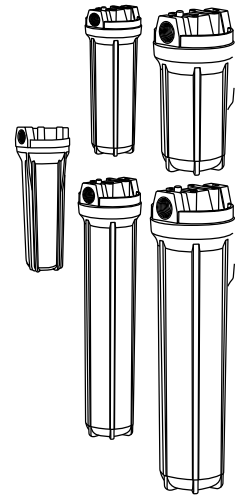
REFACCIONES PORTAMEMBRANAS

REFACCIÓN	PK-PM 40E300	PK-PM 40S300	PK-PM 80S300	CÓDIGO
PLACA DE SELLO	√		√	R-PK601
		√		R-PK646
			√	R-PK651
CONO DE EMPUJE			√	R-PK614
ADAPTADOR			√	R-PK615
O-RING PARA ADAPTADOR			√	R-PK917
PLACA DE APOYO			√	R-PK339
TIRANTE			√	R-PK302-1
	√			R-PK302-2
		√		R-PK302-3
SOPORTE			√	R-PK936
	√			R-PK935-2
		√		R-PK935-3
TORNILLERÍA			√	R-PK304
	√	√		R-PK303
ANILLO DE RET. PUERTO LATERAL			√	R-PK337
O-RING X			√	R-PK910
O-RING BIG			√	R-PK904
	√	√		R-PK901
O-RING P/ PUERTO DE PERMEADO			√	R-PK916
ETIQUETA PARA PORTAMEMBRANA			√	R-PK1547
	√	√		R-PK1548
ETIQUETA TAPA POSTERIOR			√	R-PK1546
O-RING PARA PUERTO LATERAL			√	R-PK911
ANILLO DE RET. PUERTO FINAL LAT.			√	R-PK391
TAPA PUERTO CONCENTRADO 3/4"	√			R-PK612
TAPA PUERTO PERMEADO 1/2"	√	√		R-PK611
TAPA PUERTO PERMEADO 1"			√	R-PK618
DEFLECTORES	√	√		R-PK301
O-RING SM. CON SELLO DE GOMA	√			R-PK908
		√		R-PK908-1
O-RING PUERTOS LATERALES		√		R-PK903
JUNTA PUERTOS LATERALES		√		R-PK439

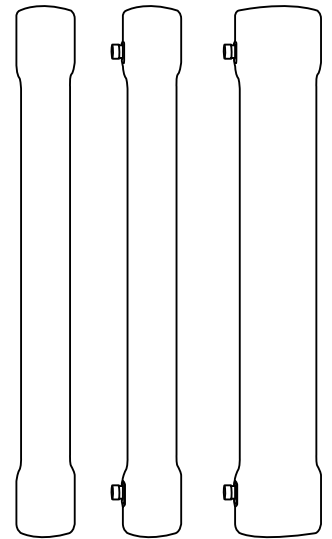



REFACCIONES

VARIADORES W-DRIVE



REFACCIÓN	W-DRIVE2M2M/08	W-DRIVE2M2T/10	CÓDIGO
TAPA MAYOR	√	√	R-WDRIVE08/10 TMA
TAPA MENOR	√	√	R-WDRIVE08/10 TME
TARJETA DE CONTROL + DISPLAY	√	√	R-WDRIVE2M2M8 TCD
BASE	√	√	R-WDRIVE2M2T10 TCD
KIT DE SENSOR DE PRESIÓN	√	√	R-WDRIVE08/10 BASE
			R-WDRIVE08/10 KSP

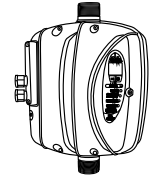

VARIADORES F-DRIVE

REFACCIÓN	FDRIVE2397-M/MT	FDRIVE2391-M/MT	FDRIVE4609-TT	FDRIVE2318-TT	FDRIVE2325-TT	FDRIVE2330-TT	FDRIVE4614-TT	FDRIVE4618-TT	FDRIVE4625-TT	FDRIVE4630-TT	FDRIVE2318-MT	FDRIVE2325-MT	CÓDIGO
DIPLAY	√	√	√	√	√	√	√	√	√	√	√	√	R-FD DISPLAY
TAPA	√	√											R-FD7911 TAPA
			√	√	√	√	√	√	√	√			R-FD TT TAPA
*TARJETA DE CONTROL	√	√	√	√	√	√	√	√	√	√	√	√	R-FD TCTRL
FILTRO EMC											√	√	R-FD-FILTROEMC



*Al solicitar esta pieza es necesario compartir el número de serie del equipo

VARIADORES L-DRIVE

REFACCIÓN	L-DRIVEMT 230V-4A	L-DRIVEMT 230V-7A	L-DRIVEMT 230V-10A	CÓDIGO
BASE	√	√	√	R-L-DRIVE BASE
TAPA	√	√	√	R-L-DRIVE TAPA

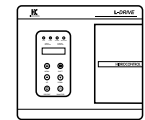
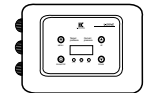

VARIADORES R-DRIVE PLUS

REFACCIÓN	RDRIVEPMTPL 10/230	RDRIVEPMTPL 10/230	RDRIVEPATTPL 15/230	RDRIVEPATTPL 18/230	RDRIVEPATTPL 25/230	CÓDIGO
TARJETA DE CONTROL	√	√	√	√	√	R-RDRIVEPL10-25TC
TRANSDUCTOR DE PRESIÓN	√	√	√	√	√	R-RDRIVEPL10-25TRS
TARJETA AVANZADA	√	√				R-RDRIVEPL10TA





REFACCIONES VARIADORES R-DRIVE



REFACCIÓN	R-DRIVEPMM 12/230	R-DRIVEPMT 10/230	R-DRIVEPAT 15/230	CÓDIGO
TARJETA DE CONTROL	√			R-RDRIVEWMM TC
		√		R-RDRIVEAMT TC
			√	R-RDRIVEATT TC
DISPLAY	√	√		R-RDRI.WAMM/MT DI
			√	R-RDRIVEATT DI+TL
TAPA	√			R-RDRIVEWMM TAPA
		√		R-RDRIVAMT10 TAPA
			√	R-RDRIVEATT TAPA
TARJETA DE FLUJO	√			R-RDRIVEWMM TF
BASE	√			R-RD.WMM BASE
		√		R-RD.AMT BASE
			√	R-RDRIVEATT BASE
TARJETA AVANZADA			√	R-RDRIVEATT T.AVA
VENTILADOR		√		R-RDRIVEAMT VENT
			√	R-RDRIVEATT VENT
SOPORTE PARA VALVULA CHECK	√			R-RDRI.WMM SPTE VC
VALVULA CHECK	√			R-RDRI.WMM V.CHECK
CONVERTIDOR V HZ			√	R-RDRIVEATT CONV.

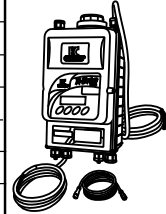

VARIADORES B-DRIVE

REFACCIÓN	B-DRIVEATT25/440	B-DRIVEATT32/440	CÓDIGO
FILTRO	√	√	R-BDATT4-FILTRO
FUENTE	√	√	R-BDATT4-FUENTE
TARJETA DE CONTROL	√	√	R-BDATT4-TC
TARJETA DE POTENCIA	√		R-BDATT4-25-TP
		√	R-BDATT4-32-TP

VARIADORES B-DRIVE

REFACCIÓN	B-DRIVEAMM 12/230	B-DRIVEAMT 10/230	B-DRIVEWMM 12/230	B-DRIVEWMT 10/230	BDRIVEWM 11A127/230	BDRIVEWM 14A127/230	CÓDIGO
CABLE PLANO FLEX			√	√	√	√	R-BD-W-FLEX
TARJETA DEL TRANSDUCTOR			√	√	√	√	R-BD-CIR.TRANSDUC
KIT CUERPO, DISIPADOR Y TRANSDUCTOR			√	√	√	√	R-BD-KIT.CUERPO
RACOR			√	√	√	√	R-BD-RACOR
TAPA PLÁSTICA	√	√					R-BD-TAPA
TARJETA DE CONTROL	√	√					R-BD-TCONTROL
TARJETA DE CONTROL			√	√	√	√	R-BD-W-TCONTROL
TARJETA DE SENSOR			√	√	√	√	R-BD-TSENSOR
TRANSDUCTOR DE PRESIÓN	√	√					R-BD-TRPS
VENTILADOR	√	√					R-BD-VENTILADOR

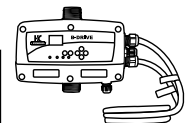

Enfriado por agua

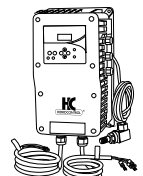

Enfriado por aire



REFACCIONES
BOMBAS DE CALOR

REFACCIÓN	EKN 65/1230-C	EKN 90/1230-C	EKN 110/1230-C	EKN 110/3230-C	EKN 120/1230-C	EKN 120/3230-C	EKN 136/1230-C	CÓDIGO
TARJETA DE CONTROL	√	√	√	√	√	√	√	012-009-D-002
SENSOR DE TEMP. (AGUA)	√	√	√	√	√	√	√	012-009-D-003
CONTACTOR, 2 POLOS, 40A	√	√	√	√	√	√	√	012-009-D-004
CAP., 7.5UF, 370V P/VENT.	√	√	√	√	√	√	√	012-009-D-005
CAP., 80UF, 370V P/COMP.	√	√	√		√		√	012-009-D-007
TRANSFORMADOR 230/24V	√	√	√	√	√	√	√	012-009-D-011
UNIÓN 2" EKOAL	√	√	√	√	√	√	√	012-009-D-013
SWITCH ALTA PRES. EKN R410	√	√	√	√	√	√	√	012-009-D-018
SWITCH BAJA PRES. EKN R410	√	√	√	√	√	√	√	012-009-D-019
VÁLV. DE EXP. TÉR. EKN R410	√	√	√	√	√	√	√	012-009-D-020
ASPAS P/VENTILADOR KIT	√	√	√	√	√	√	√	012-009-D-024
SENS. FLUJO BOMBA EKOAL EKN	√	√	√	√	√	√	√	EKN1001012
REJILLA DE VENT. DE EKN	√	√	√	√	√	√	√	R-EKN-REJVENT

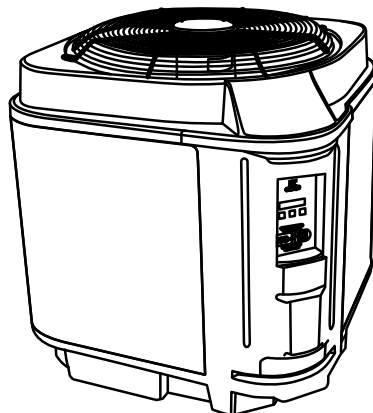

EKFC80/1230SPA

REFACCIÓN	CÓDIGO
KIT DE PANEL	R-EKFC80-KITPAN
VENTILADOR	R-EKFC80-VENT
MOTOR PARA VENTILADOR	R-EKFC80-MOTVENT
COMPRESOR	R-EKFC80-COMP
INTERCAMBIADOR DE TITANIO	R-EKFC80-TITAN
SWITCH DE FLUJO	R-EKFC80-SWF
VÁLVULA DE 4 VÍAS	R-EKFC80-VAL4V
VÁLVULA DE EXPANSIÓN	R-EKFC80-VET
CONTROLADOR FRÍO-CALOR	R-EKFC80-CONTFC
KIT RACOR	R-EKFC80-KRAC
VÁLVULA DE ALTA Y BAJA PRESIÓN	R-EKFC80-VABP
SENSOR DE TEMPERATURA	R-EKFC80-STEMP
CAJA CONTROL MONT. EXTERNO	R-EKFC80-CCME
TARJETA ELECTRÓNICA	R-EKFC80-TELECT
TRANSFORMADOR	R-EKFC80-TRANSF
CONTACTOR	R-EKFC80-CONT
CAPACITOR DEL COMPRESOR	R-EKFC80-CCOM
CAP. MOTOR DEL VENTILADOR	R-EKFC80-CVENT

EKFC50/1230SPA

REFACCIÓN	CÓDIGO
CABLE DE SEÑAL	R-EKFC50-C10M
CAJA CONTROL PARA MONT. EXT.	R-EKFC50-CCME
CAPACITOR DEL COMPRESOR	R-EKFC50-CCOM
CONJUNTO DE DRENADO	R-EKFC50-CD
COMPRESOR	R-EKFC50-COMP
CONTACTOR	R-EKFC50-CONT
CONTROLADOR FRÍO-CALOR	R-EKFC50-CONTFC
CAP. PARA MOTOR DEL VENTILADOR	R-EKFC50-CVENT
INTERCAMBIADOR DE TITANIO	R-EKFC50-TITAN
KIT DE PANEL	R-EKFC50-KITPAN
KIT RACOR	R-EKFC50-KRAC
MOTOR PARA VENTILADOR	R-EKFC50-MOTVENT
SENSOR DE TEMPERATURA	R-EKFC50-STEMP
SWITCH DE FLUJO	R-EKFC50-SWF
TARJETA ELECTRÓNICA	R-EKFC50-TELECT
TRANSFORMADOR	R-EKFC50-TRANSF
VÁLVULA DE ALTA Y BAJA PRESIÓN	R-EKFC50-VABP
VÁLVULA DE 4 VÍAS	R-EKFC50-VAL4V
VENTILADOR	R-EKFC50-VENT
VÁLVULA DE EXPANSIÓN	R-EKFC50-VET
TAPA SUPERIOR	R-EKFC50-TAP-SUP

EKFC110/1230SPA

REFACCIÓN	CÓDIGO
CAPACITOR DEL COMPRESOR 100 mF	R-EKFC110-C100COM
CAJA DE CONTROL MONT. EXTERNO	R-EKFC110-CCME
CAPACITOR DEL COMPRESOR	R-EKFC110-CCOM
COMPRESOR	R-EKFC110-COMP
CONTACTOR	R-EKFC110-CONT
CONTROLADOR FRÍO-CALOR	R-EKFC110-CONTFC
CAPACITOR PARA MOTOR VENTILADOR	R-EKFC110-CVENT
INTERCAMBIADOR DE TITANIO	R-EKFC110-TITAN
KIT DE PANEL	R-EKFC110-KITPAN
KIT RACOR	R-EKFC110-KRAC
MOTOR PARA VENTILADOR	R-EKFC110-MOTVENT
RELEVADOR DE ARRANQUE	R-EKFC110-RELARR
SENSOR DE TEMPERATURA	R-EKFC110-STEMP
SWITCH DE FLUJO	R-EKFC110-SWF
TARJETA ELECTRÓNICA	R-EKFC110-TELECT
TRANSFORMADOR	R-EKFC110-TRANSF
VÁLVULA DE ALTA Y BAJA PRESIÓN	R-EKFC110-VABP
VÁLVULA DE 4 VÍAS	R-EKFC110-VAL4V
VENTILADOR	R-EKFC110-VENT
VÁLVULA DE EXPANSIÓN	R-EKFC110-VET

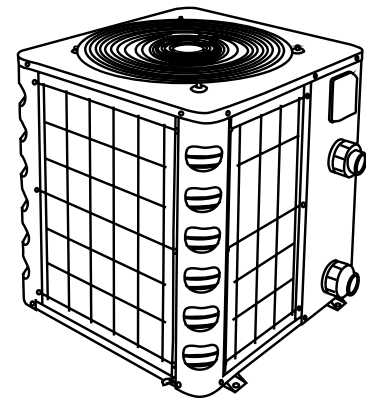



REFACCIONES

BOMBAS DE CALOR EKC INVERTER



REFACCIÓN	EKCINV 40/1230	EKCINV 50/1230	EKCINV 65/1230	EKCINV 90/1230	EKCINV 110/1230	EKCFINV 140/1230	CÓDIGO
BOBINA PARA EKCFINV 140						√	R-EKCF140-BOBINA
COMPRESOR						√	R-EKCF140-COMPRES
DISPLAY WIFI	√	√	√	√	√	√	R-EKCINV-DISP-WIFI
FILT. DESHUMIDIFICADOR P/BOMBAS INVERTER	√	√	√	√	√	√	R-EKCINV-FILDESHUM
FILTRO DE POTENCIA						√	R-EKCF140-FIL.POT
INTERCAMBIADOR DE CALOR						√	R-EKCF140-INTERCAM
KIT DRENAJE	√	√	√	√			R-EKCINV-DRENAJE
MÓDULO DE MOTOR DE VENTILADOR					√	√	R-EKCF140-MOD.MV
MOTOR DE VENTILADOR					√	√	R-EKCF140-MOT.V
RACOR					√	√	R-EKCF140-RACOR
SENSOR DE FLUJO	√	√	√	√	√	√	R-EKCINV-SW-FLUJO
SET DE SENSORES	√	√	√	√	√	√	R-EKCINV-SENSORES
SWITCH DE ALTA PRESIÓN					√	√	R-EKCF140-SW.ALTA
SWITCH DE BAJA PRESIÓN					√	√	R-EKCF140-SW.BAJA
TARJETA INVERTER						√	R-EKCF140-T.INV
TARJETA PC FRIO CALOR						√	R-EKCF140-TPC-CF
VÁLVULA DE 4 VÍAS						√	R-EKCF140-VALV.4V
VÁLVULA DE ALTA/BAJA PRESIÓN				√	√	√	R-EKCINV-VAL-PRES
VÁLVULA DE EXPANSIÓN						√	R-EKCF140-VAL.EXP
VENTILADOR						√	R-EKCF140-ASPAS

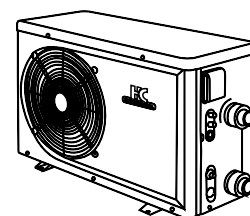

REFACCIONES BOMBAS DE CALOR EKRC32-110

REFACCIÓN	EKRC- 24SPA/1230	EKRC- 32SPA/1230	EKRC- 53SPA/1230	EKRC- 110SPA/1230	CÓDIGO
ASPAS DE VENTILADOR		√	√	√	R-EKRC-ASPAS
CAPACITOR DE COMPRESOR		√	√	√	R-EKRC-CAP-COMP-A
CAPACITOR/MOTOR VENTILADOR		√	√	√	R-EKRC-CAP-COMP-B
COMPRESOR		√	√	√	R-EKRC-CAP-VENT-A
			√	√	R-EKRC-CAP-VENT-B
		√	√	√	R-EKRC-COMPRESOR-A
	√		√	√	R-EKRC-COMPRESOR-B
			√	√	R-EKRC-COMPRESOR-C
CONTACTOR		√	√	√	R-EKRC-CONTACTOR
CUBIERTA DE VENTILADOR		√	√	√	R-EKRC-CUBIER-REJ
PANTALLA	√				R-EKRC-CUBIER-VENT
TERMINALES	√				R-EKRC24-DISPLAY
		√			R-EKRC-TERM-A
			√	√	R-EKRC-TERM-B
TARJETA DE CONTROL		√	√	√	R-EKRC-TCONTROL

REFACCIONES BOMBAS DE CALOR EKRC13

REFACCIÓN	EKRC-13SPA-1127	EKRC-13SPA-1230	CÓDIGO
CAPACITOR COMPRESOR 50UF	√		R-EKRC13-C-COMP127
CAPACITOR COMPRESOR 25UF		√	R-EKRC13-C-COMP230
CAPACITOR DE MOTOR 3UF	√		R-EKRC13-C-MOT127
CAPACITOR DE MOTOR 1.5UF		√	R-EKRC13-C-MOT230
DISPLAY	√		R-EKRC13-DISPLAY-1
		√	R-EKRC13-DISPLAY-2
RACOR	√	√	R-EKRC13-RACOR
SENSOR DE FLUJO	√	√	R-EKRC13-SEN-FLUJO
SWITCH DE ALTA Y BAJA PRESION	√	√	R-EKRC13-SWITCH-AB
VENTILADOR	√	√	R-EKRC13-VENT





REFACCIONES

PRESURIZADOR INTELIGENTE (127V)
SERIE I-DRO

REFACCIÓN	I-DROX-18-2-127	CÓDIGO
KIT DE REPARACIÓN MENOR	✓	R-IDROX-KIT-REPMAN
KIT DE CUERPO HIDRAULICO	✓	R-IDROX-KIT- HIDRA
CUERPO DE BOMBA	✓	R-IDROX-CUERPBOMB
DESCARGA	✓	R-IDROX-DESCARGA
PLATO PORTA SM	✓	R-IDROX-PLASELLO
SENSOR DE PRESIÓN	✓	R-IDROX-SENSORPRES
TANQUE PRECARGADO	✓	R-IDROX-TANQUE
TAPÓN DE PURGA	✓	R-IDROX-TAPPURGA
KIT DE CUBIERTA I-DROX	✓	R-IDROX-KITCUBIERT
PIE DE BOMBA	✓	R-IDROX-PIEBOMBA
RESORTE DISTANCIADOR	✓	R-IDROX-RESORTDIS
KIT CONTROLADOR	✓	R-IDROX-KIT- CTRL
TARJETA PCBA DISPLAY	✓	R-IDROX-PCBADISP
VÁLVULA CHECK	✓	R-IDROX-VALVCHECK
VENTILADOR	✓	R-IDROX-VENT
CUBIERTA	✓	R-IDROX-CUBIERTBOM
KIT TAPAS MOTOR	✓	R-IDROX-TAPMOTOR
TONILLO M5x 155	✓	R-IDROX-TORNM5



REFACCIONES

PRESURIZADOR INTELIGENTE (127V)
SERIE I-DRO

REFACCIÓN	I-DRO-26-1-127	CÓDIGO
KIT DE REPARACIÓN MENOR	✓	R-IDRO-KIT-REPMAN
KIT DE CUERPO HIDRAULICO	✓	R-IDRO-KIT- HIDRA
PLATO PORTA SM I-DRO	✓	R-IDRO-PLASELLO
SENSOR DE PRESIÓN	✓	R-IDRO-SENSORPRES
SUCCIÓN DE BRIDA	✓	R-IDRO-SUCCION
TANQUE PRESURIZADO	✓	R-IDRO-TANQUE
TAPÓN DE PURGA	✓	R-IDRO-TAPPURGA
VÁLVULA CHECK	✓	R-IDRO-VALCHECK
VENTILADOR	✓	R-IDRO-VENT
CONTROLADOR	✓	R-IDRO-CTRL
PIE DE BOMBA I-DRO	✓	R-IDRO-PIEBOMBA
KIT DE CUBIERTA I-DRO	✓	R-IDRO-KITCUBIERT
CUERPO DE BOMBA	✓	R-IDRO-CUERPBOMB
KIT TAPAS MOTOR	✓	R-IDRO-KIT-TMOTOR

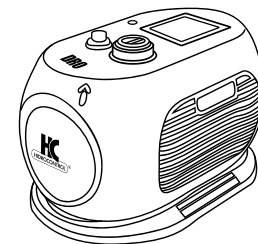



REFACCIONES
PRESURIZADOR INTELIGENTE (127V)
SERIE I-DRO

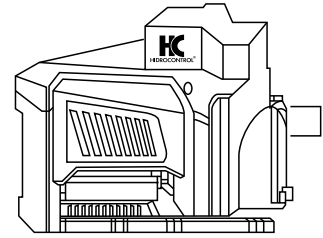

REFACCIÓN	I-DRO-70-127	I-DRO-83-127	I-DRO-94-230	CÓDIGO
CUERPO DE BOMBA	√	√	√	R-DRO-CUEBOMBA
KIT DE IMPULSORES	√			R-DRO-KITIMP
		√		R-DRO-KITIMP2
			√	R-DRO-KITIMP3
KIT DE VÁLVULAS CHECK	√	√	√	R-DRO-KITVCHECK
SELLO MECÁNICO	√	√	√	R-DRO-SELLOMEC
TANQUE DE PRESIÓN	√	√	√	R-DRO-TANQPRES
VÁLVULA 5 VÍAS	√	√	√	R-DRO-VALV.5V
VENTILADOR	√	√	√	R-DRO-VENT



REFACCIONES BOMBAS PRISMA25

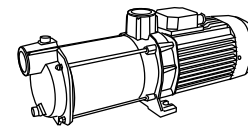

REFACCIÓN	PRISMA15-2/1115	PRISMA15-3/1115	PRISMA15-3/1220	PRISMA25-2/1115	PRISMA25-2/1220	PRISMA25-3/1115	PRISMA25-3/1220	PRISMA25-4/1220	PRISMA25-4/3220	PRISMA35N-2/1220	PRISMA35N-2/3224	PRISMA35N-3/3224	PRISMA35N-4/3224	PRISMA45N-2/1220	PRISMA45N-2/3224	PRISMA45N-3/3224	CÓDIGO	
ARANDELA	√	√	√														E190252	
	√	√	√														E215	
	√	√	√														E281	
				√	√	√	√	√	√	√	√	√	√	√	√	√	√	E142-381
				√	√	√	√	√	√	√	√	√	√	√	√	√	√	E180-20
				√	√	√	√	√	√	√								E180-44
BALERO	√	√	√														E1962	
				√	√	√	√	√	√								E1900	
				√	√	√	√	√	√	√	√	√	√	√	√	√	E1901	
						√	√	√	√	√	√	√	√	√	√	√	E1902	
BRIDA														√	√	√	E131437	
CAJA CONEXIONES	√	√	√	√	√	√	√	√	√								E111-33	
										√						√	E11100471	
CAMISA			√									√	√				E111478	
CAPACITOR	√	√							√								E136732	
								√									E2038	
							√										E2037	
				√			√										E2049	
CASQUILLO										√	√	√	√				E39320	
				√	√	√	√	√	√								E110-855	
				√	√	√	√	√	√						√	√	E138-608	
															√	√	E150686	
CLIXON	√					√											E14119	
		√	√														E10-245	
				√													E14201	
						√											E10-39	
CUERPO DE IMPULSIÓN				√	√												E150-976	
CUERPO DE ASPIRACIÓN														√	√	√	E126-878	
DIFUSOR	√	√	√														E10489	
				√	√	√	√	√	√								E110-112	
				√	√	√	√	√	√								E110-453	
										√	√	√	√				E196-311	
															√	√	√	E127862
															√	√	√	E128564
DISTANCIADOR															√	√	E127864	
															√	√	E128129	
IMPULSOR														√	√	√	E127822	
																	E129471	
JUNTA	√	√	√	√	√	√	√	√	√								E345	
	√	√	√	√	√	√	√	√	√								E385	
				√	√	√	√	√	√	√	√	√	√	√	√	√	E4100029	
																	E41-17	
RETEN				√	√	√	√	√	√	√	√	√	√	√	√	√	E342	
				√	√	√	√	√	√								E349	
SELLO MECANICO				√	√												E402/502	
																	E422/539	
TAPA CAJA CONEXIONES	√	√	√	√	√	√	√	√	√	√	√	√	√	√	√	√	E10515	
TAPA DIFUSOR				√	√	√	√	√	√	√	√	√	√	√	√	√	E135136	
TAPA VENTILADOR				√	√												E110-108	
TAPON	√	√	√	√	√	√	√	√	√	√	√	√	√	√	√	√	E10433	
																	E10528	
										√	√	√	√	√	√	√	E10150	
										√	√	√	√	√	√	√	E10338	
TIRANTE																	E390	
TORNILLO				√	√	√	√	√	√	√	√	√	√	√	√	√	E290-17	
VENTILADOR				√	√												E14	
						√	√	√	√	√	√	√	√	√	√	√	E1040	
																	E1041	

REFACCIÓN	PRESSDRIVE 05/115	PRESSDRIVE 05/230	CÓDIGO
TARJETA CTROL	√		R-PD05-TARJELEC
KIT MEMBRANA	√	√	R-PD05-KITMEMBRANA
KIT DE O-RING	√	√	R-PD05-KITORING
MANÓMETRO	√	√	R-PD05-MANO
REGLETA	√	√	R-PD05-REGLETA

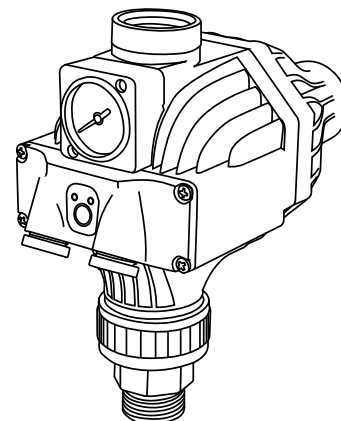

REFACCIÓN	DELTA 500-115	DELTA 750-115	DELTA 1000-115	DELTA 1000-220	DELTA 1750/1220	CÓDIGO
VENTILADOR	√	√				E146273
			√	√	√	E39019591
BALERO	√	√				E1962
			√	√	√	E1901
TAPA CAJA CONEXIONES 115V	√	√	√			E150915
TAPA CAJA CONEXIONES 220V				√	√	E10515
CAJA DE CONEXIONES	√	√	√			E150914
				√	√	E111-33
TAPA VENTILADOR	√	√				E1109-01
			√	√	√	E42210463
CAPACITOR 16μF				√	√	E2049
CAPACITOR 30μF	√	√	√			E2038
PIE/SOPORTE DE BOMBA			√	√	√	E146040
SELLO MECÁNICO	√	√				E400/500
			√	√	√	E402/502
IMPULSOR	√					E111-156
		√				E111-157
			√	√		E111-158
CUERPO BOMBA	√	√	√	√		E5221
					√	E181-23
KIT CUERPO DE BOMBA	√	√	√	√		E181-20
CUERPO INYECTOR	√					E110-154
VÁLVULA DE ASPIRACIÓN					√	E111-77
JUNTA TÓRICA INYECTOR	√	√	√	√		E336
JUNTA TÓRICA DIFUSOR	√	√	√	√		E353
JUNTA TÓRICA CUERPO BOMBA	√	√	√	√	√	E40-08
JUNTA TÓRICA SOPORTE 1750					√	E367
ASA				√	√	E146262
SOPORTE POSTERIOR DELTA 1750					√	E110-74
SOPORTE ANTERIOR DELTA 1750					√	E110-73
TAPÓN DE PURGA	√	√	√	√	√	E10338

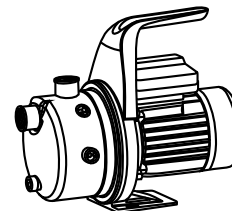
**BOMBAS DELTA1755**

VERSIÓN ESTÁNDAR		
REFACCIÓN	CÓDIGO	CANTIDAD REQUERIDA
BUJE	E134-917	4
DIFUSOR	E110-80	3
IMPULSOR	E130-923	3
CAJA DIFUSOR	E108661	1

VERSIÓN ESTÁNDAR

VERSIÓN ALTERNATIVA		
REFACCIÓN	CÓDIGO	CANTIDAD REQUERIDA
BUJE	E194-966	3
DIFUSOR	E110-80	3
IMPULSOR	E180-19	3
BUJE INICIAL	E134-917	1
CAJA DIFUSOR	E108661	1

VERSIÓN ALTERNATIVA

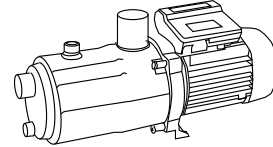
**TECNO15-3/1115**

REFACCIÓN	CÓDIGO
BALERO	E1936
TAPA VENTILADOR	E10394
SELLO MECÁNICO	E400/500
TAPA DE DIFUSOR	E10490
CONDENSADOR 30uF	E2038
JUNTA P/SUCCIÓN	E41-85
JUNTA P/CUERPO BOMBA	E41-86
SUCCIÓN	E182-440
CUERPO DE BOMBA	E182-453

TECNO15-3/1115

VERSIÓN ESTÁNDAR		
REFACCIÓN	CÓDIGO	CANTIDAD REQUERIDA
BUJE	E126-102	4
DIFUSOR	E10489	3
IMPULSOR	E126-068	3

VERSIÓN ALTERNATIVA		
REFACCIÓN	CÓDIGO	CANTIDAD REQUERIDA
BUJE	E10507	4
DIFUSOR	E10489	3
IMPULSOR	E5938	3

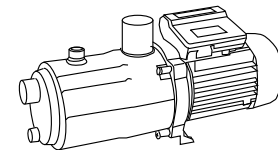
**TECNOPLUS25-4N/M**

REFACCIÓN	CÓDIGO
BALERO DELANTERO	E1900
BALERO TRASERO	E1901
SELLO MECÁNICO	E422/539
VENTILADOR	E1040
TAPA DE VENTILADOR	E10433
CAJA DE CONEXIONES	E155843
TARJETA DE POTENCIA	E155814
TARJETA DE SEÑAL	E155813
TAPA DE CONEXIONES	E155820
TARJETA DE CONTROL	E155801
JUNTA TÓRICA	E40-66
GUÍA	E11-607
VÁLVULA	E166076
RESORTE	E146123
JUNTA TÓRICA	E40-30
RACORD	E136370
MANÓMETRO	E171046
ESCUDO TECNOPLUS25-4	E202203
CUERPO ASPIRACION TECNOPLUS25-4	E18200440
CUERPO BOMBA TECNOPLUS25-4	E18200533
ACOPLAMIENTO TECNOPLUS25-4	E155821
CABLE TECNOPLUS25-4	E1855

VERSIÓN ESTÁNDAR		
REFACCIÓN	CÓDIGO	CANTIDAD REQUERIDA
BUJE	E129-638	5
DIFUSOR	E110-112	4
IMPULSOR	E129471	4

VERSIÓN ESTÁNDAR

VERSIÓN ALTERNATIVA		
REFACCIÓN	CÓDIGO	CANTIDAD REQUERIDA
BUJE INICIAL	E192166	1
DIFUSOR	E110-112	4

VERSIÓN ALTERNATIVA

REFACCIÓN	KIT NMULTI 35-3	KIT NMULTI 35-4	KIT NMULTI 35-5	CÓDIGO
VENTILADOR	√			E1041
		√	√	E35022
BALERO INFERIOR	√			E1931
BALERO SUPERIOR	√			E1901
BALERO INFERIOR		√	√	E6306
BALERO SUPERIOR		√	√	E1912
TAPA VENTILADOR	√			E10528
		√	√	E18-323
SELLO MECÁNICO	√	√	√	E422/539
CAJA DE CONEXIONES	√			E11100471
		√	√	E35017
TAPÓN DE PURGA	√	√	√	E11-573
KIT DE BRIDAS	√	√	√	E131437
SUCCIÓN	√	√	√	E133-224
DESCARGA	√			E133-225
		√	√	E133-226

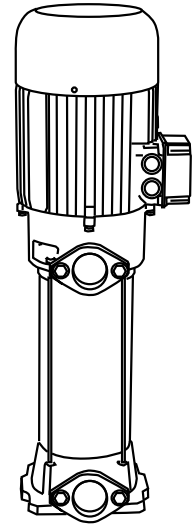
BOMBAS MULTI35-3

VERSIÓN ESTÁNDAR		
REFACCIÓN	CÓDIGO	CANTIDAD REQUERIDA
BUJE	E110-855	4
DIFUSOR	E196-311	3
BUJE INICIAL	E111-862	NA
IMPULSOR	E125463	3

VERSIÓN ALTERNATIVA		
REFACCIÓN	CÓDIGO	CANTIDAD REQUERIDA
BUJE	E191-885	2
DIFUSOR	E196-311	3
BUJE INICIAL	E110-855	1
BUJE FINAL	E110-855	1

BOMBAS MULTI35-4

VERSIÓN ESTÁNDAR		
REFACCIÓN	CÓDIGO	CANTIDAD REQUERIDA
BUJE	E110-855	4
DIFUSOR	E196-311	3
BUJE INICIAL	E111-862	1
IMPULSOR	E125463	4

VERSIÓN ALTERNATIVA		
REFACCIÓN	CÓDIGO	CANTIDAD REQUERIDA
BUJE	E191-885	3
DIFUSOR	E196-311	4
BUJE FINAL	E110-855	1

BOMBAS MULTI35-5

VERSIÓN ESTÁNDAR		
REFACCIÓN	CÓDIGO	CANTIDAD REQUERIDA
BUJE	E110-855	5
DIFUSOR	E196-311	5
BUJE INICIAL	E111-862	1
IMPULSOR	E125463	5

VERSIÓN ALTERNATIVA		
REFACCIÓN	CÓDIGO	CANTIDAD REQUERIDA
BUJE	E191-885	4
DIFUSOR	E196-311	5
BUJE FINAL	E110-855	1

VERSIÓN ESTÁNDAR

VERSIÓN ALTERNATIVA



REFACCIÓN	KIT NMULTI 45-3	KIT NMULTI 45-4	KIT NMULTI 45-5	CÓDIGO
DIFUSOR	√	√	√	E127862
DIFUSOR CON COJINETE			√	E128564
IMPULSOR	√	√	√	E127822
DISTANCIADOR	√	√	√	E128129
DISTANCIADOR SUPERIOR		√	√	E128725
DISTANCIADOR INTERMEDIO	√	√	√	E127864
CASQUILLO AC. INOXIDABLE			√	E150686
BALERO INFERIOR	√			E1931
BALERO SUPERIOR	√			E1901
BALERO INFERIOR		√	√	E6306
BALERO SUPERIOR		√	√	E1912
SELLO MECÁNICO	√	√	√	E422/539
VENTILADOR	√			E1041
		√	√	E35022
TAPA VENTILADOR	√			E10528
		√	√	E18-323
CAJA DE CONEXIONES	√			E11100471
		√	√	E35017
TAPÓN DE PURGA	√	√	√	E11-573
KIT DE BRIDAS	√	√	√	E131437
SUCCIÓN	√	√	√	E133-224
DESCARGA	√			E133-225
		√	√	E133-226

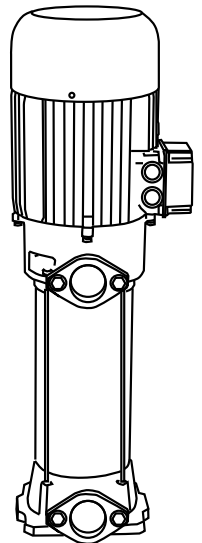

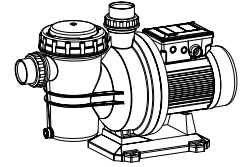

REFACCIÓN	SILEN-I-33-115	SILEN-I-33-220	SILEN-I-50-115	SILEN-I-50-220	SILEN-I-100-115	SILEN-I-100-220	CÓDIGO
AMORTIGUADOR	√	√	√	√	√	√	E6016
ARANDELA	√	√	√	√	√	√	E190252
BALERO 6201 2RS	√	√	√	√	√	√	E1962
CAPACITOR	√		√		√		E189-157
CLIXON					√		E10-153
			√				E14119
						√	E10-245
	√						E10000241
CUEPO DE BOMBA	√	√	√	√	√	√	E202998
CUERPO DE IMPULSIÓN	√	√	√	√	√	√	E137438
DIFUSOR	√	√	√	√	√	√	E11000412
FILTRO	√	√	√	√	√	√	E11000819
IMPULSOR	√	√					E5835
			√	√			E5836
					√	√	E11100512
JUNTA	√	√	√	√	√	√	E350
	√	√	√	√	√	√	E198624
	√	√	√	√	√	√	E316
LLAVE	√	√	√	√	√	√	E127995
PIE	√	√	√	√	√	√	E10466
RACOR	√	√	√	√	√	√	E10464-10020
RETEN	√	√	√	√	√	√	E142698
SELLO MECANICO	√	√	√	√	√	√	E74580
TAPA CAJA CONEXIONES				√			E135136
	√		√		√		E156140
TAPA DE MOTOR	√	√	√	√	√	√	E154447
TAPON	√	√	√	√	√	√	E10338
	√	√	√	√	√	√	E390
TUERCA FILTRO	√	√	√	√	√	√	E126987

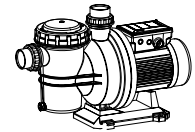

REFACCIÓN	SILEN-50/1115	SILEN 75/1115	SILEN 100/1115	SILEN 100/1220	SILEN 150/1220	SILEN2 200/1220	SILEN2 200/3220	SILEN2 300/1220	SILEN2 300/3220	CÓDIGO
CUERPO BOMBA	√	√	√	√	√	√	√	√	√	E10423 E133380
TAPA FILTRO	√	√	√	√	√	√	√	√	√	E133347 E129423
TUERCA DE FILTRO	√	√	√	√	√	√	√	√	√	E133348 E133381
FILTRO	√	√	√	√	√	√	√	√	√	E11-820 E11-822
IMPULSOR 50	√									E5738
IMPULSOR 75		√								E5739
IMPULSOR 100			√	√						E5740
IMPULSOR 150					√					E111-425
IMPULSOR 200M						√				E111-93
IMPULSOR 200T							√			E111-97
IMPULSOR 300M								√		E111-94
IMPULSOR 300T									√	E111-98
DIFUSOR	√	√	√	√						E10429 E10430 E11-428
DIFUSOR 200						√	√			E110-09
DIFUSOR 300								√	√	E110-10
SELLO MECÁNICO	√	√	√	√	√	√	√	√	√	E74583
PIE DE BOMBA	√	√	√	√	√	√	√	√	√	E10431 E11-339
BALERO DELANTERO	√	√	√	√	√	√	√	√	√	E1901 E1902 B6205
BALERO TRASERO	√	√	√	√	√	√	√	√	√	E1901 B6205
KIT CAJA-TAPA CONEXIONES					√	√				E128141 E128138
CAJA DE CONEXIONES				√						E111-33 E136411
TAPA P/CAJA CONEXIONES								√	√	E156140 E10515
CAJA CONEX. TRIFÁSICO							√		√	E11100471
CAPACITOR 30mF	√	√	√			√				E2038
CAPACITOR 16mF				√						E21-12
CAPACITOR 25mF					√					E2037
CAPACITOR 60mF								√		E15210
TAPA VENTILADOR	√	√	√	√	√	√	√	√	√	E10433 E10528 E11-324
VENTILADOR	√	√	√	√	√	√	√	√	√	E1040 E1041 E10367 E14000
KLIXON	√	√	√	√		√				E-198811 E14011
JUNTA PLANA DIFUSOR	√	√	√	√	√	√	√	√	√	E324
JUNTA TÓRICA	√	√	√	√	√					E391
ORING CUERPO BOMBA						√	√	√	√	E40-37
JUNTA TÓRICA RACOR	√		√	√	√	√	√	√	√	E350 E399
JUNTA TÓRICA FILTRO	√		√	√	√					E214330
SOPORTE BOMBA-MOTOR	√		√	√	√	√	√	√	√	E129420 E129424
KIT RACOR	√		√	√	√					RACORSILEN
KIT RACOR						√	√	√	√	RACORSILEN2
TAPON DE CEBADO	√	√	√	√	√	√	√	√	√	E10338

REFACCIÓN	SILEN75 -S-1115	SILEN100 -S-1115	SILEN100 -S-1220	SILEN150 -S-1220	CÓDIGO
AMORTIGUADOR	√	√	√	√	E6016
ARANDELA	√	√	√	√	E142-381
BALERO	√	√	√	√	E1963
CAJA CONEXIONES 1F	√	√	√	√	E133890
CAJA CONEXIONES 3F					E111478
CAPACITOR 16MF			√		E189-153
CAPACITOR 25MF				√	E189-155
CAPACITOR 60MF					E189-159
CLIXON			√		E14011
CUERPO BOMBA	√	√	√	√	E202-981
	√				E10429
DIFUSOR		√	√		E10430
				√	E11-428
EMPAQUE CAJA TRIFASICA					E122-968
FILTRO	√	√	√	√	E11-820
	√				E5739
IMPULSOR		√	√		E5740
				√	E111-425
JUNTA PLANA DIFUSOR	√	√	√	√	E324
JUNTA TÓRICA	√	√	√	√	E350
JUNTA TÓRICA FILTRO	√	√	√	√	E214330
	√	√	√	√	E391
JUNTA TÓRICA RACOR	√	√	√	√	E399
	√	√	√	√	E300
KIT RACOR	√	√	√	√	RACORSILENS
LLAVE TAPA CESTO FILRTO	√	√	√	√	E127995
ORING TAPON CEBADO	√	√	√	√	E390
PIE DE BOMBA	√	√	√	√	E10431
PROTECTOR	√	√	√	√	E198-812
RACOR	√	√	√	√	E130147
	√	√	√	√	E127482
RETEN	√	√	√	√	E142-699
	√	√	√	√	E349
ROSCA	√	√	√	√	E125-561
SELLO MECANICO	√	√	√	√	E74583
SOPORTE BOMBA-MOTOR	√	√	√	√	E129420
TAPA CC 1F	√	√			E156140
			√	√	E135136
TAPA CLIXON				√	E10035
TAPA FILTRO	√	√	√	√	E11-457
					E129423
TAPA MOTOR	√	√	√	√	E154-835
TAPA VENTILADOR	√	√	√	√	E130-122
TAPON 1/4"	√	√	√	√	E10338
TUERCA RACOR	√	√	√	√	E127465
	√	√	√	√	E10464-10020
VENTILADOR	√	√	√	√	E1040

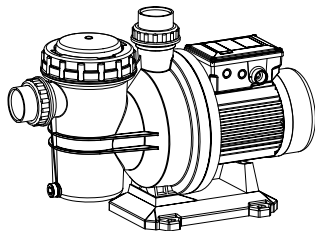

REFACCIÓN	SILEN200 -S2-1220	SILEN200 -S2-3220	SILEN300 -S2-1220	SILEN300 -S2-3220	CÓDIGO
AMORTIGUADOR	√	√	√	√	E9321
			√	√	E6047
ARANDELA	√	√	√	√	E142-381
			√	√	E70-238
BALERO	√	√	√	√	E1964
	√	√	√	√	E1963
CAJA DE CONEXIONES			√	√	E136411
CAPACITOR			√		E189-159
	√				E189-157
CLIXON	√				E14201
			√	√	E-198811
DIFUSOR	√	√			E110-09
			√	√	E110-10
IMPULSOR	√	√			E111-93
			√	√	E111-94
JUNTA	√	√	√	√	E324
	√	√	√	√	E40-37
	√	√	√	√	E399
	√	√	√	√	E204888
	√	√	√	√	E300
LLAVE	√	√	√	√	E127-994
RACOR	√	√	√	√	E127465
RETEN	√	√	√	√	E142-699
	√	√	√	√	E342
			√	√	E41-118
SELLO MECANICO	√	√	√	√	E74583
TAPA CAJA CONEXIONES	√				E135136
	√	√			E156140
TAPA DE MOTOR	√	√	√	√	E149-001
TAPA VENTILADOR			√		E202-564
TAPON	√	√	√	√	E10338
	√	√	√	√	E390
TORNILLO		√		√	E110-764
VENTILADOR	√	√		√	E1041
			√		E10367

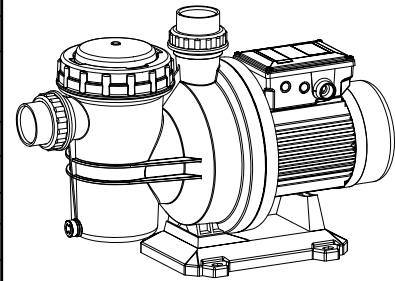

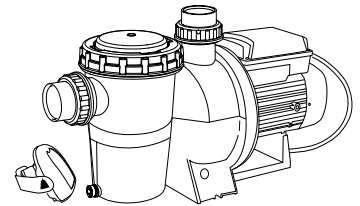

REFACCIÓN	SILENPLUS 2M	SILENPLUS 1M/1115	CÓDIGO
ACOPAMIENTO	√	√	E155821
AMORTIGUADOR	√		E9321
		√	E6016
ARANDELA	√	√	E142-381
BALERO	√	√	E1963
	√		E1964
CABLE DE ALIMENTACIÓN	√	√	E1855
CAJA DE VARIADOR	√	√	E155843
CAPACITOR 820MF/400V	√	√	E38122
CARTA ELECTRÓNICA	√	√	E155801
CONTROL	√	√	R-SILPLUS-CONTROL
CUERPO DE BOMBA		√	E202-981
CUERPO DE BOMBA < 2015	√		E133380
CUERPO DE BOMBA 2016 >	√		E11-337
DIFUSOR	√		E110-09
		√	E10430
FILTRO	√		E11-822
		√	E11-820
IMPULSOR	√		R-SILPL2M-IMPULS
		√	E5848
JUNTA	√	√	E324
JUNTA TÓRICA	√	√	E300
KIT TUERCA Y RACOR		√	E10474
LLAVE PARA FILTRO	√		E127-994
		√	E127995
O-RING DE FILTRO	√		E204888
		√	E214330
O-RING DE RACOR	√	√	E399
		√	E350
O-RING PARA CUERPO DE BOMBA	√		E40-37
		√	E391
O-RING TAPÓN DE CEBADO	√	√	E390
PIE	√		E11-339
		√	E10431
RACORD		√	E10464-10020
	√	√	E130147
REGLETA	√	√	R-PD05-REGLETA
		√	E142-699
RETÉN	√		E342
		√	E349
SELLO MECANICO	√	√	E74583
SOPORTE	√		E129424
		√	E129420
TAPA DE MOTOR	√		E149-001
		√	E154-835
TAPA DE VARIADOR	√	√	E155820
TAPA FILTRO	√		E129423
		√	E11-457
TAPA VENTILADOR	√		E131-639
		√	E130-122
TAPON DE CEBADO	√	√	E10338
TORNILLO DE IMPULSOR	√		E110-764
		√	E05813
TUERCA		√	E125-561
TUERCA <2015	√		E133381
TUERCA 2016>	√		E129-435
TUERCA DE RACOR	√	√	E127465
		√	E10018/10019
VENTILADOR	√		E1041
		√	E1040

REFACCIÓN	NADORSELF 300/1230	NADORSELF 400/3234	CÓDIGO
ARANDELA	√	√	E70-238
CAJA CONEXIONES	√		E136411
		√	E35017
CAPACITOR	√		E189-159
CLIXON	√		E-198811
CUERPO BOMBA	√	√	E111-572
DESCARGA	√	√	E110-594
IMPULSOR	√		E157775
		√	E157774
JUNTA	√	√	E125996
	√	√	E300
PROTECTOR DE CLIXON	√		E198-812
RETEN	√	√	E142-699
	√	√	E342
	√	√	E41-118
SELLO MECANICO	√	√	E414/514
	√	√	E74583
SOPORTE BOMBA 2011	√	√	E184515
SUCCIÓN	√	√	E110-593
TAPA CAJA CONEXIONES	√		E156140
TAPA VENTILADOR	√	√	E202-564
TORNILLO	√	√	E110-764
VENTILADOR	√	√	E10367

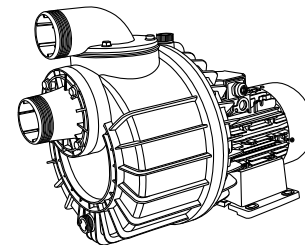

REFACCIÓN	KIT NC RL	KIT NC CL	KIT NC CH	KIT NC RH	CÓDIGO
BRIDA P/LINER	√	√			E11-778
SOP. POSTERIOR P/LINER	√	√			E11-779
SOPORTE HORMIGON			√	√	E133813
JUNTA DE GOMA 10 mm	√	√	√	√	E41-123
JUNTA DE GOMA 2 mm			√	√	E129055
JUNTA DE GOMA 1 mm			√	√	E129056
ARO SOPORTE	√	√	√	√	E11-773
TUBO CAPILAR 25 m	√	√	√	√	E31-33
RACORD	√	√	√	√	E129058
JUNTA DE ESPUMA	√	√	√	√	E41-124
KIT NC HORM.+ LINER POS.	√	√	√	√	E146558
KIT CARAT. REDONDA COMP.	√			√	E128188
KIT CARAT. CUADRADA COMP.		√	√		E128189
BOTÓN PULS. y TUERCA/ N.C.	√	√	√	√	R-KIT-NC-BOTON

REFACCIÓN	WIPER 200/1230	WIPER 300/3234	CÓDIGO
CUERPO ASPIRACIÓN	√	√	E111-812
CUERPO IMPULSIÓN	√	√	E124156
IMPULSOR	√		E129991
		√	E151787
SELLO MECÁNICO	√	√	E74580
PIE DE BOMBA	√	√	E10199
BALERO TRASERO		√	B6205
	√		E1901
BALERO DELANTERO		√	B6205
	√		E1902
CAPACITOR	√		E2037
TAPA VENTILADOR	√		E10528
VENTILADOR		√	E11-324
	√		E10367
KIT RACORSUCCIÓN/DESCARGA	√	√	E1041
JUNTA TÓRICA CUERPO DE BOMBA	√	√	RACORSILEN2
TAPÓN DE PURGA	√	√	E40-70
CAJA	√	√	E10338
TAPA	√		E133890
		√	E135136
		√	E136411

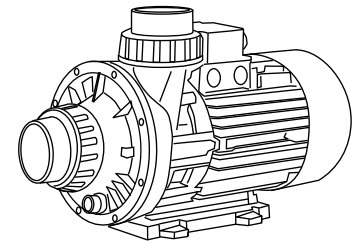

REFACCIÓN	NOXPLUS100-1230	CÓDIGO
ARANDELA	√	E142-381
BALERO	√	E1963
CAPACITOR	√	E38122
CAJA DE VARIADOR	√	E155843
CUERPO DE BOMBA	√	E133346
DIFUSOR	√	E10430
EMPAQUE	√	E324
FILTRO	√	E11-820
IMPULSOR	√	E-10486
LLAVE	√	E127995
O-RING	√	E391
	√	E214330
	√	E390
	√	E350
	√	E10431
PIE DE BOMBA	√	E10431
KIT TARJETA Y FIJADOR	√	E-28-154
RACOR	√	E10463
REGLETA	√	R-PD05-REGLETA
RETEN	√	E142-699
	√	E349
SELLO MECANICO	√	E74583
SOPORTE	√	E129420
TAPA DE FILTRO	√	E133347
TAPA DE MOTOR	√	E154-835
TAPA DE VENTILADOR	√	E10433
TAPA VARIADOR	√	E155820
TAPON	√	E10338
TARJETA DE CONTROL	√	E155801
TUERCA	√	E133348
	√	E10464
VENTILADOR	√	E1040

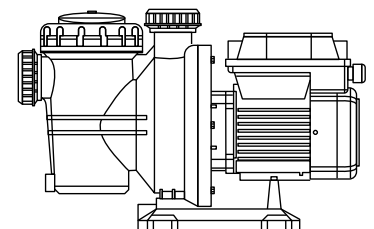

REFACCIÓN	ACUARIA 07N					ACUARIA 07S					CÓDIGO
	2/115A	3/115A	3/220A	4/115A	4/220A	2/115A	3/115A	3/220A	4/115A	4/220A	
ARANDELA	√	√	√	√	√	√	√	√	√	√	E281
	√	√	√	√	√	√	√	√	√	√	E190252
BALERO	√	√	√	√	√	√	√	√	√	√	E1962
BUJE	√	√	√	√	√	√	√	√	√	√	E126-102
CABLE CONCETOR		√		√			√		√		E156848
			√					√			E152677
	√				√	√				√	E156847
CAPACITOR			√					√			E156634
					√					√	E2049
				√							E2068
	√	√				√	√				E2038
CONEC.TAPA MOT (4CAB.)	√	√	√	√	√	√	√	√	√	√	E152708
DIFUSOR	√	√	√	√	√	√	√	√	√	√	E10489
FLOTADOR	√	√	√	√	√	√	√	√	√	√	E197290
IMPULSOR	√	√	√	√	√	√	√	√	√	√	E126-068
JUNTA CUERPO DESC.	√	√	√	√	√	√	√	√	√	√	E152885
JUNTA ENVOLVENTE	√	√	√	√	√						E132523
JUNTA TORICA						√	√	√	√	√	E-210633
PASADOR PARA PIE	√	√	√	√	√						E131155
PIE	√	√	√	√	√						E132538
SELLO MECANICO	√	√	√			√	√	√			E400/500
				√	√				√	√	E80-74567
TAPA INFERIOR	√	√	√	√	√						E132537
						√	√	√	√	√	E-208586
TAPA SUPERIOR	√	√	√	√	√						E132522
						√	√	√	√	√	E-208949
KIT TAPA 115 VOLTS	√	√		√							E168105
TAPON BASE DE SUC.	√	√	√	√	√						E10080

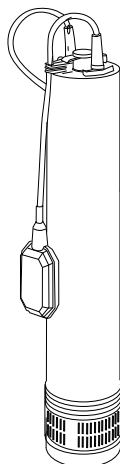

REFACCIÓN	ACUARIA07-3/1220A	ACUARIA07-4/1220A	ACUARIA07-2/1115A	ACUARIA07-3/1115A	ACUARIA07-4/1115A	CÓDIGO
CAPACITOR 30uF			√	√		E2038
CAPACITOR 40uF					√	E2068
CAPACITOR 12uF	√					E21-09
CAPACITOR 16uF		√				E21-10
BALERO SUPERIOR	√	√	√	√	√	E1936
BALERO INFERIOR	√	√	√	√	√	E1936
SELLO MEC. INFERIOR	√	√	√	√	√	E80-74567
SELLO MEC. SUPERIOR	√	√	√	√	√	E400/500
TAPA DIFUSOR	√	√	√	√	√	E10490
PIE	√	√	√	√	√	E10318
CONECTOR 07/115V			√	√	√	E7144
CONECTOR 07/220V	√	√				E191-05
FLOTADOR	√	√	√	√	√	E191-06

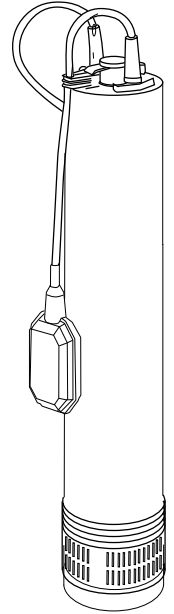

BOMBAS ACUARIA07-2

VERSIÓN ESTÁNDAR		
REFACCIÓN	CÓDIGO	CANTIDAD REQUERIDA
BUJE	E126-102	3
DIFUSOR	E10489	2
IMPULSOR	E126-068	2

VERSIÓN ALTERNATIVA		
REFACCIÓN	CÓDIGO	CANTIDAD REQUERIDA
BUJE	E10507	2
DIFUSOR	E10489	2
IMPULSOR	E5938	2

BOMBAS ACUARIA07-3

VERSIÓN ESTÁNDAR		
REFACCIÓN	CÓDIGO	CANTIDAD REQUERIDA
BUJE	E126-102	4
DIFUSOR	E10489	3
IMPULSOR	E126-068	3

VERSIÓN ALTERNATIVA		
REFACCIÓN	CÓDIGO	CANTIDAD REQUERIDA
BUJE	E10507	3
DIFUSOR	E10489	3
IMPULSOR	E5938	3

BOMBAS ACUARIA07-4

VERSIÓN ESTÁNDAR		
REFACCIÓN	CÓDIGO	CANTIDAD REQUERIDA
BUJE	E126-102	5
DIFUSOR	E10489	4
IMPULSOR	E126-068	4

VERSIÓN ALTERNATIVA		
REFACCIÓN	CÓDIGO	CANTIDAD REQUERIDA
BUJE	E10507	4
DIFUSOR	E10489	4
IMPULSOR	E5938	4

VERSIÓN ESTÁNDAR

VERSIÓN ALTERNATIVA

REFACCIÓN	ACUARIA17-3/1220A	ACUARIA17-4/1220A	CÓDIGO
CAPACITOR 16uF	√		E2008
BALERO SUPERIOR	√	√	E1900
BALERO INFERIOR	√	√	E1954
SELLO MEC. SUPERIOR	√	√	E415/515
SELLO MEC. INFERIOR	√	√	E422/539
TAPA DIFUSOR	√	√	E110-78
DIFUSOR	√	√	E110-80
DISTANCIADOR	√	√	E110-81
DISTANCIADOR INICIAL	√	√	E195-60
DISTANCIADOR ALTERN.	√	√	E194-966
IMPULSOR	√	√	E130-923
IMPULSOR ALTERNATIVA	√	√	E180-19
PIE	√	√	E110-30
CONECTOR	√	√	E7144
CONJUNTO FLOTADOR	√	√	E191-06

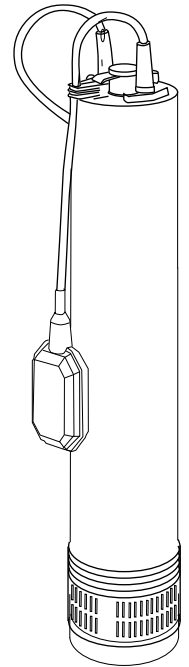

BOMBAS ACUARIA17-3

VERSIÓN ESTÁNDAR		
REFACCIÓN	CÓDIGO	CANTIDAD REQUERIDA
BUJE	E134-917	4
DIFUSOR	E110-80	3
IMPULSOR	E130-923	3

VERSIÓN ALTERNATIVA		
REFACCIÓN	CÓDIGO	CANTIDAD REQUERIDA
BUJE	E194-966	3
DIFUSOR	E110-80	3
IMPULSOR	E180-19	3

BOMBAS ACUARIA17-4

VERSIÓN ESTÁNDAR		
REFACCIÓN	CÓDIGO	CANTIDAD REQUERIDA
BUJE	E134-917	5
DIFUSOR	E110-80	4
IMPULSOR	E130-923	4

VERSIÓN ALTERNATIVA		
REFACCIÓN	CÓDIGO	CANTIDAD REQUERIDA
BUJE	E194-966	4
DIFUSOR	E110-80	4
IMPULSOR	E180-19	4

VERSIÓN ESTÁNDAR

VERSIÓN ALTERNATIVA



REFACCIÓN	ACUARIA27-3/1220A	ACUARIA27-3/3220	ACUARIA27-4/1220	
CAPACITOR 30uF		N/A	√	E2038
BALERO SUPERIOR	√	√	√	E1900
BALERO INFERIOR	√	√	√	E1954
SELLO MEC. SUPERIOR	√	√	√	E415/515
SELLO MEC. INFERIOR	√	√	√	E422/539
TAPA DIFUSOR	√	√	√	E110-108
DIFUSOR	√	√	√	E110-112
DISTANCIADOR	√	√	√	E129-638
DISTANCIADOR INICIAL	√	√	√	E192166
IMPULSOR	√	√	√	E129471
PIE	√	√	√	E110-30
CONECTOR	√	√	√	E7144
CONJUNTO FLOTADOR	√			E191-06

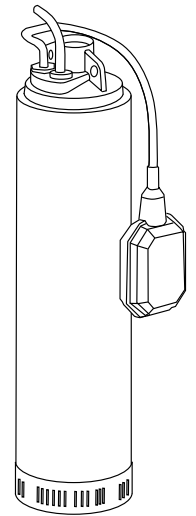

BOMBAS ACUARIA27-3

VERSIÓN ESTÁNDAR		
REFACCIÓN	CÓDIGO	CANTIDAD REQUERIDA
BUJE	E129-638	5
DIFUSOR	E110-112	4
IMPULSOR	E129471	4

VERSIÓN ALTERNATIVA		
REFACCIÓN	CÓDIGO	CANTIDAD REQUERIDA
BUJE INICIAL	E192166	1
DIFUSOR	E110-112	4

BOMBAS ACUARIA27-4

VERSIÓN ESTÁNDAR		
REFACCIÓN	CÓDIGO	CANTIDAD REQUERIDA
BUJE	E129-638	5
DIFUSOR	E110-112	4
IMPULSOR	E129471	4

VERSIÓN ALTERNATIVA		
REFACCIÓN	CÓDIGO	CANTIDAD REQUERIDA
BUJE INICIAL	E192166	1
DIFUSOR	E110-112	4

VERSIÓN ALTERNATIVA



REFACCIÓN	VIGILA 350-1115A	VIGILEX 600-1115A	CÓDIGO
KIT CABLE 10M.	√	√	R-VIG.-CABLE10M
RACORD	√	√	R-VIG.-RACOR
KIT CUERPO	√	√	R-VIG.-KIT.CUERPO
KIT CONDENSADOR	√	√	R-VIG.-K.CAPACITOR
KIT HIDRÁULICO	√		R-VIGILA-K.HIDRAU
		√	R-VIGILEX-K.HIDRAU
KIT ASPIRACIÓN	√		R-VIGILA-K.ASPIRA
		√	R-VIGILEX-K.ASPIRA
ASA	√	√	R-VIG-ASA

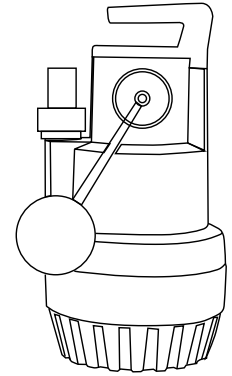

REFACCIÓN	DRAIN 100A/115	DRAINEX 100A/115	CÓDIGO
PIE DE BOMBA	√		E10272
		√	E7025
IMPULSOR		√	E7718
	√		E7717
SELLO MECÁNICO SUPERIOR	√	√	E402/502
SELLO MECÁNICO INFERIOR	√		E402/502
		√	E80-74552
BALERO INFERIOR	√	√	E1901
BALERO SUPERIOR	√	√	E1936
CAPACITOR 30uF en 115v	√	√	E2038
KIT DE CABLE CONECTOR	√	√	E7666
JUNTA TORICA SUPERIOR	√	√	E330

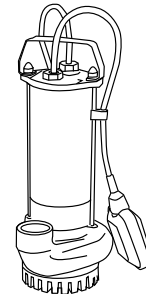

REFACCIÓN	DRAINEX 200A/1115	DRAINEX 200A/1220	DRAINEX 200/3220	DRAINEX 201/3220	DRAINEX 201A/1115	DRAINEX 201A/1220	DRAINEX 202/3220	DRAINEX 202A/1220	CÓDIGO
CAPACITOR 16uF		√				√		√	E2049
CAPACITOR 30uF	√				√				E2038
SELLO MECÁNICO	√	√	√	√	√	√	√	√	E80-74552
		√	√						E132-145
IMPULSOR				√	√	√			E132-144
							√	√	E132-104
KIT FLOTADOR MONOFÁSICO 220Volts		√				√		√	E133-118
KIT CONECTOR TRIFÁSICO			√	√			√		E133-183
KIT FLOTADOR MONOFÁSICO 115volts	√				√				E133-201
BALERO SUPERIOR	√	√	√	√	√	√	√	√	E1901
BALERO INFERIOR	√	√	√	√	√	√	√	√	E1901
PIE DE BOMBA	√	√	√	√	√	√	√	√	E17111
JUNTA TORICA	√	√	√	√	√	√	√	√	E40-16
JUNTA CODO DESCARGA	√	√	√	√	√	√	√	√	E41-22

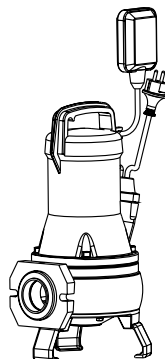

REFACCIÓN	DRAINOR 180/1220A	DRAINOR 200/1220A	DRAINOR /1220A	CÓDIGO
ARANDELA			√	E142-381
BALERO 6202	√	√	√	E1901
BALERO 6303	√	√	√	E6303
CABLE / FLOTADOR	√	√	√	E133-201
CUCHILLA	√			E130-120
CODO DE DESCARGA	√	√	√	E132-149
CAPACITOR 50 MF	√	√	√	E82-1443
CAPACITOR 16 MF	√		√	E2049
CAPACITOR 25 MF		√		E2037
CAJA DE CONEXIONES	√			E110-476
		√	√	E11000475
CLIXON	√	√	√	E174840
IMPULSOR	√		√	E132-180
		√		E132-179
JUNTA TORICA	√	√	√	E40-16
JUNTA TORICA			√	E40-52
JUNTA CODO DE DESCARGA	√	√	√	E41-22
O-RING PARA CONECTOR	√	√	√	E40-17
PASADOR	√	√	√	E70-06
RESISTENCIA DE POTENCIA	√	√	√	E301820
SELLO MECANICO	√	√	√	E80-74552
TRITURADOR	√			E130-121

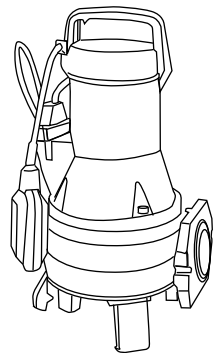
REFACCIONES BOMBAS DRAINEX400 / 500 / 600

REFACCIÓN	DRAINEX 400/3230	DRAINEX 401/3230	DRAINEX 500/3230	DRAINEX 501/3230	DRAINEX 600/3230	DRAINEX 601/3230	CÓDIGO
PIE DE BOMBA					√		E129742
	√	√	√	√			E129738
IMPULSOR	√						E138907
		√					E138908
			√				E138909
				√			E138910
					√		E138911
						√	E134112
SELLO MECÁNICO INFERIOR	√	√	√	√	√	√	E80-75227
SELLO MECÁNICO SUPERIOR	√	√	√	√	√	√	E80-75226
JUNTA TORICA POS.- 21	√	√	√	√	√	√	E4055
JUNTA TORICA POS.- 14	√	√	√	√	√	√	E129800
JUNTA TORICA POS.- 19	√	√	√	√	√	√	E4043
JUNTA TORICA POS.- 3			√	√	√	√	E129839
JUNTA TORICA POS.- 35	√	√	√	√	√	√	E302
JUNTA PARA CODO DESCARGA	√	√	√	√	√	√	E41-22
BALERO INFERIOR	√	√	√	√	√	√	E129792
BALERO SUPERIOR	√	√	√	√	√	√	E1964
CABLE CONECTOR	√	√	√	√	√	√	E131573

REFACCIÓN	SHIELD-SP-2P-6	SHIELD-SP-3P-10	CÓDIGO
MÓDULO	√		SHIELD-MDLO-1P-6
		√	SHIELD-MDLO-1P-10
BASE	√		SHIELD-BASE-2P-6
		√	SHIELD-BASE-3P-10

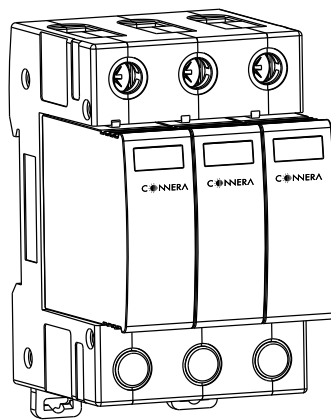

STRING BOX (CAJA DE CONEXIÓN Y PROTECCIÓN PARA ARREGLOS FOTOVOLTAICOS)

REFACCIÓN	SHIELD-SB1 -FSPDC	SHIELD-SB2 -FSPDC	CÓDIGO
DESCONECTADOR	√	√	R-SHIELDSB-DC1015
PORTA FUSIBLE	√	√	R-SHIELDSB-PF1015
FUSIBLE	√	√	R-SHIELDSB-F15
BASE	√	√	R-SHIELDSB-BASE
MÓDULO	√	√	R-SHIELDSB-MDLO

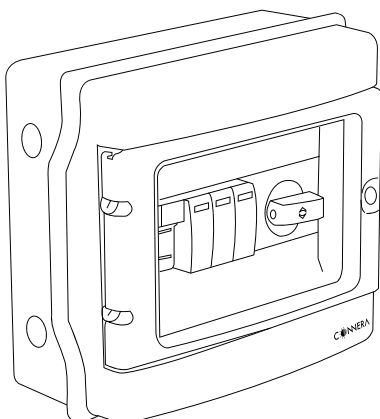

REFACCIÓN	KOLOS-2SRP-750-72	KOLOS-AP550X-48	CÓDIGO
BALERO	√		R-BALEROS-2SRP
		√	R-BALERO-AP500X48
CUERPO DE BOMBA	√		R-CUERBOM-2SRP
		√	R-CUERBOM-AP500X48
CABLE CONECTOR		√	R-CABALIM-AP500X48
	√		R-CABALIM-2SRP
COLADOR	√		R-COLADOR-2SRP
CONJUNTO DE INSTALACIÓN	√		R-KIT-INST-2SRP
		√	R-KITINST-AP500X48
CONTROLADOR	√		R-KOLOS-CTRL-75-7
		√	R-KOLOSAP-CTRL-55
CUBIERTA CUERPO		√	R-CUBCBOM-AP500X48
	√		R-CUBIERBOM-2SRP
CUBIERTA MOTOR TRASERA		√	R-CUBMOT-AP500X48
IMPULSOR	√		R-IMPULSOR-2SRP
		√	R-IMPULSOR-AP500X
ORING DE CUERPO DE BOMBA	√		R-ORINGCB-2SRP
ORING DE TAPÓN DE PURGA		√	R-ORINTPU-AP500X48
ORING Y RETÉN CUERPO/BOMBA	√		R-ORINGYRETEN-2SRP
SELLO MECÁNICO	√		R-SELLMEC-2SRP
		√	R-SELLMEC-AP500X48
SOPORTE PORTA SELLO		√	R-SOPORSM-AP500X48
TAPA CAJA DE CONEXIONES		√	R-TAPACC-AP500X48
TAPA DE VENTILADOR		√	R-TAPVENT-AP500X48
TAPÓN DE PURGA		√	R-TAPPURG-AP500X48
VENTILADOR		√	R-VENT-AP500X48

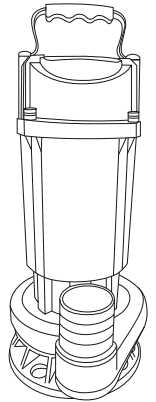
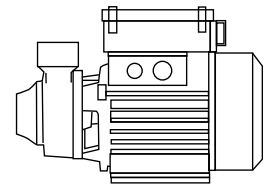
KOLOS-2SRP-750-72

KOLOS-AP550X-48

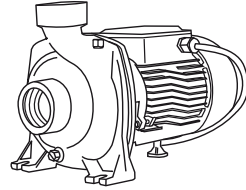
REFACCIÓN	KOLOS-CFP -1500-110	KOLOS-CFP -2200-MP	KOLOS-CFP -1500-SP	CÓDIGO
BALERO	√	√		R-CFP1500/2000-BAL
			√	R-CFP2200-BAL
CONTROLADOR	√			R-KOLO-CTRL-150-11
		√		R-KOLO-CTRL-220-30
			√	R-KOLO-CTL-150-20
CUERPO DE BOMBA	√			R-CFP1500-CUERBOM
		√		R-CFP2200-CUERBOM
			√	R-CFPK1500-CUERBOM
IMPULSOR	√			R-CFP1500-IMP
		√		R-CFP2200-IMP
			√	R-CFPK1500-IMP
ORING DE CUERPO DE BOMBA	√			R-CFP1500-EMPCB
		√		R-CFP2200-EMPCB
			√	R-CFPK1500-EMPCB
SELLO MECÁNICO	√			R-CFP1500-SELLMEC
		√		R-CFP2200-SELLMEC
			√	R-CFPK1500-SELLMEC
TAPA VENTILADOR	√			R-CFP1500-TVENT
		√		R-CFP2200-TVENT
			√	R-CFPK1500-TVENT
VENTILADOR	√			R-CFP1500-VENT
		√		R-CFP2200-VENT
			√	R-CFPK1500-VENT

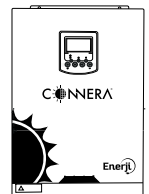

REFACCIÓN	ENERJI2400-24V/120	CÓDIGO
PANEL LED	√	R-ENERJI2400-PLED
TARJETA PARA BATERÍAS	√	R-ENERJI2400-TBAT
TARJETA DE CONTROL	√	R-ENERJI2400-CONT
TARJETA DE COMUNICACIÓN PARALELO	√	030-002-A-006
TARJETA DE CONECTORES	√	R-ENERJI2400-CONEC
TARJETA MPPT PARA ENERJI2400	√	R-ENERJI2400-TMPPT
TARJETA PUERTO DE COMUNICACIÓN PARALELO	√	R-ENERJI2400-TPCOM
VENTILADOR	√	R-ENERJI2400-VENT1
	√	R-ENERJI2400-VENT2



REFACCIÓN	POOL25 -500-48	POOL32 -900-72	CÓDIGO
KIT TAPA DE FILTRO	√	√	R-POOL-KTAPF
KIT RACOR	√	√	R-POOL-KRAC
KIT DRENADO	√	√	R-POOL-KDREN
KIT MANTENIMIENTO 25	√		R-POOL-KITMAN1
KIT MANTENIMIENTO 35		√	R-POOL-KITMAN2
PREFILTRO	√	√	R-POOL-PFIL
CUERPO BOMBA	√	√	R-POOL25-CB
BASE DE BOMBA	√	√	R-POOL-BASE
ORING DIFUSOR	√	√	R-POOL-ODIF
DIFUSOR	√	√	R-POOL25-DIF
IMPULSOR 25	√		R-POOL25-IMP
IMPULSOR 32		√	R-POOL32-IMP
CAJA DE CONEXIONES	√	√	R-POOL-CCONX
TAPA DE VENTILADOR	√	√	R-POOL-TAPVENT
VENTILADOR	√	√	R-POOL-VENT
CONTROLADOR	√		R-KOLOS-CTRL-50-4
CONTROLADOR		√	R-KOLOS-CTRL-90-7

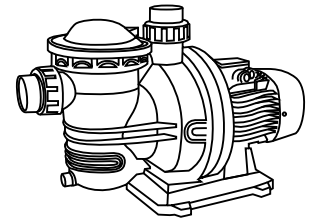

REFACCIÓN	KOLOS2-75-21-H	KOLOS3-123-110-20	KOLOS3-155-130-20	CÓDIGO
EJE HELICOIDAL	√			R-KOL2-EH21-75
BOMBA		√		KOL3-B110-123
BOMBA			√	KOL3-B130-155
MOTOR	√			KOL2-M21-36
MOTOR		√		KOL3-M110-200
MOTOR			√	KOL3-M130-200
CONTROLADOR	√			KOL2-C21-36
CONTROLADOR		√		KOL3-C110-200
CONTROLADOR			√	KOL3-C130-200

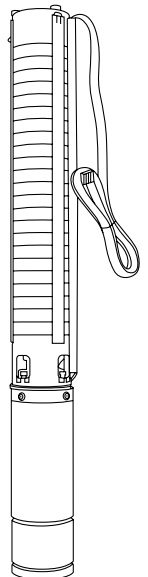

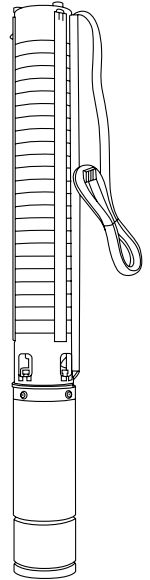

REFACCIÓN	KOL4-110-220-MP	KOL4-225-400-MP	KOL4-120-750-MP	CÓDIGO
ASIENTO DE VÁLVULA Y BUJE		√		R-KOL4-BUJASV-4000
BALERO	√			R-KOL4-BAL-6302RS
		√	√	R-KOL4-BAL-7303BP6
BOMBA	√			R-KOL4-BOM-2200
		√		R-KOL4-BOM-4000
			√	R-KOL4-BOM-7500
BUJE Y ANILLO DE SELLO TAZÓN			√	R-KOL4-BUJAST-7500
CONO Y TUERCA DE IMPULSOR			√	R-KOL4-CONTRC-7500
CONTROLADOR	√			R-CTRL-KOL4-2200
		√		R-CTRL-KOL4-4000
			√	R-CTRL-KOL4-7500
MOTOR	√			R-KOL4-MOT-2200
		√		R-KOL4-MOT-4000
			√	R-KOL4-MOT-7500
SELLO MECÁNICO	√	√	√	R-KOL4-SELM

REFACCIÓN	KOLOS3 -35-30-2	KOLOS3 -47-40-4	KOLOS3 -80-60-7	KOLOS3 -95-75-7	KOLOS3 -180-150-11	KOLOS4 -112-130-11	KOLOS4 -60-150-11	CÓDIGO
MOTOR KOLOSAL 300W-24VDC, DIAM3"	√							R-KOLOS3-MOT-30-2
MOTOR KOLOSAL 400W-48VDC, DIAM3"		√						R-KOLOS3-MOT-40-4
MOTOR KOLOSAL 600W-72VDC, DIAM3"			√					R-KOLOS3-MOT-60-7
MOTOR KOLOSAL 750W-72VDC, DIAM3"				√				R-KOLOS3-MOT-75-7
MOTOR KOLOSAL 1500W-110VDC, DIAM3"					√			R-KOLOS3-MOT-150-11
MOTOR KOLOSAL 1300W-110VDC, DIAM4"						√		R-KOLO4-MOT-130-11
MOTOR KOLOSAL 1500W-110VDC, DIAM4"							√	R-KOLO4-MOT-150-11
BOMBA KOLOSAL 35M, DIAM3"	√							R-KOLOS3-BOM-35
BOMBA KOLOSAL 47M, DIAM3"		√						R-KOLOS3-BOM-47
BOMBA KOLOSAL 80M, DIAM3"			√					R-KOLOS3-BOM-80
BOMBA KOLOSAL 95M, DIAM3"				√				R-KOLOS3-BOM-95
BOMBA KOLOSAL 180M, DIAM3"					√			R-KOLOS3-BOM-180
BOMBA KOLOSAL 112M, DIAM4"						√		R-KOLOS4-BOMB-112
BOMBA KOLOSAL 60M, DIAM4"							√	R-KOLOS4-BOMB-60
CONTROLADOR KOLOSAL 300W-24VDC	√							R-KOLOS-CTRL-30-2
CONTROLADOR KOLOSAL 400W-48VDC		√						R-KOLOS-CTRL-40-4
CONTROLADOR KOLOSAL 600W-72VDC			√					R-KOLOS-CTRL-60-7
CONTROLADOR KOLOSAL 750W-72VDC				√				R-KOLOS-CTRL-75-7
CONTROLADOR KOLOSAL 1300W-110VDC						√		R-KOLO-CTRL-130-11
CONTROLADOR KOLOSAL 1500W-110VDC					√		√	R-KOLO-CTRL-150-11
SELLLO MECANICO	√	√	√	√	√			R-KOLOS-SM3
						√	√	R-KOLOS-SM4
FLOTADOR TIPO BOYA	√	√	√	√	√	√	√	R-KOLOS-FLOTN

REFACCIÓN	KOLOSX-0.83-150/4	KOLOSX-0.83-220/7	KOLOSX-0.83-300/10	KOLOSX-0.83-400/12	KOLOSX-0.83-550/16	KOLOSX-0.83-750/22	KOLOSX-1.6-220/4	KOLOSX-1.6-400/8	KOLOSX-2.7-550/8	KOLOSX-2.7-750/11	KOLOSX-2.7-1100/13	KOLOSX-2.7-1500/17	KOLOSX-4.1-300/3	KOLOSX-4.1-400/4	KOLOSX-4.1-550/6	KOLOSX-6.6-1100/7	KOLOSX-6.6-1500/9	KOLOSX-8.8-1100/5	KOLOSX-8.8-1300/6	CÓDIGO																		
	BOMBA	√	√	√	√	√	√	√	√	√	√	√	√	√	√	√	√	√	√		√	BSUM-0.83-4P-T1	BSUM-0.83-7P-T1	BSUM-0.83-10P-T1	BSUM-0.83-12P-T1	BSUM-0.83-16P-T1	BSUM-0.83-22P-T1	BSUM-1.6-4P-T1	BSUM-1.6-8P-T1	BSUM-2.7-8P-T1	BSUM-2.7-11P-T1	BSUM-2.7-13P-T1	BSUM-2.7-17P-T1	BSUM-4.1-3P-T1	BSUM-4.1-4P-T1	BSUM-4.1-6P-T1	BSUM-6.6-7P-T1	BSUM-6.6-9P-T1
CONTROLADOR	√	√	√	√	√	√	√	√	√	√	√	√	√	√	√	√	√	√	√	CTRL-CA/CC-2.2-T1	CTRL-CA/CC-1.5-T1	CTRL-CA/CC-3.0-T1	CTRL-CA/CC-4.0-T1	CTRL-CA/CC-5.5-T1	CTRL-CA/CC-7.5-T1	CTRL-CA/CC-11.0-T1	CTRL-CA/CC-13.0-T1	CTRL-CA/CC-15.0-T1										
MOTOR	√	√	√	√	√	√	√	√	√	√	√	√	√	√	√	√	√	√	√	MSUM4-1.5-T1	MSUM4-2.2-T1	MSUM4-3-T1	MSUM4-4-T1	MSUM4-5.5-T1	MSUM4-7.5-T1	MSUM4-11-T1	MSUM4-13-T1	MSUM4-15-T1										

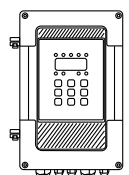

REFACCIONES SOPORTES PARA PANELES SOLARES

REFACCIÓN	RAIN ADIC2	RAIN BASE4	AURA-XN-ADIC2	AURA-XN-BASE4	RAIN-SPTE-L	RAIN-SPTE-VENT	RAIN-SPTE-AUR	CÓDIGO
RIEL SOPORTE	√	√	√	√				R-RAIN-RIELS
FIJADOR INTERMEDIO	√	√	√	√				R-RAIN-FIJINT
FIJADOR FINAL		√		√				R-RAIN-FIJFI
JUNTA RIEL SOPORTE	√	√	√	√				R-RAIN-JUNTAR
CLIP	√	√	√	√				R-RAIN-CLIP
PLACA PARA TIERRA	√	√	√	√				R-RAIN-PTIE
TERMINAL TIERRA	√	√	√	√				R-RAIN-TERMT
SOPORTE SUPERIOR TRASERO			√	√			√	R-RAIN-SSUP
SOPORTE INFERIOR			√	√			√	R-RAIN-SINF
SOPORTE L					√			R-RAIN-SL

REFACCIONES SERIE: BEYOND

REFACCIÓN	BEYOND2KM2/1	BEYOND3KM2/1	BEYOND5KM2/2	BEYOND6KM2/2	BEYOND8KM2/2	BEYOND10KM2/2	CÓDIGO
CONECTOR VCA 2/3	√	√					R-BEYOND-CVCA2/3
CONECTOR VCA 5/6			√	√			R-BEYOND-CVCA5/6
CONECTOR VDC HEMBRA	√	√	√	√			R-BEYOND-CCD-PLUH
					√	√	R-BEYOND-CCD-8/10H
CONECTOR VDC MACHO	√	√	√	√			R-BEYOND-CCD-MINM
					√	√	R-BEYOND-CCD-8/10M
DISPOSITIVO INYECCION ZERO	√	√	√	√	√	√	R-BEYOND-SENCT
TABLILLA DE CONEXION			√	√	√	√	R-BEYOND-TCONEX
BORNE DE CONEXION	√	√					R-BEYOND-BCONEX

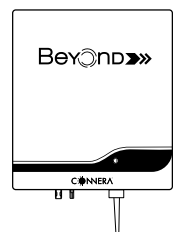
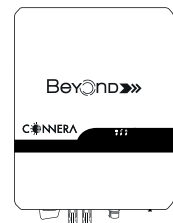

SERIE: BEYOND TRIFÁSICOS

REFACCIÓN	BEYOND30KT2/4	BEYOND60KT4/4	CÓDIGO
CONECTOR RS485	√	√	R-BEYOND-RS485
CONECTOR VDC HEMBRA	√	√	R-BEYOND-CCD-8/10H
CONECTOR VDC MACHO	√	√	R-BEYOND-CCD-8/10M
MODULO WIFI UNIVERSAL	√	√	R-BEYOND-WIFI
TABLILLA CONEXIÓN VCA BEYOND TRIFASICO	√	√	R-BEYOND-TCONEXION
TAPA DE CONEXIÓN VCA	√	√	R-BEYOND-TAPA-VCA

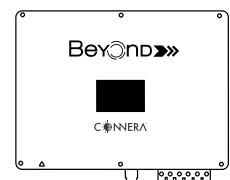

REFACCIÓN	FORTEPLUS 1KM2/1	FORTEPLUS 3KM2/2	FORTEPLUS 4KM2/2	FORTEPLUS 5KM2/2	CÓDIGO
RELAY	√	√	√	√	R-FPRELAY-1
	√	√	√	√	R-FPRELAY-2
	√	√	√	√	R-FPRELAY-3
SOPORTE PARED M2	√	√	√	√	R-FORTEPLUS-SPTM2
CONECTOR VCA S4 1F	√	√	√	√	R-FORTEPLUS-CMS4
CONECTOR VCA S5 1F	√	√	√	√	R-FORTEPLUS-CMS5
CONECTOR VCA S6 1F	√	√	√	√	R-FORTEPLUS-CMS6
TARJETA WIFI 1F	√	√	√	√	R-FORTEPLUSTWIFI
TARJETA DE CONTROL PCB	√				R-FORTEPLUSCTRB2.5
		√			R-FORTEPLUSCTRB3
			√		R-FORTEPLUSCTRB4
				√	R-FORTEPLUSCTRB5
DESCONECTADOR VCD	√	√			R-FORTEPLUSDESC1-3
			√	√	R-FORTEPLUSDESC4-5
CONECTOR CD	√	√	√	√	R-FORTEPLUSMC4INV
TRANSISTOR IGBT	√	√	√	√	R-FPIGBT-3

Nota: Revisar que el tipo de conector coincida con el que el cliente solicita. Ver despiece.

REFACCIÓN	FORTEPLUS 6KT2/2	FORTEPLUS 10KT2/2	CÓDIGO
DISPLAY 3F 6KW Y 10KW	√	√	R-FORTEPLUSDISP3F
TARJETA WIFI 3F	√	√	R-FORTEPLUSTWIFI3F
DESCONECTADOR VCD	√	√	R-FORTEPLUSDES6-10
CONECTOR CD	√	√	R-FORTEPLUSMC4INV
CONECTOR VCA 3F	√	√	R-FORTEPLUS-CVCAT

REFACCIONES F-DRIVE SOLAR/MP

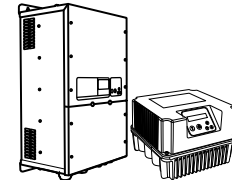

REFACCIÓN	F-DRIVE SOLAR 24100	F-DRIVE SOLAR 2438	F-DRIVE SOLAR 2448	F-DRIVE SOLAR 2465	F-DRIVE SOLAR 2485	F-DRIVE SOLAR212MP	F-DRIVE SOLAR245MP	F-DRIVE SOLAR248MP	F-DRIVE SOLAR245MP	F-DRIVE SOLAR2430MP	CÓDIGO	
TARJETA DE CONTROL			√			√					R-FDS-TC2448	
							√				R-FDS-TCTRL212	
								√			R-FDS-TCTRL415	
									√		R-FDS-TCTRL418	
									√		R-FDS-TCTRL425	
										√		R-FDS-TCTRL430
			√		√	√						R-FD TCTRL2485
						√				√	R-FDSMP-TCTRL	
TARJETA DE POTENCIA	√										R-FDS-TPOT100	
TARJETA DISPLAY						√	√	√	√		R-FDS-DISPLAY	
TAPA						√	√	√	√	√	R-FDS-TAPA	

PANEL SOLAR PARA AGUA DE PISCINA



REFACCIÓN	ECOHEAT-4M2	CÓDIGO
O-RING CONECTOR	√	R-ECO4M2-ORING
CONECTOR MACHO RHEMBRA 1 1/2"	√	R-ECO4M2-CMRH
CONECTOR HEMBRA RHEMBRA 1 1/2"	√	R-ECO4M2-CHRH
VÁLVULA DE 3 VÍAS DE 1-1 / 2 "	√	R-ECO4M2-VAL3VIAS
VÁLVULA CHECK 1-1 / 2"	√	R-ECO4M2-VALCNTRL
KIT MONTAJE PARA TECHO	√	ECOHEAT-KITMT
KIT DESVIADOR	√	ECOHEAT-KITD

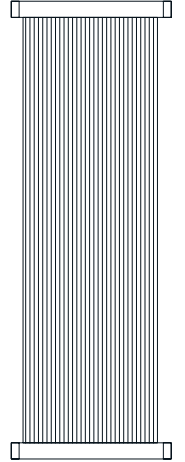



REFACCIONES MOTOBOMBA SUMERGIBLE



REFACCIÓN	THOR05/1127	CÓDIGO
CAPACITOR 40mF	√	E2068
BALERO SUP/INF	√	E1936
SELLO MEC. INFERIOR	√	E80-74567
SELLO MEC. SUPERIOR	√	E400/500
TAPA DIFUSOR	√	E10490
PIE	√	E10318
CABLE CONECTOR	√	E7144
BUJE	√	E126-102
DIFUSOR	√	E10489
IMPULSOR	√	E126-068

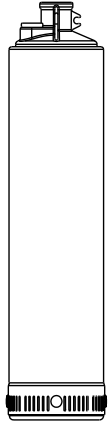

REFACCIONES MOTOBOMBA SUMERGIBLE

REFACCIÓN	KIN58-6/1115	CÓDIGO
VÁLVULA CHECK	√	R-KIN-VALV.CHECK
DESCARGA DE BOMBA DE 1.25"	√	R-KIN-DESCAR-1.25
KIT SELLADO	√	R-KIN-KITSELLADO
CAPACITOR DE 45MF	√	R-KIN-CAP45MF
SELLO MECÁNICO SUPERIOR	√	R-KIN-SM.SUP
BALERO SUPERIOR	√	R-KIN-BAL.SUP
CANDADO PARA SELLO MECÁNICO E IMPULSOR	√	R-KIN-CANDADO
DIFUSOR SUPERIOR	√	R-KIN-DIF.SU
IMPULSOR SUPERIOR	√	R-KIN-IMP.SUP
BALERO INFERIOR	√	R-KIN-BAL.INF
TAPA DE DIFUSOR	√	R-KIN-TAPA.DIFUSOR
ARANDELA DE ALTURA	√	R-KIN-ARANDELA
BUJES PARA LA FLECHA	√	R-KIN-KIT.BUJE
COLADOR	√	R-KIN-COLADOR
PIE DE BOMBA	√	R-KIN-PIE.BOM
SUCCIÓN DE LA BOMBA	√	R-KIN O-RING-P32
IMPULSOR INFERIOR	√	R-KIN-IMP.INF
DIFUSOR INFERIOR	√	R-KIN-DIF.INF
TAPA PORTA SELLO	√	R-KIN-TAP.PRT.SELL
SELLO MECÁNICO INFERIOR	√	R-KIN-SM.INF
CAMISA DE ACERO INOXIDABLE	√	R-KIN-CAMISA

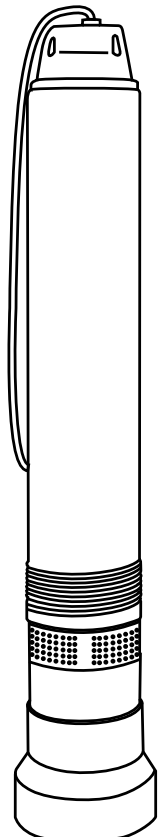

REFACCIÓN	SLIM8-5/1127	SLIM8-9/1127	SLIM8-13/1127	SLIM8-13/1230	SLIM8-17/1230	SLIM12-4/1127	SLIM12-7/1127	SLIM12-10/1127	SLIM12-10/1230	SLIM20-4/1127	SLIM20-6/1127	SLIM20-9/1230	SLIM25-7/1230	SLIM25-11/1230	SLIM30-7/1230	CÓDIGO
BOMBA	P															R-SLIM8-BM/5-8
		P														R-SLIM8-BM/9-8
			P	P												R-SLIM8-BM/13-8
					P											R-SLIM8-BM/17-8
						P										R-SLIM12-BM/4-10
							P									R-SLIM12-BM/7-10
								P	P							R-SLIM12-BM/10-10
										P						R-SLIM20-BM/4-16
											P					R-SLIM20-BM/6-16
												P				R-SLIM20-BM/9-16
													P			R-SLIM25-BM/7-22
														P		R-SLIM25-BM/11-22
															P	R-SLIM30-BM/7-27
CAJA DE CONTROL	P					P										CCTO-0.5-127
		P					P			P						CCTO-1-127
			P					P			P					CCTO-1.5-127
				P					P							CCTO-1.5-230
					P							P	P			CCTO-2-230
														P	P	CCTO-3-230

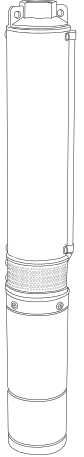

REFACCIONES

BOMBAS DOSIFICADORAS PERISTÁLTICAS

REFACCIÓN	E10FX BA1S	E10FX AB1S	E20FX CA1S	E20FX BA1S	E10FX HA1S	E20FX HA1S	E10VX AA1S	E10VX BA1S	E10VX HA1S	E20VX BA1S	E20VX CA1S	E20VX HA1S	CÓDIGO
CASQUILLO 1/4"	√	√	√	√	√	√	√	√	√	√	√	√	UCAK200
CONJUNTO DE RODILLOS BLANCOS	√	√	√	√			√	√		√	√		EC350
CONJUNTO DE RODILLOS NEGROS					√	√			√			√	EC351
CUBIERTA CUERPO BOMBA	√	√	√	√	√	√	√	√	√	√	√	√	EC355
FERRULAS 1/4"	√	√	√	√	√	√	√	√	√	√	√	√	MCAK200
KIT DE ENGRANES EC310	√	√			√		√	√	√				EC310
KIT DE ENGRANES EC320			√	√		√				√	√	√	EC320
MANGUERA SUC. Y DESC. 1/4" BCO.	√	√	√	√	√	√	√	√	√	√	√	√	AK4002W
CAJA DE ENG. Y CUB. DE CAB. AZUL	√	√	√	√	√	√	√	√	√	√	√	√	EC330
TUBO "A" SANTOPRENE		√					√						EC30A-2
TUBO "B" SANTOPRENE	√							√		√			EC30B-2
TUBO "C" SANTOPRENE			√								√		EC30C-2
TUBO "H" SANTOPRENE					√	√			√			√	EC30H-2
TUERCA CONEXIÓN MANGUERA 1/4"	√	√	√	√	√	√	√	√	√	√	√	√	UCAK100
VALVULA CHECK 1/4"					√	√			√			√	UCDBINJ
FILTRO DE SUC. CON PESA DE 1/4"	√	√	√	√	√	√	√	√	√	√	√	√	ST114
VAL. CHECK SANTOPRENE 1/4" 100PSI	√	√	√	√	√	√	√	√	√	√	√	√	MCDBINJ

STENNER PUMPS®

REFACCIONES BOMBAS DOSIFICADORAS PERISTÁLTICAS 45M

REFACCIÓN	45MFH1A2S	45MFH2A2S	45MFH2A2T	45MFH7A2S	45MFL1A2S	45MFL2A2S	45MFL2A2T	45MFL3A2S	45MFL4A2S	45MFL5A2S	45MFL5A2T	45MJH1A2S	45MJH2A2S	45MJH2A2T	45MJH7A2S	45MJL1A2S	45MJL2A2S	45MJL2A2T	45MJL3A2S	45MJL4A2S	45MJL5A2S	45MJL5A2T	CÓDIGO
ARAÑA P/ GUIA BOMBA PERIST. S/45,85,100 y 170	√	√	√	√	√	√	√	√	√	√	√	√	√	√	√	√	√	√	√	√	√	√	FC5K00D
BOTON DE INTERRUPTOR	√	√	√	√	√	√	√	√	√	√	√	√	√	√	√	√	√	√	√	√	√	√	MP6C000
CAB. #1-SANTOPRENO/IFERULAS 1/4" 25PSI	√				√							√				√							QP251-1
CAB. #2-SANTOPRENO/IFERULAS 1/4" 25PSI		√				√							√			√	√						QP252-2
CAB. #5-SANTOPRENO/IFERULAS 1/4" 25PSI					√	√	√	√	√	√	√					√	√	√	√	√	√	√	QP255-2
CAB. #7-SANTOP/IFERUJ. y GOMA VALV/INyec. 1/4" 100PSI	√	√	√	√								√	√	√	√								QP107-1
CAB. /IFERULAS y GOMA VALV/INyec. 1/4" (1 PK) 100PSI	√											√											QP101-1
CABEZAL CON FERULAS 1/4"											√											√	QP25T5-1
CÁMARA VARIABLE	√	√	√	√	√	√	√	√	√	√	√	√	√	√	√	√	√	√	√	√	√	√	UCFC5H0
CARCAZA PARA TUBO	√	√	√	√	√	√	√	√	√	√	√	√	√	√	√	√	√	√	√	√	√	√	QP400-1
CASQUILLO 1/4", 10 PZ	√	√	√	√	√	√	√	√	√	√	√	√	√	√	√	√	√	√	√	√	√	√	UCAK200
CONJ. DE RODILLOS BIDOSIFIC. QP	√	√	√	√	√	√	√	√	√	√	√	√	√	√	√	√	√	√	√	√	√	√	QP500-1
CONTR. CAUDAL / EJE CAUDAL AJUST.												√	√	√	√	√	√	√	√	√	√	√	FC5040D
CUBIERTA CABEZAL CON COJINETE	√	√	√	√	√	√	√	√	√	√	√	√	√	√	√	√	√	√	√	√	√	√	QP100-1
FERRULAS 1/4"	√	√	√	√	√	√	√	√	√	√	√	√	√	√	√	√	√	√	√	√	√	√	MCAK200
FILTRO DE SUC. CON PESA DE 1/4"	√	√	√	√	√	√	√	√	√	√	√	√	√	√	√	√	√	√	√	√	√	√	ST114
INDEX PIN P/BOMBA PERISTALTICA	√	√	√	√	√	√	√	√	√	√	√	√	√	√	√	√	√	√	√	√	√	√	FC5L002
INDEX PLATE P/BOMBA PERISTALTICA	√	√	√	√	√	√	√	√	√	√	√	√	√	√	√	√	√	√	√	√	√	√	UCFC5ID
INTERRUPTOR ON/OFF	√	√	√	√	√	√	√	√	√	√	√	√	√	√	√	√	√	√	√	√	√	√	PM6E000
JUEGO DE 5 TUBOS #5 VERSILON											√											√	MCTYG05
KIT ACC STENNER 100PSI-TUBO7-1/4 UNNEGRA,				√											√								HPACK7B
KIT CABEZAL BOMBA #5 (0-25PSI)										√											√		QP255K
KIT CABEZAL BOMBA #7 1/4", 26-100PSI				√											√								QP107K
KIT DE REP. / CONTROL DE CAUDAL	√	√	√	√	√	√	√	√	√	√	√	√	√	√	√	√	√	√	√	√	√	√	FSK100
KIT DE SER. P/ BOMBA STENNER #7				√											√								PSKH07
KIT DE SERV. P/ BOMBA STENNER #1	√											√											PSKH01
MANG. SUC./DESC. NEGRA 1/4" 6M	√	√	√	√	√	√	√	√	√	√	√	√	√	√	√	√	√	√	√	√	√	√	AK4002B
MOT.B.PERIS.CAUD.FUJO 45 115V 60HZ 26RPM	√	√	√	√	√	√	√	√	√	√	√												ME6041D
MOTOR DE BOMBA 115V 60HZ 26RPM												√	√	√	√	√	√	√	√	√	√	√	PM6041D
PASADOR DE ÍNDICE	√	√	√	√	√	√	√	√	√	√	√	√	√	√	√	√	√	√	√	√	√	√	UCFC5AY
PLACA DE INTERRUPTOR ON/OFF	√	√	√	√	√	√	√	√	√	√	√	√	√	√	√	√	√	√	√	√	√	√	MP6D000
TORNILLOS PARA CUBIERTA	√	√	√	√	√	√	√	√	√	√	√	√	√	√	√	√	√	√	√	√	√	√	UCCPS0B
TUBO N.1 SANTOPRENE DOSIF.0-100PSI	√				√							√				√							UCCP201
TUBO N.2 SANTOPRENE DOSIF.0-100PSI		√	√			√	√						√	√				√	√				UCCP202
TUBO N.2 SANTOPRENE PERISTAL 0-25PSI					√	√		√	√							√	√		√	√	√	√	MCCP202
TUBO N.2 TYGOTANE DOSIF.0-100PSI			√				√							√				√					UCTYG02
TUBO N.3 SANTOPRENE DOSIF.0-25PSI								√										√					UCCP203
TUBO N.4 SANTOPRENE DOSIF.0-25PSI									√										√				UCCP204
TUBO N.5 SANTOPRENE DOSIF.0-25PSI										√										√			UCCP205
TUBO N.5 TYGOTANE P/B.PERISTALT.0-25PSI											√										√		UCTYG05
TUBO N.7 SANTOPRENE DOSIF.26-100PSI				√											√								UCCP207
TUERCAS DE CONEXIÓN 1/4"	√	√	√	√	√	√	√	√	√	√	√	√	√	√	√	√	√	√	√	√	√	√	MCAK100
VÁLV. CHECK SANTOPRENE 1/4" 100PSI	√	√	√	√	√	√	√	√	√	√	√	√	√	√	√	√	√	√	√	√	√	√	MCDBINJ
VÁLVULA CHECK 1/4"	√	√	√	√								√	√	√	√	√	√	√	√	√	√	√	UCDBINJ
VENTILADOR BOMBA STENNER	√	√	√	√	√	√	√	√	√	√	√	√	√	√	√	√	√	√	√	√	√	√	PM6F000



STENNER PUMPS®

REFACCIONES BOMBAS DOSIFICADORAS PERISTÁLTICAS 85M

REFACCIÓN	85MF1A2S	85MF2A2S	85MF2A2T	85MF7A2S	85MFL1A2S	85MFL2A2S	85MFL2A2T	85MFL3A2S	85MFL4A2S	85MFL5A2S	85MFL5A2T	85MJ1H1A2S	85MJ1H2A2S	85MJ1H2A2T	85MJ1H7A2S	85MJ11A2S	85MJ12A2S	85MJ12A2T	85MJ13A2S	85MJ14A2S	85MJ15A2S	85MJ15A2T	CÓDIGO
ARAÑA PARA GUIA DE BOMBA	√	√	√	√	√	√	√	√	√	√	√	√	√	√	√	√	√	√	√	√	√	√	FC5K00D
BOTON DE INTERRUPTOR	√	√	√	√	√	√	√	√	√	√	√	√	√	√	√	√	√	√	√	√	√	√	MP6C000
CAB. QP COMP. #1 - SANTOP. /FERU. 1/4" 25PSI	√				√							√				√							QP251-1
CAB. QP COMP. #2 - SANTOP. /FERU. 1/4" 25PSI		√				√							√				√						QP252-2
CAB. QP COMP. #5 - SANTOP. /FERU. 1/4" 25PSI					√	√	√	√	√	√	√					√	√	√	√	√	√	√	QP255-2
CAB.QP COMP.#1-SANTOP./FERU./GOMA/VALV/INYEC.1/4"100PSI	√											√											QP101-1
CAB.QP COMP.#7-SANTOP./FERU./GOMA/VALV/INYEC.1/4"100PSI	√	√	√	√								√	√	√	√								QP107-1
CAB. QP #5 TUBO VERSILON /FERULAS 1/4"											√											√	QP25T5-1
CÁMARA VARIABLE	√	√	√	√	√	√	√	√	√	√	√	√	√	√	√	√	√	√	√	√	√	√	UCFC5H0
CARCAZA PARA TUBO	√	√	√	√	√	√	√	√	√	√	√	√	√	√	√	√	√	√	√	√	√	√	QP400-1
CASQUILLO 1/4"	√	√	√	√	√	√	√	√	√	√	√	√	√	√	√	√	√	√	√	√	√	√	UCAK200
CONJ. DE ROD. BOM. DOSIFIC. QP	√	√	√	√	√	√	√	√	√	√	√	√	√	√	√	√	√	√	√	√	√	√	QP500-1
CONTRI CAUD. /EJE CAUD. AJUST.- DOSIFIC.												√	√	√	√	√	√	√	√	√	√	√	FC5040D
CUBIERTA CAB. QP CON COJINETE	√	√	√	√	√	√	√	√	√	√	√	√	√	√	√	√	√	√	√	√	√	√	QP1001
FERRULAS 1/4"	√	√	√	√	√	√	√	√	√	√	√	√	√	√	√	√	√	√	√	√	√	√	MCAK200
FILTRO DE SUC. CON PESA DE 1/4"	√	√	√	√	√	√	√	√	√	√	√	√	√	√	√	√	√	√	√	√	√	√	ST114
INDEX PIN P/B.PERISTALTICA	√	√	√	√	√	√	√	√	√	√	√	√	√	√	√	√	√	√	√	√	√	√	FC5L002
INDEX PLATE POS#10 P/B.PERISTAL.	√	√	√	√	√	√	√	√	√	√	√	√	√	√	√	√	√	√	√	√	√	√	UCFC5ID
INTERRUPTOR ON/OFF	√	√	√	√	√	√	√	√	√	√	√	√	√	√	√	√	√	√	√	√	√	√	PM6E000
JUEGO DE 5 TUBOS #5 VERSILON											√											√	MCTYG05
KIT / REP. CONTROLADOR CAUDAL	√	√	√	√	√	√	√	√	√	√	√	√	√	√	√	√	√	√	√	√	√	√	FSK100
KIT ACC STENNER 100PSI-TUBO7-1/4 UVNEGRA				√											√								HPACK7B
KIT DE CAB. DE BOM #7 QUICK PRO1/4"				√											√								QP107K
KIT DE CABEZAL DE BOM. (0-25PSI)										√												√	QP255K
KIT DE ENGRANES CAUDAL AJUST.												√	√	√	√	√	√	√	√	√	√	√	GSK85FA
KIT DE ENGRANES CAUDAL FIJO	√	√	√	√	√	√	√	√	√	√	√												GSK85F
KIT DE SERV. P/ BOM STENNER #1	√											√											PSKH01
KIT DE SERV. P/ BOM STENNER #7				√											√								PSKH07
MANGUERA SUC./DESC. NEGRA 1/4" 6M	√	√	√	√	√	√	√	√	√	√	√	√	√	√	√	√	√	√	√	√	√	√	AK4002B
MOTOR / BOM CAUD. FIJO 115V 60HZ 44RPM	√	√	√	√	√	√	√	√	√	√	√												ME6081D
MOTOR BOM AJUST. 115V 60HZ 44RPM												√	√	√	√	√	√	√	√	√	√	√	PM6081D
PASADOR DE ÍNDICE	√	√	√	√	√	√	√	√	√	√	√	√	√	√	√	√	√	√	√	√	√	√	UCFC5AY
PLACA DE INTERRUPTOR ON/OFF	√	√	√	√	√	√	√	√	√	√	√	√	√	√	√	√	√	√	√	√	√	√	MP6D000
TORNILLOS PARA CUBIERTA	√	√	√	√	√	√	√	√	√	√	√	√	√	√	√	√	√	√	√	√	√	√	UCCPS0B
TUBO N.1 SANTOPRENE DOSIF.0-100PSI	√				√							√				√							UCCP201
TUBO N.2 SANTOPRENE DOSIF.0-100PSI		√	√			√	√						√	√									UCCP202
TUBO N.2 SANTOPRENE PERISTAL 0-25PSI					√	√		√	√	√						√	√		√	√	√		MCCP202
TUBO N.2 TYGOTANE DOSIF.0-100PSI			√				√							√				√					UCTYG02
TUBO N.3 SANTOPRENE DOSIF.0-25PSI								√											√				UCCP203
TUBO N.4 SANTOPRENE DOSIF.0-25PSI									√											√			UCCP204
TUBO N.5 SANTOPRENE DOSIF.0-25PSI										√											√		UCCP205
TUBO N.5 TYGOTANE P/B.PERISTAL.0-25PSI											√											√	UCTYG05
TUBO N.7 SANTOPRENE DOSIF.26-100PSI				√											√								UCCP207
TUERCAS DE CONEX. 1/4" STENNER	√	√	√	√	√	√	√	√	√	√	√	√	√	√	√	√	√	√	√	√	√	√	MCAK100
VÁLV. CHECK 1/4" P/BOM. PERISTAL	√	√	√	√								√	√	√	√								UCDBINJ
VÁLV. CHECK SANTOPRENE 1/4" 100PSI	√	√	√	√	√	√	√	√	√	√	√	√	√	√	√	√	√	√	√	√	√	√	MCDBINJ
VENTILADOR	√	√	√	√	√	√	√	√	√	√	√	√	√	√	√	√	√	√	√	√	√	√	PM6F000

STENNER PUMPS®

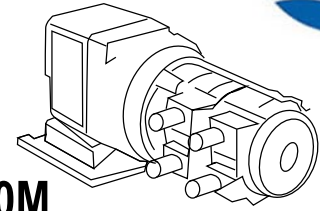

REFACCIONES

BOMBAS DOSIFICADORAS PERISTÁLTICAS 100M

REFACCIÓN	100FH1A2S	100FH2A2S	100FH2A2T	100FL1A2S	100FL2A2S	100FL2A2T	100FL3A2S	100FL4A2S	100FL5A2S	100FL5A2T	100JH1A2S	100JH2A2S	100JH2A2T	100JL1A2S	100JL2A2S	100JL2A2T	100JL3A2S	100JL4A2S	100JL5A2S	100JL5A2T	CÓDIGO
ARAÑA PARA GUIA DE BOMBA	√	√	√	√	√	√	√	√	√	√	√	√	√	√	√	√	√	√	√	√	FC5K00D
BOTÓN DE INTERRUPTOR	√	√	√	√	√	√	√	√	√	√	√	√	√	√	√	√	√	√	√	√	MP6C000
CAB. QP COMP. #1 - SANTOPRE. FER. y GOMA VALVINYEC 1/4" 100PSI	√										√										QP101-1
CAB. INTERNO SANTOPRENE #5 CON FERULAS 1/4" 25PSI									√											√	QPA255-1
CAB. QP #5 TUBO VERSILON CON FERULAS 1/4"										√										√	QP25T5-1
CAB. QP COMP. #1 - SANTOPRENO /FERULAS 1/4" 25PSI	√			√							√			√							QP251-1
CAB. QP COMP. #2 - SANTOPRENO /FERULAS 1/4" 25PSI		√			√							√			√						QP252-2
CÁMARA VARIABLE	√	√	√	√	√	√	√	√	√	√	√	√	√	√	√	√	√	√	√	√	UCFC5H0
CASQUILLO 1/4"	√	√	√	√	√	√	√	√	√	√	√	√	√	√	√	√	√	√	√	√	UCAK200
CONJ. DE RODILLOS BOMBA DOSIFIC. QP	√	√	√	√	√	√	√	√	√	√	√	√	√	√	√	√	√	√	√	√	QP500-1
FERRULAS 1/4"	√	√	√	√	√	√	√	√	√	√	√	√	√	√	√	√	√	√	√	√	MCAK200
FILTRO DE SUCCIÓN CON PESA DE 1/4"	√	√	√	√	√	√	√	√	√	√	√	√	√	√	√	√	√	√	√	√	ST114
INDEX PIN P/B.PERISTALTICA	√	√	√	√	√	√	√	√	√	√	√	√	√	√	√	√	√	√	√	√	FC5L002
INDEX PLATE POS#10 P/B.PERISTALTICA	√	√	√	√	√	√	√	√	√	√	√	√	√	√	√	√	√	√	√	√	UCFC5ID
INTERRUPTOR ON/OFF	√	√	√	√	√	√	√	√	√	√	√	√	√	√	√	√	√	√	√	√	PM6E000
JUEGO DE 5 TUBOS #5 VERSILON										√										√	MCTYG05
KIT DE CABEZAL DE BOMBA (0-25PSI)									√											√	QP255K
KIT DE ENGRANES CAUDAL AJUSTABLE											√	√	√	√	√	√	√	√	√	√	GSK85FA
KIT DE ENGRANES CAUDAL FIJO	√	√	√	√	√	√	√	√	√	√											GSK85F
KIT DE REP. DEL CONTROLADOR DE CAUDAL	√	√	√	√	√	√	√	√	√	√	√	√	√	√	√	√	√	√	√	√	FSK100
KIT DE SERVICIO P/ BOMBA STENNER #1	√										√										PSKH01
MANG. SUC./DESCARGA NEGRA 1/4" 6M	√	√	√	√	√	√	√	√	√	√	√	√	√	√	√	√	√	√	√	√	AK4002B
MOTOR BOMBA AJUST. 115V 60HZ 44RPM											√	√	√	√	√	√	√	√	√	√	PM6081D
PASADOR DE ÍNDICE	√	√	√	√	√	√	√	√	√	√	√	√	√	√	√	√	√	√	√	√	UCFC5AY
PLACA DE INTERRUPTOR ON/OFF	√	√	√	√	√	√	√	√	√	√	√	√	√	√	√	√	√	√	√	√	MP6D000
TUBO N.1 SANTOPRENE DOSIF.0-100PSI	√			√							√			√							UCCP201
TUBO N.2 SANTOPRENE DOSIF.0-100PSI		√	√		√	√						√	√		√	√					UCCP202
TUBO N.2 SANTOPRENE PERISTAL 0-25PSI		√	√		√	√						√	√		√	√					MCCP202
TUBO N.2 TYGOTANE DOSIF.0-100PSI			√			√							√		√						UCTYG02
TUBO N.3 SANTOPRENE DOSIF.0-25PSI							√										√				UCCP203
TUBO N.4 SANTOPRENE DOSIF.0-25PSI								√										√			UCCP204
TUBO N.5 SANTOPRENE DOSIF.0-25PSI									√											√	UCCP205
TUBO N.5 TYGOTANE P/B.PERISTALT.0-25PSI										√										√	UCTYG05
TUERCAS DE CONEXIÓN 1/4" STENNER	√	√	√	√	√	√	√	√	√	√	√	√	√	√	√	√	√	√	√	√	MCAK100
VÁLVULA CHECK 1/4" P/BOMBA PERISTAL	√	√	√								√	√	√								UCDBINJ
VÁLV. CHECK SANTOPRENE 1/4" 100PSI	√	√	√	√	√	√	√	√	√	√	√	√	√	√	√	√	√	√	√	√	MCDBINJ
VENTILADOR	√	√	√	√	√	√	√	√	√	√	√	√	√	√	√	√	√	√	√	√	PM6F000

REFACCIONES

BOMBAS DOSIFICADORAS PERISTÁLTICAS 170M

REFACCIÓN	170FH1A2S	170FH2A2S	170FH2AZT	170FL1A2S	170FL2A2S	170FL2AZT	170FL3A2S	170FL4A2S	170FL5A2S	170FL5AZT	170JH1A2S	170JH2A2S	170JH2AZT	170JL1A2S	170JL2A2S	170JL2AZT	170JL3A2S	170JL4A2S	170JL5A2S	170JL5AZT	CÓDIGO
ARAÑA PARA GUIA DE BOMBA	✓	✓	✓	✓	✓	✓	✓	✓	✓	✓	✓	✓	✓	✓	✓	✓	✓	✓	✓	✓	FC5K00D
BOTON DE INTERRUPTOR	✓	✓	✓	✓	✓	✓	✓	✓	✓	✓	✓	✓	✓	✓	✓	✓	✓	✓	✓	✓	MP6C000
CAB. QP COMP. #1 - SANTOPRE. /FERU. 1/4" 25PSI	✓			✓							✓			✓							QP251-1
CAB. QP COMP. #1-SANTOP. FERU. /GOMA VALV INYEC.1/4"100PSI	✓										✓										QP101-1
CAB. QP COMP. #2 - SANTOPRE. /FER. 1/4" 25PSI		✓			✓							✓			✓						QP252-2
CABEZAL INT. SANTOPRENE #5 FERULAS 1/4" 25PSI									✓										✓		QPA255-1
CABEZAL QP #5 TUBO VERSILON FERULAS 1/4"										✓										✓	QP25T5-1
CÁMARA VARIABLE	✓	✓	✓	✓	✓	✓	✓	✓	✓	✓	✓	✓	✓	✓	✓	✓	✓	✓	✓	✓	UCFC5H0
CASQUILLO 1/4"	✓	✓	✓	✓	✓	✓	✓	✓	✓	✓	✓	✓	✓	✓	✓	✓	✓	✓	✓	✓	UCAK200
CONJ. DE RODILLOS BOMBA DOSIFIC. QP	✓	✓	✓	✓	✓	✓	✓	✓	✓	✓	✓	✓	✓	✓	✓	✓	✓	✓	✓	✓	QP500-1
FERRULAS 1/4"	✓	✓	✓	✓	✓	✓	✓	✓	✓	✓	✓	✓	✓	✓	✓	✓	✓	✓	✓	✓	MCAK200
FILTRO DE SUCCION CON PESA DE 1/4"	✓	✓	✓	✓	✓	✓	✓	✓	✓	✓	✓	✓	✓	✓	✓	✓	✓	✓	✓	✓	ST114
INDEX PIN P/B.PERISTALTICA	✓	✓	✓	✓	✓	✓	✓	✓	✓	✓	✓	✓	✓	✓	✓	✓	✓	✓	✓	✓	FC5L002
INDEX PLATE POS#10 P/B.PERISTALTICA	✓	✓	✓	✓	✓	✓	✓	✓	✓	✓	✓	✓	✓	✓	✓	✓	✓	✓	✓	✓	UCFC5ID
INTERRUPTOR ON/OFF	✓	✓	✓	✓	✓	✓	✓	✓	✓	✓	✓	✓	✓	✓	✓	✓	✓	✓	✓	✓	PM6E000
JUEGO DE 5 TUBOS #5 VERSILON										✓										✓	MCTYG05
KIT DE CABEZAL DE BOMBA (0-25PSI)									✓											✓	QP255K
KIT DE REP. DEL CONTROLDOR CAUDAL	✓	✓	✓	✓	✓	✓	✓	✓	✓	✓	✓	✓	✓	✓	✓	✓	✓	✓	✓	✓	FSK100
KIT DE SERVICIO P/ BOMBA STENNER #1	✓										✓										PSKH01
MANGUERA SUC./DESC. NEGRA 1/4" 6M	✓	✓	✓	✓	✓	✓	✓	✓	✓	✓	✓	✓	✓	✓	✓	✓	✓	✓	✓	✓	AK4002B
MOTOR / BOM. AJUSTABLE 115V 60HZ 26RPM											✓	✓	✓	✓	✓	✓	✓	✓	✓	✓	PM6041D
PASADOR DE ÍNDICE	✓	✓	✓	✓	✓	✓	✓	✓	✓	✓	✓	✓	✓	✓	✓	✓	✓	✓	✓	✓	UCFC5AY
PLACA DE INTERRUPTOR ON/OFF	✓	✓	✓	✓	✓	✓	✓	✓	✓	✓	✓	✓	✓	✓	✓	✓	✓	✓	✓	✓	MP6D000
TUBO N.1 SANTOPRENE DOSIF.0-100PSI	✓			✓							✓			✓							UCCP201
TUBO N.2 SANTOPRENE DOSIF.0-100PSI		✓	✓		✓	✓						✓	✓		✓	✓					UCCP202
TUBO N.2 SANTOPRENE PERISTAL 0-25PSI					✓	✓						✓	✓		✓	✓					MCCP202
TUBO N.2 TYGOTANE DOSIF.0-100PSI			✓			✓							✓			✓					UCTYG02
TUBO N.3 SANTOPRENE DOSIF.0-25PSI							✓										✓				UCCP203
TUBO N.4 SANTOPRENE DOSIF.0-25PSI								✓										✓			UCCP204
TUBO N.5 SANTOPRENE DOSIF.0-25PSI									✓										✓		UCCP205
TUBO N.5 TYGOTANE P/B.PERISTALT.0-25PSI										✓										✓	UCTYG05
TUERCAS DE CONEXIÓN 1/4" STENNER	✓	✓	✓	✓	✓	✓	✓	✓	✓	✓	✓	✓	✓	✓	✓	✓	✓	✓	✓	✓	MCAK100
VÁLVULA CHECK 1/4" P/BOMBA PERISTAL	✓	✓	✓								✓	✓	✓								UCDBINJ
VÁLVULA CHECK SANTOPRENE 1/4" 100PSI	✓	✓	✓	✓	✓	✓	✓	✓	✓	✓	✓	✓	✓	✓	✓	✓	✓	✓	✓	✓	MCDBINJ
VENTILADOR	✓	✓	✓	✓	✓	✓	✓	✓	✓	✓	✓	✓	✓	✓	✓	✓	✓	✓	✓	✓	PM6F000

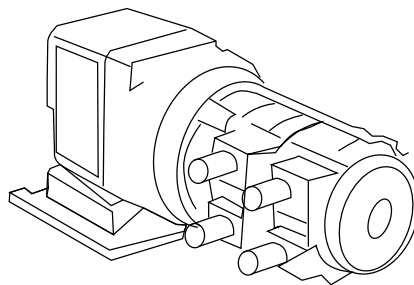

REFACCIONES

BOMBAS DOSIFICADORAS PERISTÁLTICAS

REFACCIÓN	E10FXBA1S	E10FXAB1S	E20FXCA1S	E20FXBA1S	E10FXHA1S	E20FXHA1S	E10VXAA1S	E10VXBA1S	E10VXHA1S	E20VXBA1S	E20VXCA1S	E20VXHA1S	E20PHH71S	E20PHHB1S	E10T2CB1S	E10T2C71S	E20T4H71S	E20T4HB1S	S3007AA101N	S3007BA101N	S4FTXAA3011	S4FTXBA3011	CÓDIGO	
CAJA DE ENG. Y CUB. DE CAB. AZUL	√	√	√	√	√	√	√	√	√	√	√	√											EC330	
CASQUILLO 1/4"	√	√	√	√	√	√	√	√	√	√	√	√											UCAK200	
CONJUNTO DE RODILLOS BLANCOS	√	√	√	√			√	√		√	√		√	√	√	√	√	√	√	√			EC350	
CONJUNTO DE RODILLOS NEGROS					√	√			√			√											EC351	
CUBIERTA CUERPO BOMBA	√	√	√	√	√	√	√	√	√	√	√	√											EC355	
FERRULAS 1/4"	√	√	√	√	√	√	√	√	√	√	√	√											MCAK200	
FILTRO DE SUC. CON PESA DE 1/4"	√	√	√	√	√	√	√	√	√	√	√	√											ST114	
KIT DE ENGRANES EC310	√	√			√		√	√	√														EC310	
KIT DE ENGRANES EC320			√	√		√				√	√	√											EC320	
MANGUERA SUC. Y DESC. 1/4" BCO.	√	√	√	√	√	√	√	√	√	√	√	√	√	√	√	√	√	√	√	√	√	√	AK4002W	
TUBO "A" SANTOPRENE		√					√																EC30A-2	
TUBO "B" SANTOPRENE	√							√		√			√	√			√	√	√	√			EC30B-2	
TUBO "C" SANTOPRENE			√								√		√	√			√	√					EC30C-2	
TUBO "H" SANTOPRENE					√	√			√			√	√	√	√	√	√	√	√	√			EC30H-2	
TUBO 0-100 PSI 2 PZS																					√	√	UCCP201	
TUBO 0-25 PSI 2 PZS																						√	√	UCCP202
																						√	√	UCCP203
																						√	√	UCCP205
																						√	√	MCCP202
TUBO 0-25 PSI 5 PZS																						√	√	MCCP202
TUBO 25-100 PSI 2 PZS																						√	√	UCCP207
TUBO 7 5 PACK																						√	√	MCCP207
TUBO C 5 PACK													√	√			√	√					EC30C-5	
TUBO H 5 PACK													√	√	√	√	√	√	√	√			EC30H-5	
TUERCA CONEXIÓN MANGUERA 1/4"	√	√	√	√	√	√	√	√	√	√	√	√											UCAK100	
VAL. CHECK SANTOPRENE 1/4" 100PSI	√	√	√	√	√	√	√	√	√	√	√	√	√	√	√	√	√	√	√	√	√	√	MCDBINJ	
VALVULA CHECK 1/4"					√	√			√			√	√	√	√	√	√	√	√	√	√	√	UCDBINJ	

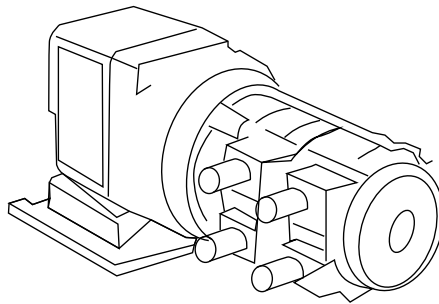



MÁXIMO CONFORT PARA TU HOGAR

REFACCIONES

CALENTADORES DE AGUA DE PASO

SERIES ESTÁNDAR Y SEMI-PROFESIONAL

REFACCIÓN	KAS-6N	KAS-6P	KAS-8P	KAS-8N	KAS-10N	KAS-10P	KAS-12N-TF	KAS-12P-TF	CÓDIGO
SENSOR DE TEMPERATURA KAS 6	√	√							R-KAS6-SEN-TEMP
TARJETA DE CONTROL PCB KAS 6	√	√							R-KAS6-T-CTRL-PCB
ELECTROVÁLVULA1 CERCA DE ENTRADA GASKAS6	√	√							R-KAS6-ELECTROVAL1
INTERCAMBIADOR DE CALOR KAS 6	√	√							R-KAS6-INTERCA-CAL
TERMOSTATO DE 75°C KAS 6	√	√							R-KAS6-TERMOSTATO
MICRO SWITCH KAS 6	√	√							R-KAS6-MICROSWITCH
ELECTROVÁLVULA2 CERCA DEL QUEMADOR KAS6	√	√							R-KAS6-ELECTROVAL2
COLECTOR VÁLVULAS AGUA-GAS KAS 6 NATURAL	√								R-KAS6N-COLECT-AG
COLECTOR VÁLVULAS AGUA-GAS KAS 6 PROPANO		√							R-KAS6P-COLECT-AG
INTERCAMBIADOR DE CALOR KAS 8			√	√					R-KAS8-INTERCA-CAL
TERMOSTATO DE 75°C KAS 8			√	√					R-KAS8-TERMOSTATO
COLECTOR VÁLVULAS AGUA-GAS KAS 8 NATURAL			√						R-KAS8N-COLECT-AG
COLECTOR VÁLVULAS AGUA-GAS KAS 8 PROPANO				√					R-KAS8P-COLECT-AG
COLECTOR VÁLVULAS AGUA-GAS KAS10 NATURAL					√				R-KAS10N-COLECT-AG
COLECTOR VÁLVULAS AGUA-GAS KAS10 PROPANO						√			R-KAS10P-COLECT-AG
DISPLAY KAS 6, KAS 8 Y KAS 10	√	√	√	√	√	√			R-KAS-DISPLAY
INTERRUPTOR ENCENDIDO KAS6, KAS8 Y KAS10	√	√	√	√	√	√			R-KAS-INTERRUPTOR
CAJA PORTA BATERÍAS KAS 6, KAS 8, KAS 10	√	√	√	√	√	√			R-KAS-CAJA-BATERIA
SENSOR DE TEMPERATURA KAS 8 Y KAS 10			√	√	√	√			R-KAS-SEN-TEMP
TARJETA DE CONTROL PCB KAS 8 Y KAS 10			√	√	√	√			R-KAS-T-CTRL-PCB
MICRO SWITCH KAS 8 Y KAS 10			√	√	√	√			R-KAS-MICROSWITCH
MEMBRANA KAS 8 Y KAS 10			√	√	√	√			R-KAS-MEMBRANA
DISCO PLÁSTICO MEMBRANA KAS 8 Y KAS 10			√	√	√	√			R-KAS-DISCO-MEMBRA
TORNILLO P. VÁLVULA DE AGUA (KAS8)(KAS10)			√	√	√	√			R-KAS-TORNVALV
ELECTROVÁLVULA KAS 8 Y KAS 10			√	√	√	√			R-KAS-ELECTROVALV
INTERCAMBIADOR DE CALOR KAS 10					√	√			R-KAS10-INTERC-CAL
TERMOSTATO DE 85°C KAS 10					√	√			R-KAS10-TERMOSTATO
DISPLAY DE CONTROL KAS 12							√	√	R-KAS12-DISPLAY
TERMOSTATO DE 80°C KAS 12							√	√	R-KAS12-TERMOSTATO
INTERRUPTOR DE PRESIÓN DE AIRE KAS 12							√	√	R-KAS12-INT-P-AIRE
TARJETA DE CONTROL PCB KAS 12							√	√	R-KAS12-T-CTRL-PCB
VENTILADOR KAS 12							√	√	R-KAS12-VENTILADOR
SENSOR DE TEMPERATURA KAS 12							√	√	R-KAS12-SEN-TEMP
INTERCAMBIADOR DE CALOR KAS 12							√	√	R-KAS12-INTERC-CAL
VÁLVULA PROPORCIONAL KAS 12							√	√	R-KAS12-VALV-PROP
VÁLVULA DE ADMISIÓN DE AGUA KAS 12							√	√	R-KAS12-VA-AD-AGUA
CABLE DE ALIMENTACIÓN KAS12							√	√	R-KAS12-CABLE-ALIM
ELECTROVÁLVULA KAS 12							√	√	R-KAS12-ELECTROVAL
EMPAQUE PAPEL KAS 12							√	√	R-KAS12-EMP-PAPEL



MÁXIMO CONFORT PARA TU HOGAR

REFACCIONES CALENTADORES DE AGUA DE PASO

SERIE PROFESIONAL

REFACCIÓN	KASPRO -16N	KASPRO -16P	CÓDIGO
TAPA FRONTAL KASPRO-16	√	√	R-KASP16-TPA.FRONT
INTERCAMBIADOR DE CALOR KASPRO-16	√	√	R-KASP16-INT.CAL
INTERRUPTOR DE SOBRE TEMPERATURA	√	√	R-KASP16-INT.S.TEM
FUSIBLE DE TEMPERATURA	√	√	R-KASP16-FUS.TEMP
CONJUNTO DE CÁMARA DE QUEMADOR (LPG/NG)	√	√	R-KASP16-CAM.QU.NP
CONJUNTO DE TUBERIA DE GAS (KASPRO-16N)	√		R-KAP16-C.TUB.GA.N
CONJUNTO DE TUBERIA DE GAS (KASPRO-16P)		√	R-KAP16-C.TUB.GA.P
CONJUNTO COLECTOR (KASPRO-16N)	√		R-KASP16-CNJ.COL.N
CONJUNTO COLECTOR (KASPRO-16P)		√	R-KASP16-CNJ.COL.P
ORING (P16) SENSOR DE FLUJO DE AGUA	√	√	R-KASP16-ORING-P16
ELECTRODO DE IGNICIÓN	√	√	R-KASP16-ELEC.IGNI
SENSOR DE OXIGENO	√	√	R-KASP16-SENS.OXIG
SISTEMA DE IGNICIÓN	√	√	R-KASP16-IGNICION
CONTROL TEMPERATURA PCB KASPRO-16	√	√	R-KASP16-CTRL.TEMP
ORING (P26) VÁLVULA DE GAS PROPORCIONAL	√	√	R-KASP16-ORING-P26
ORING (P18) VÁLVULA DE GAS PROPORCIONAL	√	√	R-KASP16-ORING-P18
VÁLVULA PROPORCIONAL DE GAS (GN-GLP)	√	√	R-KASP16-VA.PR.GAS
ORING (P24) CONECTOR DE ENTRADA DE GAS	√	√	R-KASP16-ORING-P24
CONECTOR DE ENTRADA DE GAS	√	√	R-KAP16-CNT.ENT.GA
ORING (P12.5) SALIDA DE AGUA CALIENTE	√	√	R-KAP16-ORIN-P12.5
TERMISTOR	√	√	R-KASP16-TERMISTOR
ORING (P4) PARA TERMISTOR	√	√	R-KASP16-ORING-P4
SENSOR DE FLUJO DE AGUA	√	√	R-KASP16-SENS.AGUA
CABLEADO DE CONEXIÓN	√	√	R-KAP16-CBLAD.CONE
TRANSFORMADOR	√	√	R-KASP16-TRANSF
VÁLVULA CHECK	√	√	R-KASP16-VALV.CHEC
MOTOR VENTILADOR	√	√	R-KASP16-MOT.VENTI
TARJETA DE CONTROL PCB	√	√	R-KASP16-T.CONT.PCB
CABLE DE ALIMENTACIÓN KASPRO-16	√	√	R-KASP16-CBL.ALIM
FILTRO PARA AGUA	√	√	R-KASP16-FILT.AGUA
VÁLVULA DE ALIVIO	√	√	R-KASP16-VALV.ALIV

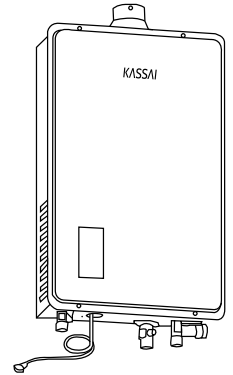

REFACCIÓN	CÓDIGO
Ensamble colector con válvula para gas propano	R-TKG-EK429
Ensamble colector con válvula para gas natural	R-TKG-EK421
Motor del ventilador	R-TKG-EX02E
Empaque soporte de la varilla	R-TKG-EKK2W
Varilla de flama	R-TKG-EX00R
Varilla del encendedor	R-TKG-EX00S
Soporte de la varilla	R-TKG-EX00U
Placa de encendido	R-TKG-EKK1B
Ensamble intercambiador de calor exterior	R-TKG-EK426
Valvula para ajustar flujo/sensor de flujo	R-TKG-EK427
Fusible de corte por sobrecalentamiento	R-TKG-EK333
Computadora para TKG-25	R-TKG-EK420
Ensamble colector con válvula para gas natural	R-TKG-EK555
Empaque soporte de la varilla	R-TKG-EK559
Varilla de flama con funcion AFR	R-TKG-EK560
Varilla del encendedor	R-TKG-EK561
Soporte de la varilla	R-TKG-EK562
Tapa de la varilla	R-TKG-EK462
Caja sobrecarga	R-TKG-EK436
Ensamble intercambiador de calor para TKGU-30 interior	R-TKG-EK605
Ensamble intercambiador de calor para TKGU-30 exterior	R-TKG-EK606
Ensamble intercambiador de calor para TKGU-38 interior	R-TKG-EK607
Ensamble intercambiador de calor para TKGU-38 exterior	R-TKG-EK608
Fusible de corte por sobrecalentamiento	R-TKG-EX02A
Computadora para TKGU-30	R-TKG-EK612
Computadora para TKGU-38	R-TKG-EK613
Ensamble colector con válvula para gas propano	R-TKG-EK181
Ensamble colector con válvula para gas natural	R-TKG-EK182
Motor del ventilador interior	R-TKG-EK109
Motor del ventilador exterior	R-TKG-EKK25
Varilla de flama	R-TKG-EK193
Varilla de encendedor	R-TKG-EKK0F
Soporte de la varilla	R-TKG-EKK32
Ensamble intercambiador de calor primario de cobre	R-TKG-EK250
Válvula para ajustar flujo/sensor de flujo	R-TKG-EK129
Computadora para TKGHE-38	R-TKG-EK176

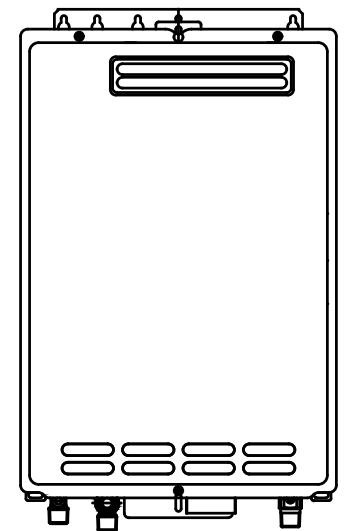
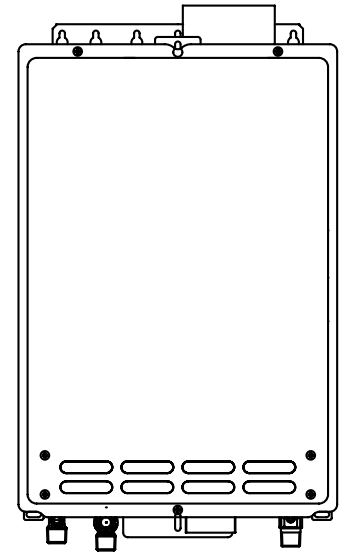

CAJA DE CONTROL QD

REFACCIÓN	HP DE CAJA DE CONTROL			CÓDIGO
	1/2	3/4	1	
CAPACITOR DE ARRANQUE (250-300 MFD)	√			305207951
CAPACITOR DE ARRANQUE (86-103 MFD)		√		305207918
CAPACITOR DE ARRANQUE (105-126 MFD)			√	305207913
RELEVADOR QD AZUL		√		305101903

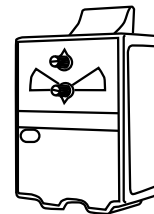

CAJA DE CONTROL INTEGRALES

REFACCIÓN	HP DE CAJA DE CONTROL							CÓDIGO
	1 - 1.5	2	3	5	7.5	10	15	
CAPACITOR DE ARRANQUE (105-126 MFD)	√	√						305206923
CAPACITOR DE ARRANQUE (270-324 MFD)				√	√		√	305208919
CAPACITOR DE ARRANQUE (216-259 MFD)					√	√		305208918
CAPACITOR DE TRABAJO (10 MFD)	√							305204902
CAPACITOR DE TRABAJO (20 MFD)		√						305204903
CAPACITOR DE TRABAJO (35 MFD)						√		305203902
CAPACITOR DE TRABAJO (40 MFD)				√				305203914
CAPACITOR DE TRABAJO (45 MFD)			√		√		√	305203909
BOTÓN RESTABLECEDOR PRINCIPAL (PROT. CONTRA SOBRECARGA) / POSICION IZQ.		√						275411113
			√					305215915
				√				275406102
					√			305214922
BOTÓN RESTABLECEDOR DE ARRANQUE (PROT. CONTRA SOBRECARGA) / POSICION DER.					√			275411107
	√							305215917
		√						305215918
			√					275411102
					√			305214903
RELEVADOR DE ARRANQUE (RELAY)	√	√	√					305213902
				√	√	√		305213961

CONECTORES PARA MOTORES

RANGO HP	DESCRIPCIÓN	CÓDIGO
1/2 - 1.5 HP	CONECTOR PARA MOTOR FRANKLIN DE 4", 48", 2 CABLES	CC42XLPE48
1/2 - 3 HP	CONECTOR PARA MOTOR FRANKLIN DE 4", 48", 3 CABLES	CCT43X48
1/2 - 3 HP	CONECTOR PARA MOTOR FRANKLIN DE 4", 48", 3 CABLES TIPO CLAMP	CCA43X48
5 - 10 HP	CONECTOR PARA MOTOR FRANKLIN DE 4", 100", 3 CABLES	CCT43X100
5 - 10 HP	CONECTOR PARA MOTOR FRANKLIN DE 4", 100", 3 CABLES TIPO CLAMP	CCA43X100
5 - 60 HP	CONECTOR PARA MOTOR FRANKLIN DE 6", 8 FT, 3 CABLES	CC6XLPE13P

OTROS COMPONENTES

HP DE CAJA DE CONTROL	CÓDIGO
KIT TRANSDUCTOR DE PRESIÓN PARA SUBDRIVE 75, 100 Y 150	223995901
APARTARRAYOS MONOFÁSICO FRANKLIN 220 VOLTS.	APT 1F
APARTARRAYOS TRIFÁSICO FRANKLIN	APT



Franklin Electric REFACCIONES MOTORES FRANKLIN ELECTRIC

REFACCIÓN	CÓDIGO	
CAMPANA SUPERIOR	MSF4 1/211152	
	MSF4 1/212302	
	MSF4 3/412302	
	MSF4 112302	
	MSF4 1.512302	
	MSF4 1/21115	
	MSF4 1/21230	
	MSF4 3/41230	
	MSF4 11115	
	MSF4 11230	
	MSF4 1.51230	
	MSF4 21230	
	MSF4 33460	
	MSF4 33230	
	MSF4 33200	
CAMPANA INFERIOR	MSF4 31230	
	MSF4 51230	
	MSF4 1/23230	
	MSF4 1/23460	
	MSF4 3/43230	
	MSF4 3/43460	
	MSF4 13230	
	MSF4 13460	
	MSF4 1.53230	
	MSF4 1.53460	
	MSF4 23230	
	MSF4 23460	
	MSF4 53230	
	MSF4 53460	
	MSF4 7.53230	
MSF4 7.53460		
CAPACITOR SOBRECARGA	MSF4 305974912	
	MSF4 305011905	
	MSF4 305319901	
	MSF4 305011904	
	MSF4 305046904	
	MSF4 305388901	
	MSF4 305974906	
	MSF4 305974909	
	MSF4 305974908	
	MSF4 305974907	
	MSF4 305974904	
	MSF4 305974911	
	MSF4 305974910	
	KIT DE CAMPANAS Y SELLO	MSF4 305974912
		MSF4 305011905
MSF4 305319901		
MSF4 305011904		
MSF4 305046904		
MSF4 305388901		
MSF4 305974906		
MSF4 305974909		
MSF4 305974908		
MSF4 305974907		
MSF4 305974904		
MSF4 305974911		
MSF4 305974910		
TORNILLOS		MSF4 305974912
		MSF4 305011905
	MSF4 305319901	
	MSF4 305011904	
	MSF4 305046904	
	MSF4 305388901	
	MSF4 305974906	
	MSF4 305974909	
	MSF4 305974908	
	MSF4 305974907	
	MSF4 305974904	
	MSF4 305974911	
	MSF4 305974910	

QUIERO COMPRAR





Franklin Electric

REFACCIONES

MOTORES FRANKLIN ELECTRIC

REFACCIÓN	MSF6 7.51230	MSF6 101230	MSF6 151230	MSF6 7.53230	MSF6 7.53460	MSF6 103230	MSF6 103460	MSF6 153230	MSF6 153460	MSF6 203230	MSF6 203460	MSF6 253230	MSF6 253460	MSF6 303230	MSF6 303460	MSF6 403230/SF	MSF6 403460/SF	MSF6 503230	MSF6 503460/SF	MSF6 603460	MSF6 753460/SF	MSF6 753460HT	MSF6 1003460SF	MSF6 1003460HT	MSF6 1253460	MSF6 1253460HT	MSF6 1503460	MSF6 1503460HT	MSF6 1753460	MSF6 2003460	CÓDIGO				
CAJA DE AJUSTE																✓																	305426007		
CAMPANA INFERIOR																																		305428009	
																																		305428029	
																																		305426005	
																																		305428007	
																																		305428026	
CAMPANA SUPERIOR																																		305428003	
																																		177265905	
																																		305428004	
																																		305428023	
																																		305428025	
CAPACITOR SOBRECARGA	✓																																	305388901	
CHUMAZERA																																		305428020	
CONJUNTO DE EMPUJE																																		305428001	
DIAFRAGMA																																		305428010	
KIT SELLO PARA MOTOR																																		305428030	
																																		305428011	
KIT TORNILLOS																																			305428031
SELLO MECÁNICO																																		305428008	
TERMINAL	✓																																	305426017	
	✓																																	305426011	

